



Apple Cinema Display 22" LCD
(ADC)

11 April 2003



Take Apart
Apple Cinema Display 22" LCD (ADC)



Tools

The following tools are recommended for the take apart procedures.

- 2 mm hex key
- #2 Phillips screwdriver
- jeweler's #1 Phillips screwdriver
- ESD wriststrap and mat
- white cotton gloves (922-1592)
- nylon probe tool (922-5065)

Important: The display plastics, inside and out, retain fingerprints and can scratch easily. Be very careful with tools, lay the display and plastic parts only on a clean soft surface, and wear clean white cotton gloves when handling and servicing the display.



Foot Assembly

Tools

This procedure requires the following tools:

- 2 mm hex key
- White gloves for handling plastics

Part Location



Preliminary Steps

Before you begin, do the following:

- Place the display face down on an ESD mat or soft cloth

Note: Plastics are easily damaged. The white gloves prevent fingerprints.

Procedure

1. Remove three hex screws.
2. Lift the foot off the hinge.



3. The clear hinge cap may fall off the foot. If it doesn't, remove it from the foot.



4. Pull the ADC (Apple Display Connector) cable through the opening in the foot to separate the foot and the cable.



Rear Cover

Tools

This procedure requires the following tools:

- 2 mm hex key
- White gloves for handling plastics

Note: Plastics are easily damaged. The white gloves prevent fingerprints.

Part Location



Preliminary Steps

Before you begin, do the following:

- Place the display face down on an ESD mat
- Remove the foot assembly

Procedure

1. Remove eighteen hex screws on the rear cover.



2. Lift the rear cover slightly and disconnect the power/brightness switch cable connector, shown below. Carefully pull the ADC cable through the rear cover.

Note: The power/brightness switch board is permanently attached to the rear cover and cannot be removed.

Replacement Note: Verify that the clear plastic USB cover is in place over the USB socket, and that the USB icon arrows point up.





Tools

This procedure requires the following tools:

- #2 Phillips screwdriver

Part Location



Preliminary Steps

Before you begin, do the following:

- Place the display face down on an ESD mat
- Remove the foot assembly
- Remove the rear cover

Procedure

1. Remove four screws. **Note:** Two of the screws are yellow. These screws are for the ADC cable.



2. Pull the ADC cable out of the way and remove two more hinge screws.
3. Lift the hinge up and off the chassis.

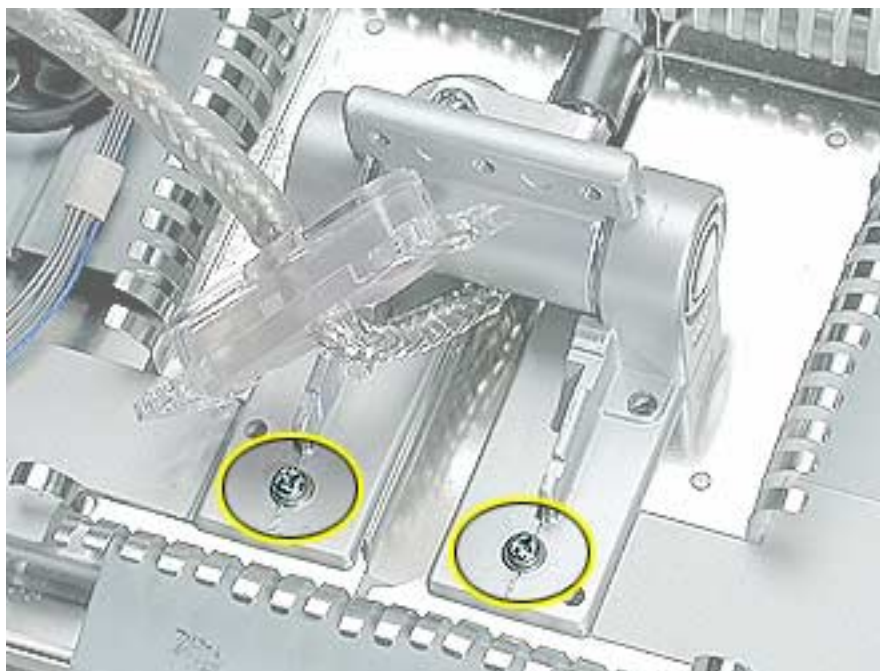

Replacement Note: The hinge has locators on it, so it seats correctly in the chassis.



Main Board Shield

Tools

This procedure requires the following tools:

- #2 Phillips screwdriver

Part Location

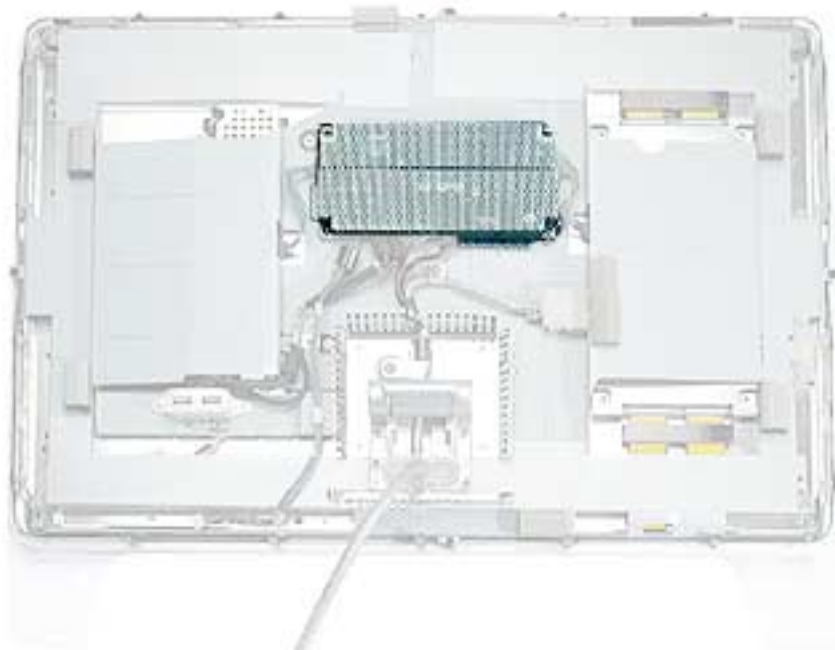

Preliminary Steps

Before you begin, do the following:

- Place the display face down on an ESD mat
- Remove the foot assembly and hinge cover
- Remove the rear cover

Procedure

1. Remove four screws holding the main board shield.

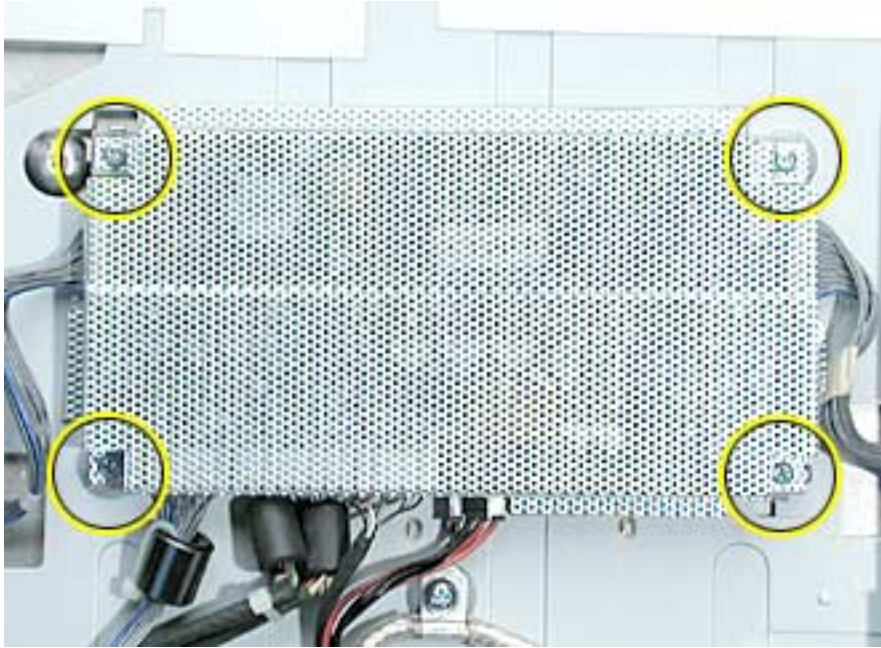

2. Lift the shield from the main board.

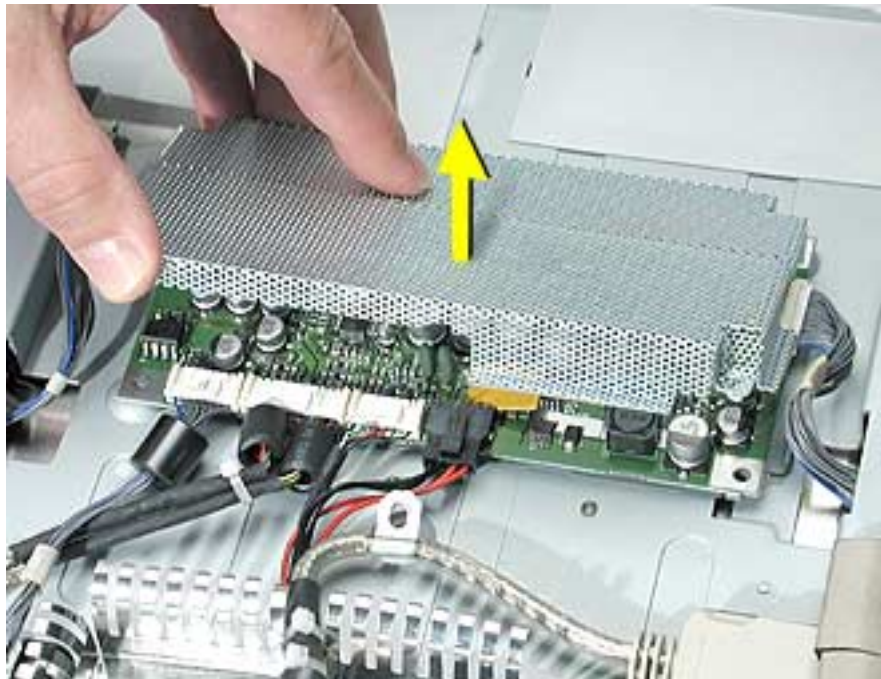



ADC Cable

Tools

This procedure requires the following tools:

- #2 Phillips screwdriver

Part Location



Preliminary Steps

Before you begin, do the following:

- Place the display face down on an ESD mat
- Remove the foot assembly and hinge cover
- Remove the rear cover
- Remove the hinge
- Remove the main board shield

Procedure

1. Remove two screws holding the ADC cable clips.

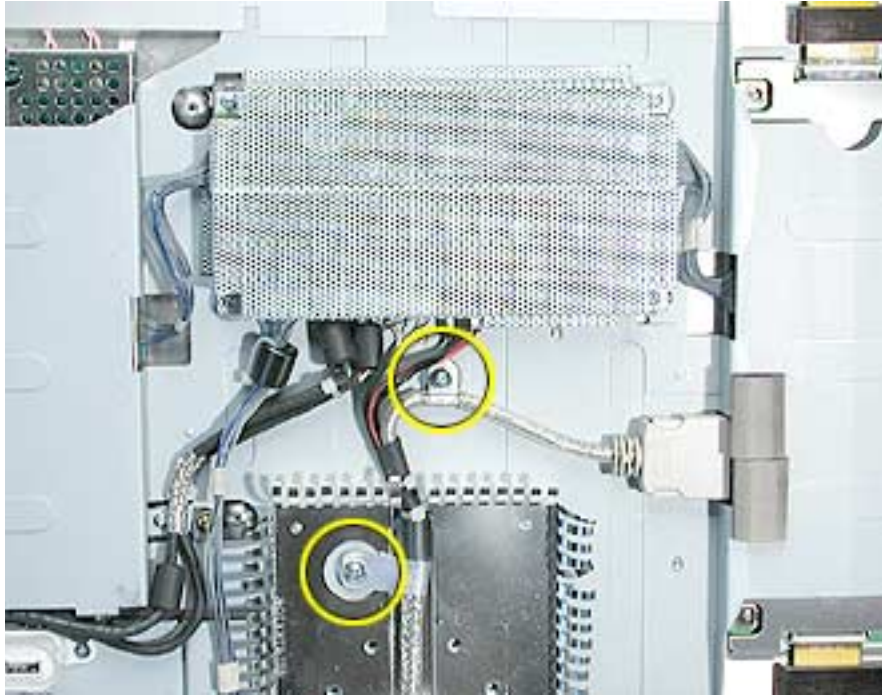

2. Disconnect the connectors from the ADC cable at the main board and to the display panel, then remove the ADC cable.

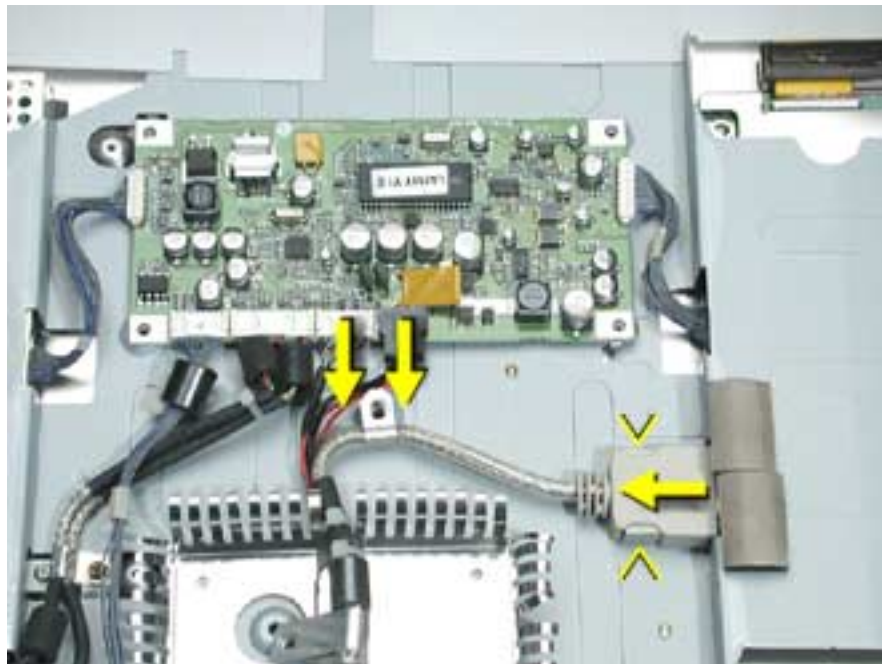



USB Cable

Tools

This procedure requires the following tools:

- #2 Phillips screwdriver

Preliminary Steps

Before you begin, do the following:

- Place the display face down on an ESD mat
- Remove the foot assembly and hinge cover
- Remove the rear cover
- Remove the main board shield

Procedure

1. Remove the clear plastic USB cover from the USB socket for transfer to the replacement cable. **Note:** When replacing, verify that the USB icon arrows point up.
2. Remove the two USB socket screws.
3. Remove the USB cable clip screw.
4. Disconnect the USB cable from the main board, and remove the USB cable.

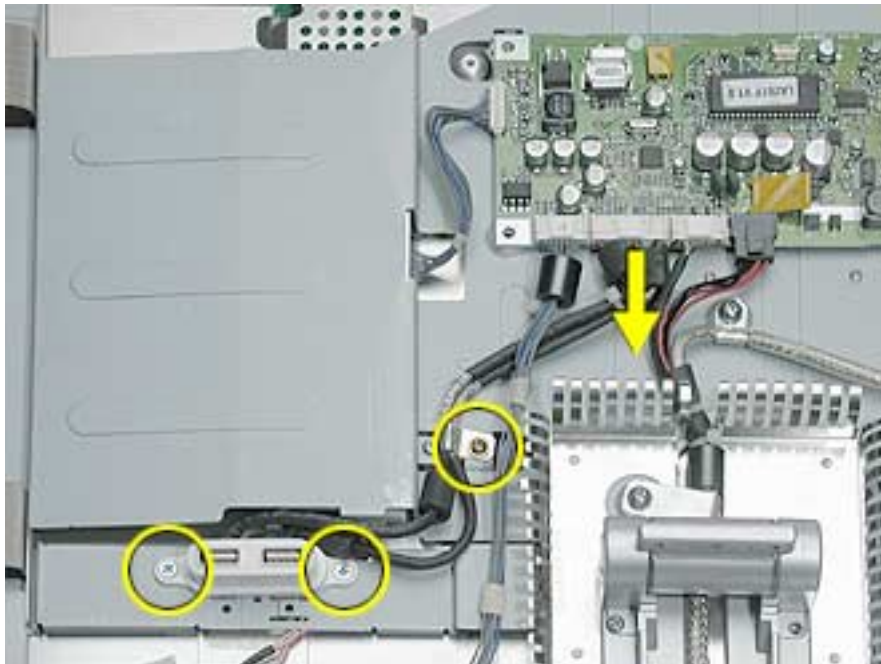



Main Board

Tools

This procedure requires the following tools:

- #2 Phillips screwdriver

Part Location

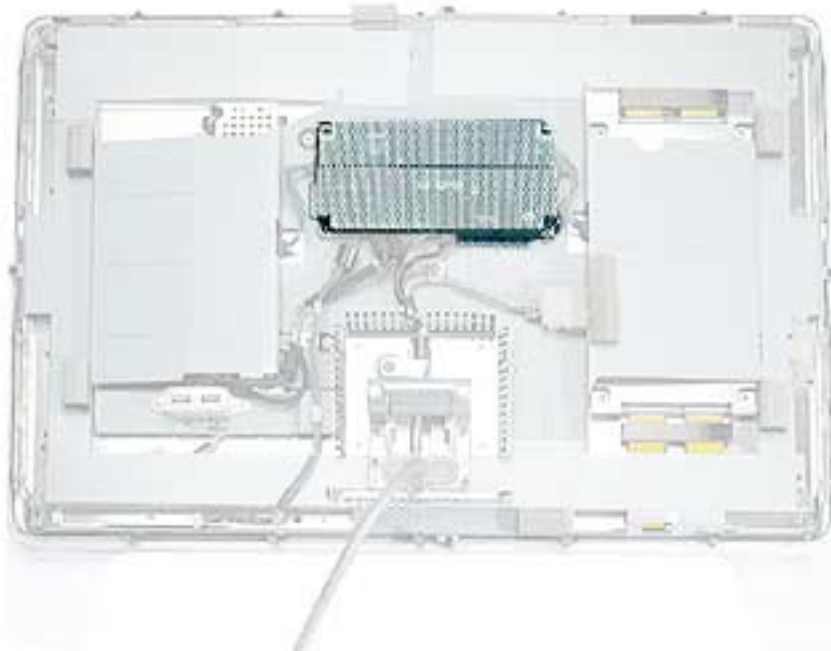

Preliminary Steps

Before you begin, do the following:

- Place the display face down on an ESD mat
- Remove the foot assembly and hinge cover
- Remove the rear cover
- Remove the main board shield

Procedure

1. Disconnect the six connectors attached to the main board and remove the board.

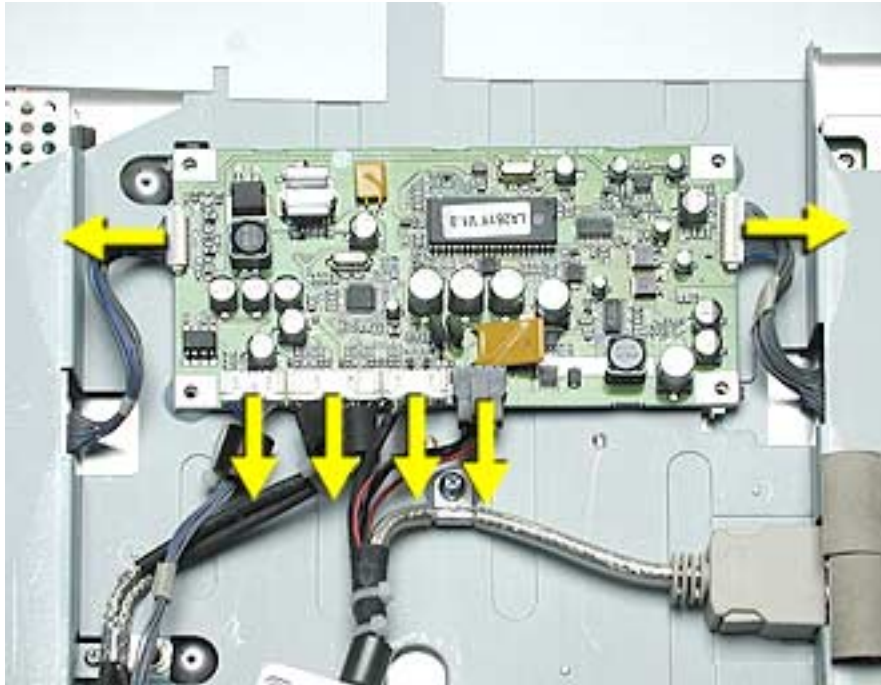



Front Bezel

Tools

This procedure requires the following tools:

- #2 Phillips screwdriver

Preliminary Steps

Before you begin, do the following:

- Place the display face down on an ESD mat
- Remove the foot assembly and hinge cover
- Remove the rear cover

Procedure

1. Remove the four bezel screws.

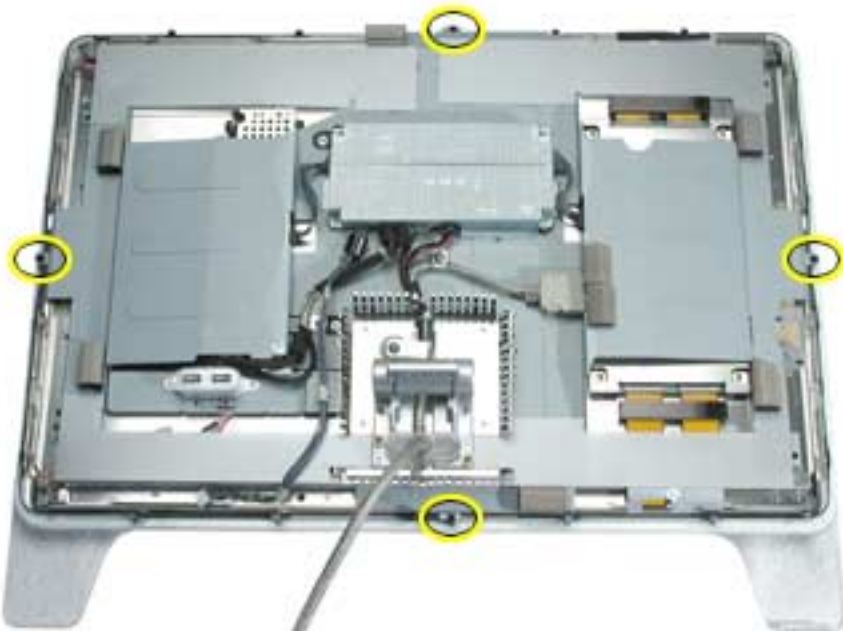

2. Lift the panel and chassis assembly off the bezel.

Important: The display panel is very heavy. Use caution when lifting the panel out of the bezel.

Note: The picture below illustrates removal of the display panel, you do not need to remove the items not shown.





Chassis

Tools

This procedure requires the following tools:

- #2 Phillips screwdriver

Part Location

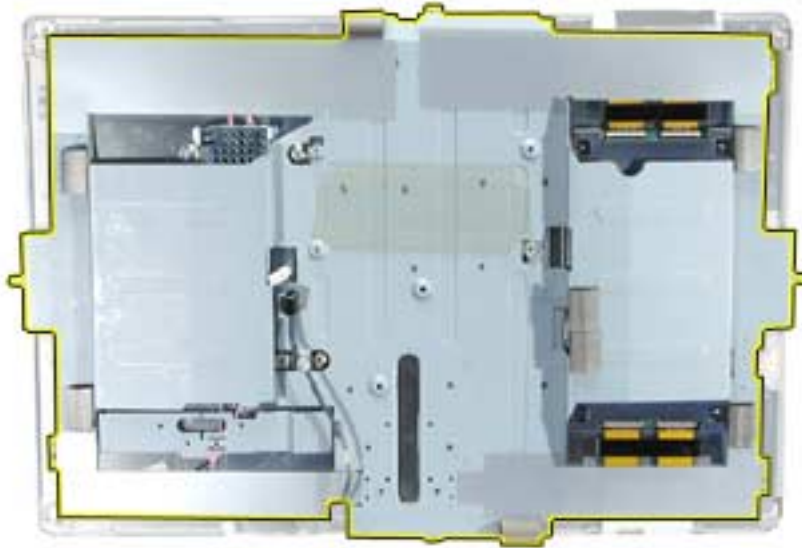

Preliminary Steps

Before you begin, do the following:

- Place the display face down on an ESD mat
- Remove the foot assembly and hinge cover
- Remove the rear cover
- Remove the hinge
- Remove the main board and shield
- Remove the ADC cable and shield
- Remove the USB cable
- Remove the front bezel.

Procedure

1. Remove the two side screws located at the top and bottom of the display.
2. Remove the four corner screws.

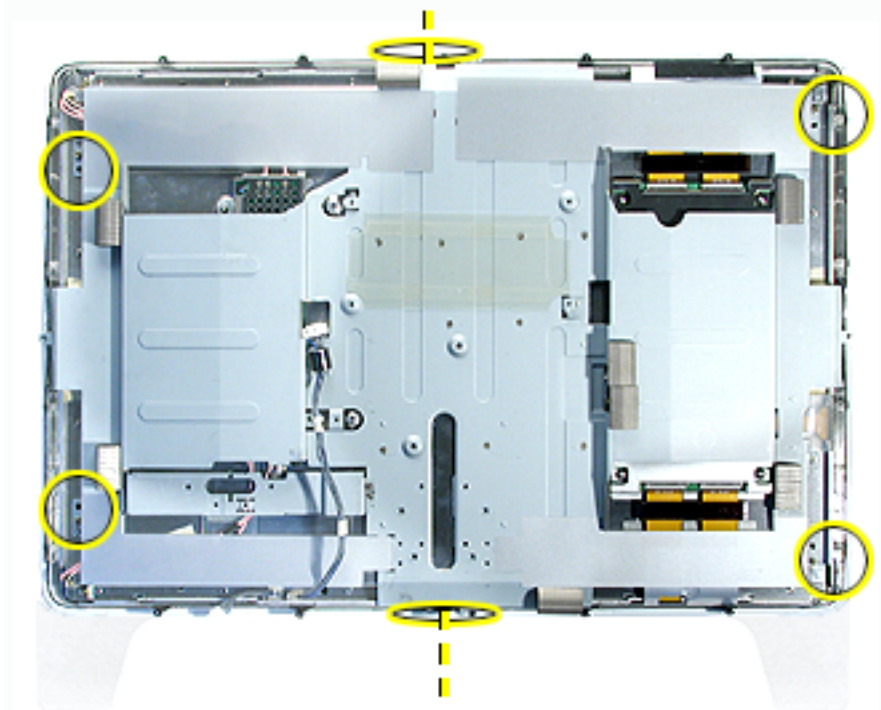

3. Hold the metal chassis on each side and lift it straight up.



Inverter Board

Tools

This procedure requires the following tools:

- #2 Phillips screwdriver

Preliminary Steps

Before you begin, do the following:

- Place the display face down on an ESD mat
- Remove the foot assembly and hinge cover
- Remove the rear cover
- Remove the front bezel.
- Disconnect the cable connector from the main board to the inverter board
- Disconnect the cable connector from the main board to the display panel
- Disconnect the cable connector from the ADC cable to the display panel
- Remove the chassis from the display panel

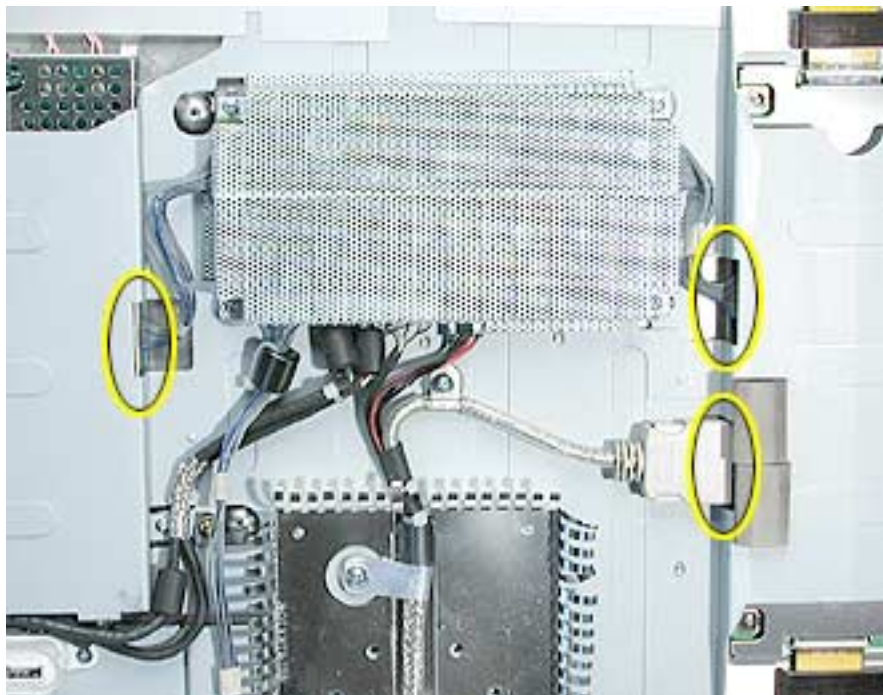

Procedure

1. Disconnect the backlight bulb wire connectors from the inverter board.
2. Remove the three screws from the inverter shield.

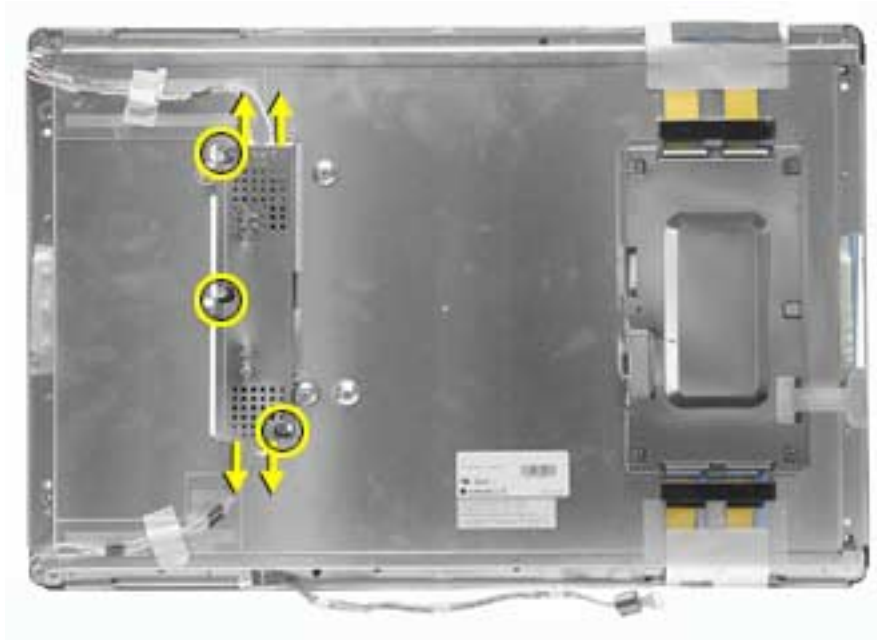

3. The inverter shield has small catches inside that secure the inverter board. Pull back slightly on the sides of the shield to release the board.

Replacement Note: Make sure that the board is secured by the four catches on the shield.





Display Panel

Tools

This procedure requires the following tools:

- #2 Phillips screwdriver
- nylon probe tool (922-5065)

Preliminary Steps

Before you begin, do the following:

- Place the display face down on an ESD mat
- Remove the foot assembly and hinge cover
- Remove the rear cover
- Remove the front bezel.
- Disconnect the cable connector from the main board to the inverter board
- Disconnect the cable connector from the main board to the display panel
- Disconnect the cable connector from the ADC cable to the display panel
- Remove the chassis from the display panel
- Disconnect the backlight bulb wire connectors (top and bottom) from the inverter board
- Remove the inverter board

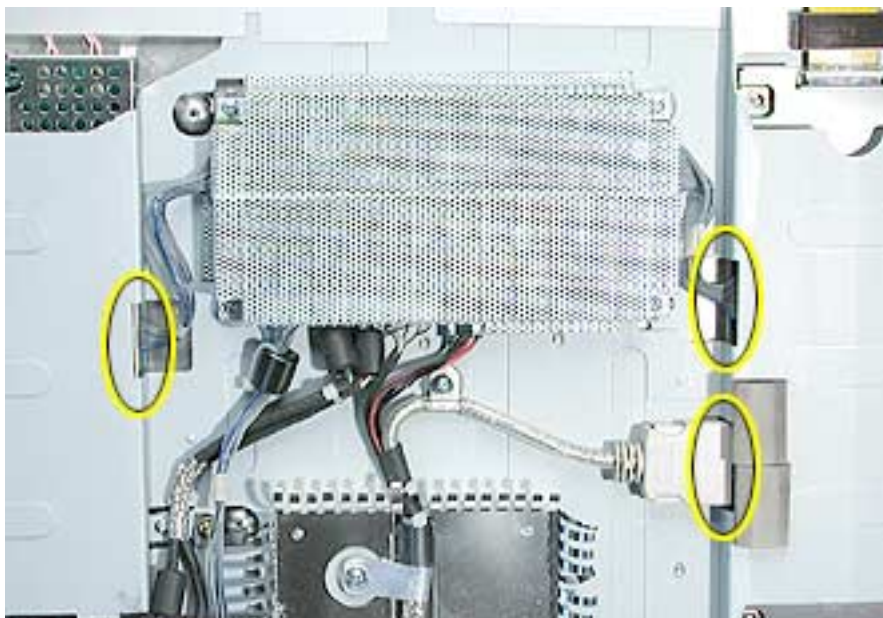

Procedure

1. Remove the two screws on the inverter board bracket and remove the bracket.
2. Use the nylon probe tool to carefully spread the securing clip and remove the power/brightness switch cable.

Replacement Note: Install the inverter board bracket with the arrow up.

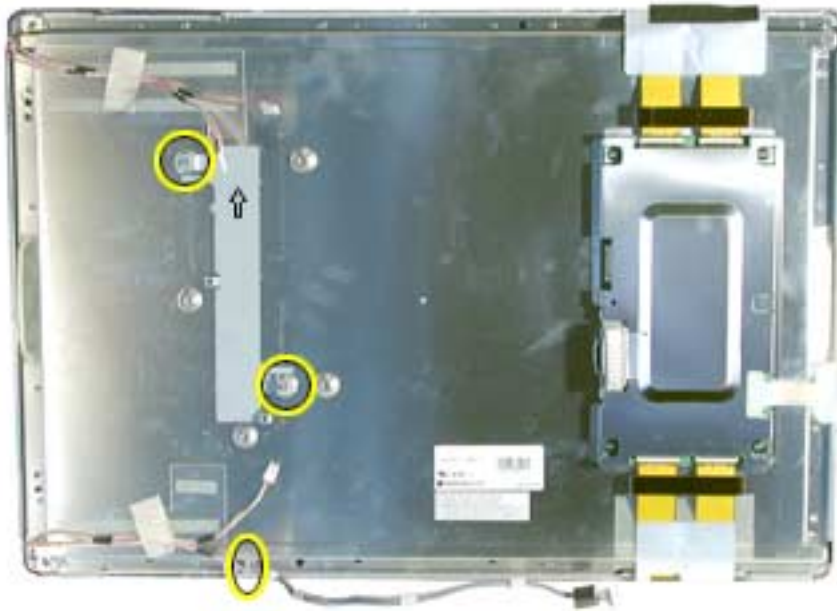

Important: The backlight bulbs must be returned with the display panel.



Top Backlight Bulb

Tools

This procedure requires the following tools:

- jeweler's #1 Phillips screwdriver
- white cotton gloves (to prevent fingerprints on the bulbs and reflector)

Part Location

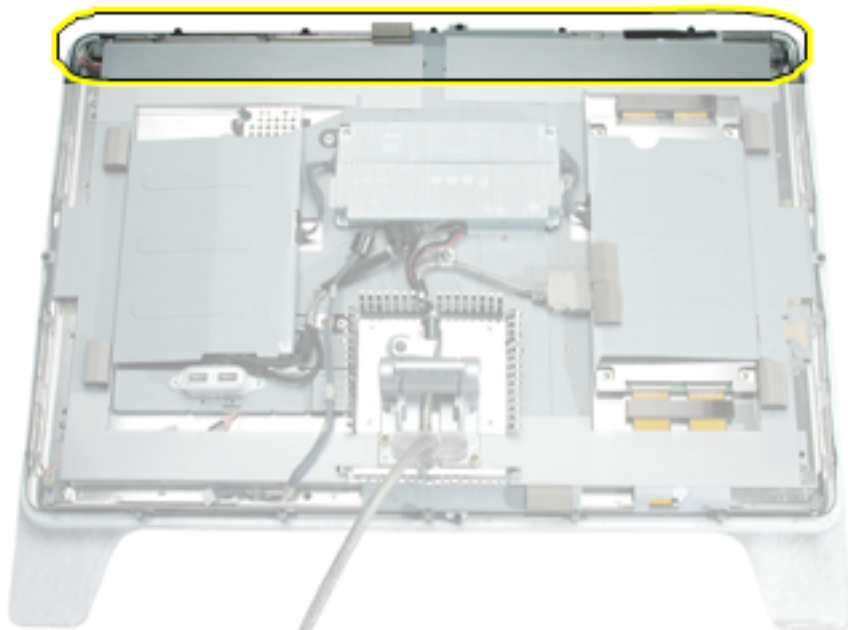

Preliminary Steps

Before you begin, do the following:

- Place the display face down on an ESD mat
- Remove the foot assembly and hinge cover
- Remove the rear cover
- Remove the front bezel.

Procedure

1. Peel the gray Mylar tape back on the chassis to expose the backlight bulb wires.
2. Disconnect the two top bulb wire connectors from the inverter board and peel back the tape to release the wires.
3. Remove the bulb screw.

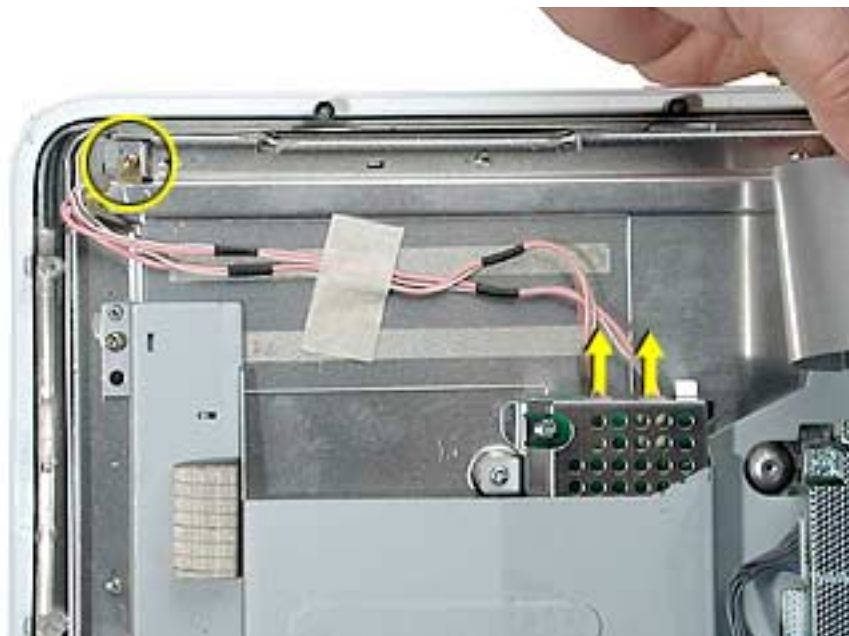

4. Put on cotton gloves, then carefully slide the bulb tray out of the panel.

Important: The bulbs are very fragile. Handle with care.

Note: The bulbs are interchangeable top and bottom.

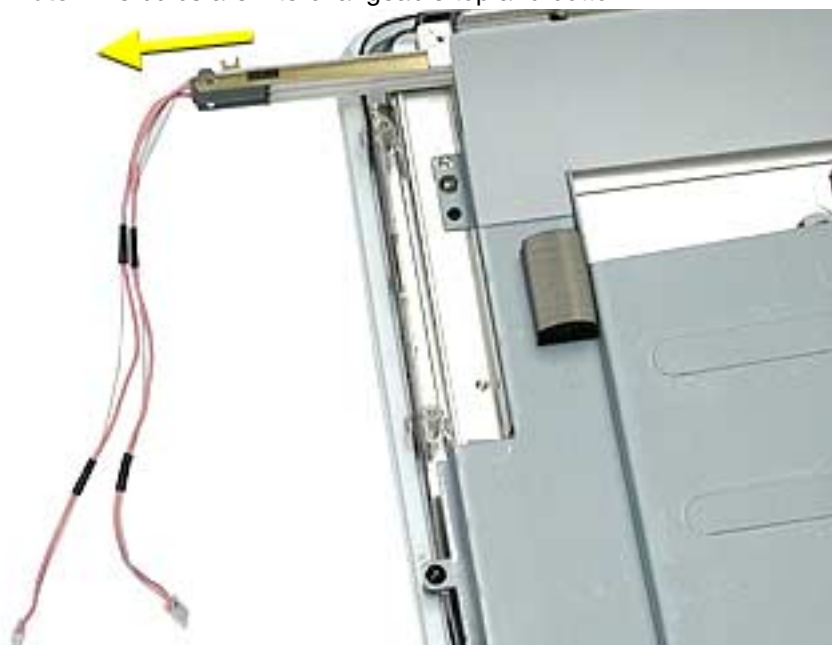



Bottom Backlight Bulb

Tools

This procedure requires the following tools:

- jeweler's #1 Phillips screwdriver
- white cotton gloves (to prevent fingerprints on the bulbs and reflector)

Part Location



Preliminary Steps

Before you begin, do the following:

- Place the display face down on an ESD mat
- Remove the foot assembly and hinge cover
- Remove the rear cover
- Remove the front bezel.
- Disconnect the cable connector from the main board to the inverter board
- Disconnect the cable connector from the main board to the display panel
- Disconnect the cable connector from the ADC cable to the display panel
- Remove the chassis from the display panel

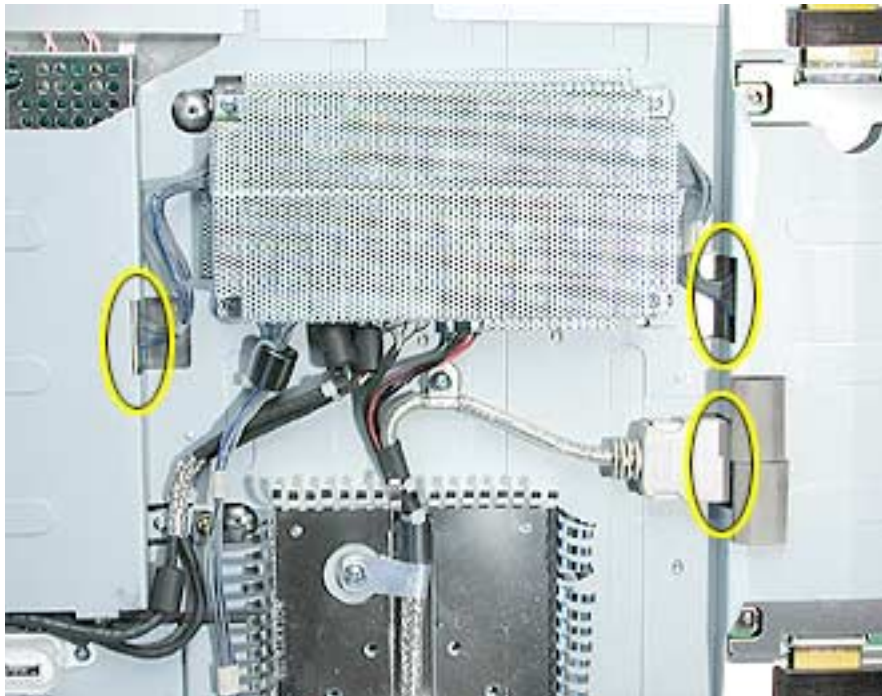

Procedure

1. Disconnect the two bottom bulb wire connectors from the inverter board and peel back the tape to release the wires.
2. Remove the bulb screw.
3. Put on cotton gloves, then carefully slide the bulb tray out of the panel.

Important: The bulbs are very fragile. Handle with care.

Note: The bulbs are interchangeable top and bottom

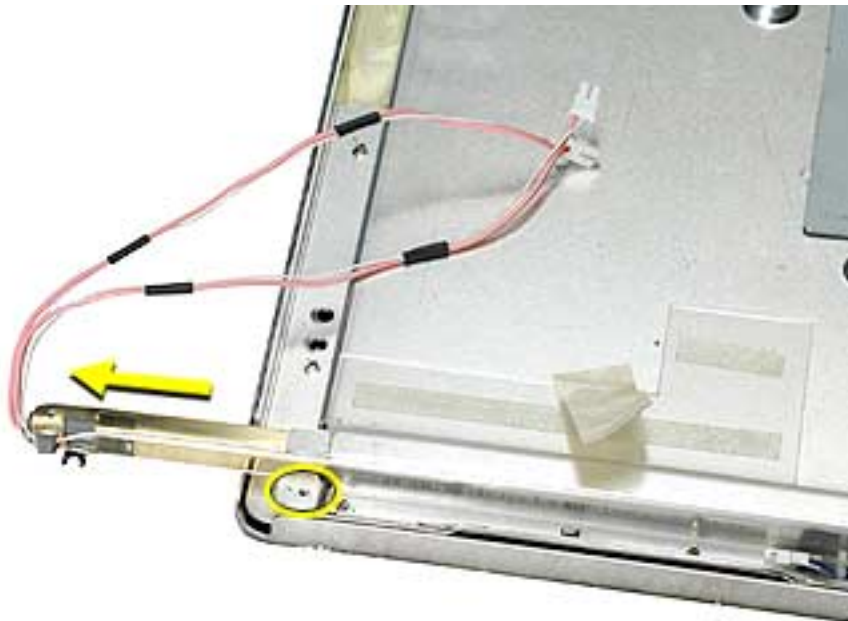



Troubleshooting
Apple Cinema Display 22" LCD (ADC)



Symptom Charts

How to Use the Symptom Charts

The Symptom Charts included in this chapter will help you diagnose specific symptoms related to the product. Because cures are listed on the charts in the order of most likely solution, try the cures in the order presented. Verify whether or not the product continues to exhibit the symptom. If the symptom persists, try the next cure.

Note: If you have replaced a module, reinstall the original module before you proceed to the next cure.

Note: Referring to the Block Diagram in this manual may be helpful.

Blank screen

This symptom may indicate a problem with the LCD panel, backlight bulbs, inverter, main board, or related cables or connectors.

1. Check ADC cable. Replace cable if damaged.
2. Check for bent pins in the ADC connector (note, it is normal for two of the pins to be slightly longer than the others). If pins are slightly bent, carefully straighten. If pins are severely bent, replace cable. Also, inspect or have the customer inspect the display port on the computer for broken pin dividers. If the display port is damaged it must be repaired before inserting the ADC connector.
3. Plug the display into a known-good computer with a known-good video card and ADC display port. Boot the computer and allow enough time to finish booting.
4. If the power button on the display is flashing, two short flashes then a long flash, in a delayed repeating pattern, this indicates trouble with either the inverter, backlight bulbs or related cables or connectors. With this in mind, continue with the troubleshooting steps to determine the problem.

-
5. To check whether the LCD is working, make sure that the display's power light is on (glows white). Shine a bright light such as sunlight or a high intensity lamp (see Important note, below) into the screen and at the same time notice whether you can see faint images of desktop items on the screen.
 - If desktop items can be seen, the LCD panel is working. The problem may be with the inverter or backlight bulbs or related cables or connectors. Continue with the troubleshooting steps.
 - If no desktop items can be seen, the problem may be with the LCD panel or the main board or related cables or connectors.

Important: Lights get very hot and can quickly damage the display; be extremely careful not to allow too much heat next to the screen or other parts of the display and do not allow the light fixture to touch the screen, or damage can result.

6. **Warning: The inverter board generates high voltage when the display is plugged in. Do not touch the inverter board components, pins or connectors, when the display is connected to the computer.**

Disconnect the display from the computer, then open the display and check for secure connections at J2, J5, J6, J4, J3 and the ADC cable connection to the panel.

Note: Refer to the Block Diagram in this manual for connector locations.

7. Plug the display into a known-good computer, then boot the computer.
8. Verify +24-28V at pin 1 of J4. If not, replace ADC cable.
9. Verify +15V at pin 1 of J2. If not, replace the main board.
10. Verify +5V at pin 1 of J5. If not, replace the main board.

Partially dim screen

This symptom indicates a problem with the inverter or backlight bulbs (on the side of the display that is dim), or related cables or connectors. This may be caused by the backlight bulbs or the inverter not working properly.

1. Plug the display into a known-good computer with a known-good video card and ADC display port. Boot the computer.
2. Notice whether the power button on the display is flashing, two short flashes then a long flash, in a delayed repeating pattern. This indicates trouble with either the inverter, backlight bulbs or related cables or connectors (this indicator may not always be exhibited). With this in mind, continue with the troubleshooting steps to determine the problem.
3. **Warning: The inverter board generates high voltage when the display is plugged in. Do not touch the inverter board components, pins or connectors, when the display is connected to the computer.**

Disconnect the display from the computer, then open the display and check for secure connections where the backlight bulbs plug into the inverter.

Note: Refer to the Block Diagram in this manual for connector locations.

4. **Important:** The backlight bulbs are extremely delicate. Handle with care.

To determine whether the problem is with the backlight bulbs or the inverter board, disconnect the two CN connectors to the backlight bulbs on the side that is dim. Connect the CN connectors to a known good backlight bulb tray (the bulb tray from the other side of the display can be removed and plugged in to test, if known good). Connect the display's ADC connector to a known-good computer, then boot the computer. If one or more of the bulbs does not light, replace the inverter. If the bulbs light correctly, the original backlight bulb tray is bad, replace the bulb tray.

Note: The top and bottom backlight bulb trays are interchangeable. The bulb trays are not specific to the top or bottom.

USB device not working

1. Check for bent pins in the ADC connector (note, it is normal for two of the pins to be slightly longer than the others). If pins are slightly bent, carefully straighten. If pins are severely bent, replace cable. Also, inspect or have the customer inspect the display port on the computer for broken pin dividers. If the display port is damaged it must be repaired before inserting the ADC connector.
2. Plug the display into a computer with a known-good ADC display port, then boot the computer. On the back of the display, connect a known-good USB device into one of the USB ports, then check Apple System Profiler to see if it is recognized. Check both USB ports.

Note: ⌘+R, refreshes the Apple System Profiler list when USB devices are changed.

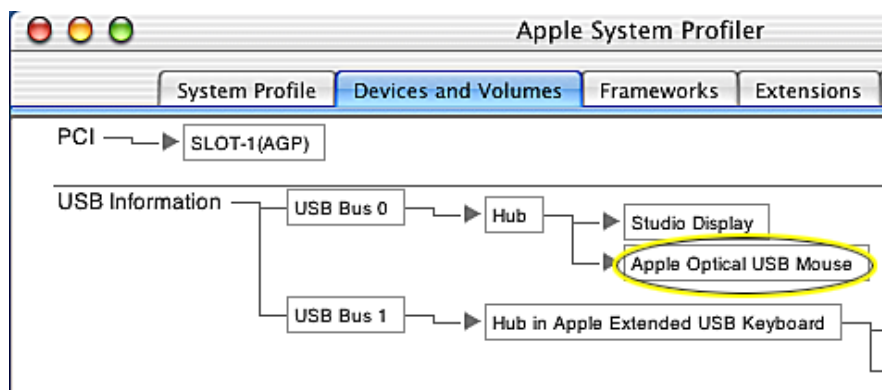

- If the device is recognized, the customer's USB device may be the issue.
- If not, check the J1 USB connections and cables. If not that, replace the main board.

Power/brightness switch not working

1. Check J5 connection and verify that the cable is connected to the power/brightness switch cable connector.
2. Replace the rear cover (includes power/brightness switch board).

Note: The power/brightness switch board is permanently attached to the rear cover.

3. Replace main board.

When displaying a single color over the screen area, the LCD panel shows one or more pixels that are not properly lit

Active-matrix LCD technology uses rows and columns of addressable locations (pixels) that render text and images on screen. Each pixel location has three separate subpixels (red, green, and blue) that allow the image to be rendered in full color. Each subpixel has a corresponding transistor responsible for turning the subpixel on or off.

There are typically millions of these subpixels on an LCD display. For example, the LCD panel used in the Apple Cinema HD display is made up of 2.3 million pixels and 6.9 million red, green, and blue subpixels. Occasionally, a transistor does not work perfectly, which may result in the affected subpixel being turned on (bright) or turned off (dark). With the millions of subpixels on a display, it is quite possible to have a low number of faulty transistors on an LCD. Therefore, a certain number of subpixel anomalies is considered acceptable. Rejecting all but perfect LCD panels would significantly increase the retail price for products using LCD displays. These factors apply to all manufacturers using LCD technology—not just Apple products.

To determine whether or not the display has an acceptable number of pixel anomalies, follow the steps below:

1. Set the display image to one of the following colors: all-white display, all-red display, all-green display, or all-blue display.

Note: Knowledge Base article 112125: Service Diagnostics Matrix, has the LCD Tester Diagnostic Utility that will generate these patterns on the screen.

2. Using a jeweler's loupe, pocket microscope, or other magnifying device, identify and count each subpixel anomaly:
 - Bright subpixel anomaly = subpixel that is always on
 - Dark subpixel anomaly = subpixel that is always off
3. **Important:** Check the number of subpixel anomalies with the following chart:

Acceptable Number of Subpixel Anomalies			Replace the Display		
Bright	Dark	Combination	Bright	Dark	Combination
up to 8	up to 10	up to 15	8 or more	11 or more	16 or more

4. If the number of subpixel anomalies exceeds the acceptable number listed in the chart, replace the display panel.
5. If the number of subpixel anomalies is acceptable, explain to the customer that the pixel anomalies are within specifications, and no repair is necessary.

Important: Do not release the specifications to customers. Instead, inform them that a certain number of subpixel anomalies is considered acceptable, and these factors apply to all manufacturers using LCD technology—not just Apple products.

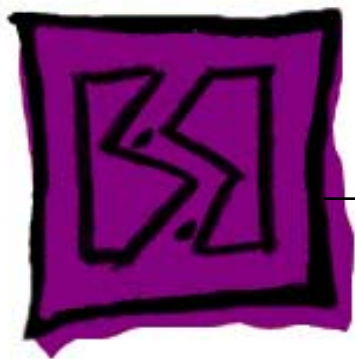

Views

Apple Cinema Display 22" LCD (ADC)

Block Diagram

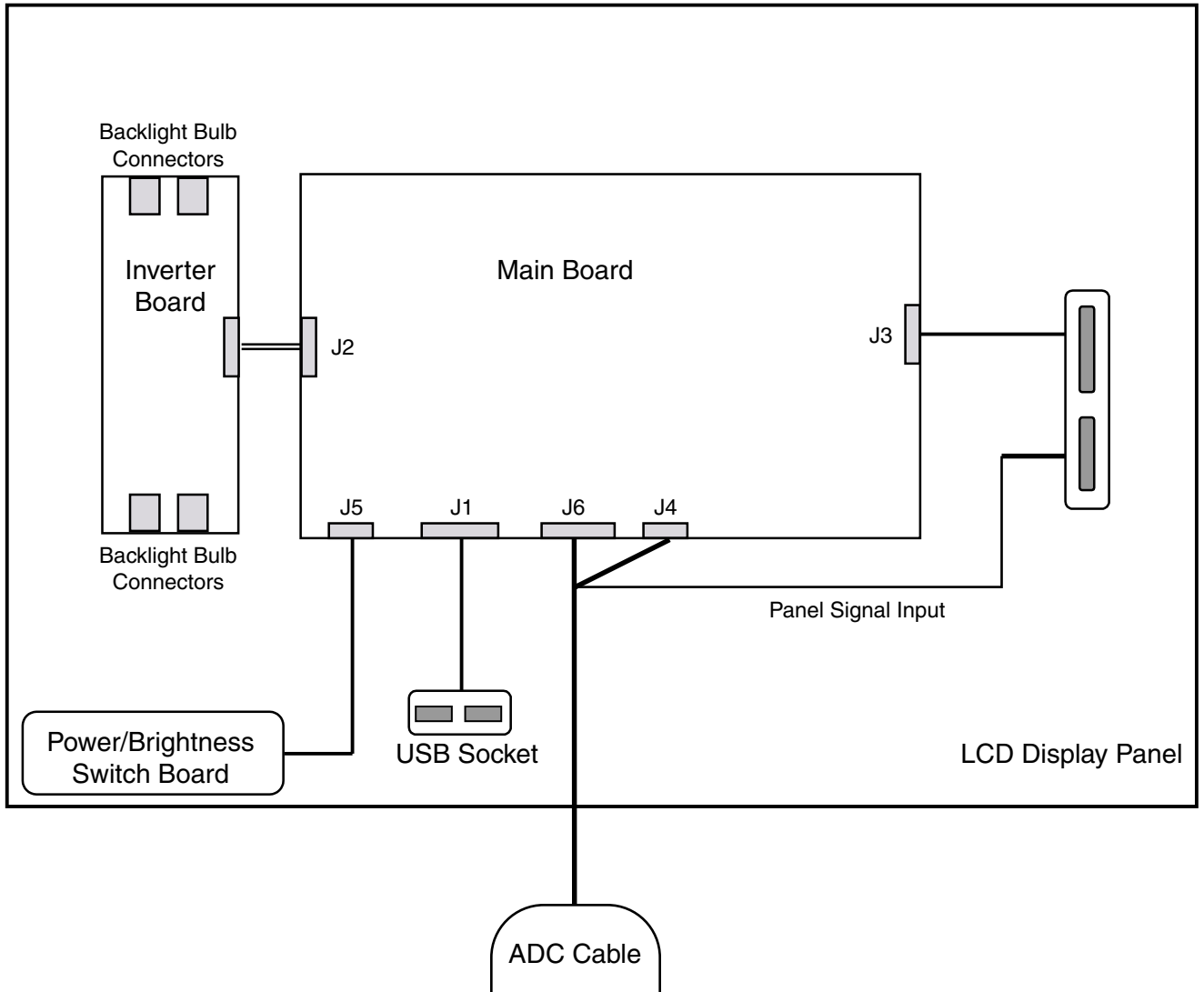

Exploded View

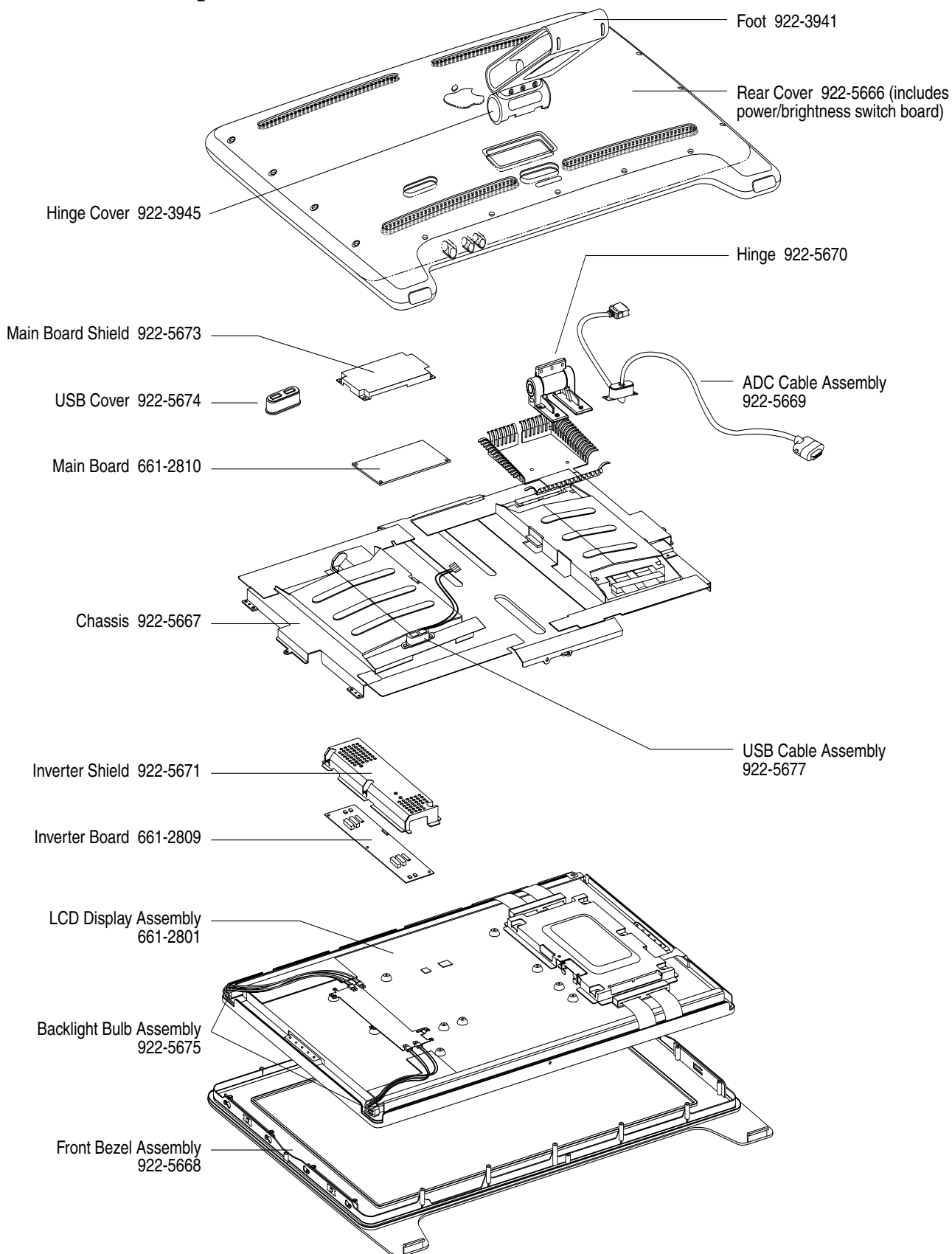

Screw Matrix

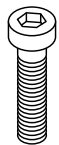

13 mm Hex

922-5679 Foot (3)

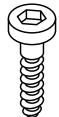

10 mm Hex

922-5680 Rear Cover (18)



10 mm Phillips (black)

922-3541 Chassis to Bezel (4)



8 mm Phillips (flat head)

922-5681 Chassis sides (2)



10 mm Phillips (washer)

922-5682 Chassis corners (4)



6 mm Phillips

922-5135 Main board shield (4)



5 mm Phillips (flat head)

922-5640 USB socket (2)



8 mm Phillips (lock washer)

922-5683 ADC cable clips (2)



6 mm Phillips (yellow, lockhead)

922-5684 USB cable clip (1)



10 mm Phillips (yellow, lockhead)

922-5641 ADC cable bracket (2)



6 mm Phillips

922-5685 Hinge to chassis (4)



4 mm Phillips

922-5605 Inverter board shield (3)



5 mm Phillips

922-5686 Inverter board bracket (2)