

---

Service Source



MacBook Pro  

---

(17-inch & 17-inch Core 2 Duo)

13 November 2006

---

# MacBook Pro

## (17-inch & 17-inch Core 2 Duo)

### Contents

#### Basics

General Information	6
Product View	6
Overview	6
New Parts and Procedures	8
Serial Number and Ethernet ID	14
Tools	14
Electrostatic Discharge (ESD)	15
Service Manual Note	15
Kapton® Tape Note	15
Cable Routing Note	15
Screw Measurement and Callout Note	15
Temperature Concerns	15

#### Take Apart

Foot	17
Battery	20
Memory	22
Replacement Procedure	25
Top Case	27
Replacement Procedure	32
Keyboard	38
Replacement Procedure	51
AirPort Extreme Card	60
Hard Drive	65
Bluetooth Card and Antenna	69
Infrared Board	75
Replacement Procedure	77

---

Optical Drive	79
Replacement Procedure	84
Backup Battery	85
Ambient Light Sensors	89
Speakers and Microphone	91
Left I/O Board	97
ExpressCard Cage	103
Fans	104
Logic Board	110
Replacement Procedure	119
Battery Cable Assembly	126
Thermal Sensors	128
Heatsink	132
Bottom Case	134
Display Assembly	136
Replacement Procedure	140

## **Troubleshooting**

General Information	144
Wire and Flex Cables	144
Microphone and Camera wires	145
Hardware Diagnostics	145
Troubleshooting Aids and Tips	147
Software Troubleshooting Tips and Tools	149
Application compatibility	150
Universal binary	150
Rosetta	150
Hardware Symptoms	153
How to Use the Symptom Charts	153
Startup	153
AirPort Extreme	158
Battery	159
Bluetooth	161
Display	162
ExpressCard/34	163

---

Hard Drive 164  
Apple Remote 165  
Infrared Board 165  
Built-in iSight Camera 166  
Keyboard 167  
Microphone 168  
Modem (External) 169  
Ports 171  
Sound 174  
Trackpad 175  
Misc. Symptoms 177

## **Views**

MacBook Pro (17-inch) Exploded View 180  
MacBook Pro (17-inch Core 2 Duo) Exploded View 181  
Screw Chart 182  
Architecture 183

---

# Service Source



## Basics

MacBook Pro  
(17-inch & 17-inch Core 2 Duo)



# General Information

## Product View



## Overview

Both the MacBook Pro (17-inch) and MacBook Pro (17-inch Core 2 Duo) represent the a new generation of MacBook Pro professional notebooks. The original MacBook Pro (17-inch) is built upon the Intel Core Duo chip, while the new MacBook Pro (17-inch Core 2 Duo) is based upon the more recent Intel Core 2 Duo chip, increasing processor speeds to 2.33GHz.

In comparing the MacBook Pro (both the 17-inch and the 17-inch Core 2 Duo) to the previous generation of 17-inch aluminum PowerBook G4s, they may have a similar look, but only the power cord and power adapter AC plug are the same.

The exterior of the new MacBook Pro (17-inch Core 2 Duo) differs from the preceding MacBook Pro (17-inch) in one small but clever way. The LED for the iSight camera no longer depends on opening in the display bezel to be visible.

---

Also new is a MagSafe Airline Adapter, available for both the MacBook Pro (all models) and the MacBook (all models). The MagSafe Airline Adapter fits into the EmPower port nearest your airline seat. Some airlines may have 20 mm in-seat ports that require the use of an additional adapter (included in the kit).



## What's New

Main feature differences between the MacBook Pro (both models) and the PowerBook G4 (17-inch Double-Layer SD):

For details go to [http://support.apple.com/specs/macbookpro/MacBook\\_Pro\\_17-inch.html](http://support.apple.com/specs/macbookpro/MacBook_Pro_17-inch.html).

- Intel Core Duo (2.16GHz) and Core 2 Duo (2.33GHz) microprocessor architecture (over seven times faster than PowerBook G4)
- Higher resolution 17 inch display, 1680 x 1050, 116 dpi (previously 1440 x 960, 114 dpi) with new glossy display option
- Supports PC-5300 DDR2 (667MHz) memory—up to 2GB in the MacBook Pro (17-inch) and up to 3GB in the MacBook Pro (17-inch Core 2 Duo)
- 256MB VRAM with dual link DVI option is standard
- 120GB 5400 RPM hard drive standard in the MacBook Pro (17-inch) and 160GB standard in the MacBook Pro (17-inch Core 2 Duo); 100GB 7200 RPM optional in both models, plus 200GB 4200 RPM optional in the MacBook Pro (17-inch Core 2 Duo) only
- Three USB ports (two on the left side of the system)
- No built-in modem, but supports the optional Apple USB modem
- ExpressCard/34 expansion card slot replaced PCMCIA
- Infrared sensor
- iSight camera built in
- MagSafe magnetic power connector
- Enhanced speaker system (four speaker drivers)

Main service and feature differences between MacBook Pro (17-inch) and MacBook Pro (17-inch Core 2 Duo):

- Intel Core 2 Duo chip increases speeds from 2.16 GHz to 2.33GHz
- Up to 3GB DDR2 memory now supported vs 2GB in the previous model
- 160GB standard hard drive vs 120GB standard in the previous model
- 3-wire Airport antenna vs 2-wire antenna in the previous model
- New trackpad-enabled zooming feature

---

## New Parts and Procedures

This section not only compares the new MacBook Pro (17-inch Core 2 Duo) to the previous MacBook Pro (17-inch), but as a combined manual for both MacBook Pro 17-inch models, it may also reiterate how they differ from previous PowerBook G4 17-inch models. Unless specified, comments can be applied to both 17-inch MacBook Pro models.

### Main Logic Board

The hallmark of the MacBook Pro (17-inch) and MacBook Pro (17-inch Core 2 Duo) is the Intel Core Duo and Core 2 Duo chip, respectively, each with a ATI Mobility Radeon x1600 graphics chip. The microprocessor is soldered to the main logic board. It is not upgradable.

All ports in both MacBook Pro 17-inch models remain the same. The port differences between the MacBook Pro and the PowerBook G4 include: the MagSafe power port and second USB port on the left, as well as ExpressCard/34 replacing what was previously a PCMCIA card slot. The security lock slot is on the right side of the system. Due to all the port re-arrangements, the new logic boards will not fit in any Macintosh 17-inch PowerBook G4s or vice versa. Composite and S-video connections are now only available using an optional Apple DVI to Video adapter.

The boot architecture of the MacBook Pro is based on Extensible Firmware Interface (EFI), replacing Open Firmware (OF) of PowerBook G4 days. Boot snag keys such as “C” for boot from the optical drive, “N” for network boot, and “T” for Target Disk Mode stay the same under EFI. To launch Apple Hardware Test (AHT) from the Mac OS X Install disc, you must hold down the “D” key during boot.

Unlike the MacBook Pro (17-inch), the MacBook Pro (17-inch Core 2 Duo) now utilizes JST wire bundle connectors that disengage by lifting up and pulling the connector out of its mating part on the logic board. To reconnect, just snap the connector back in, making sure it is seated securely. The fans, thermal sensors, and backup battery all use this connector.

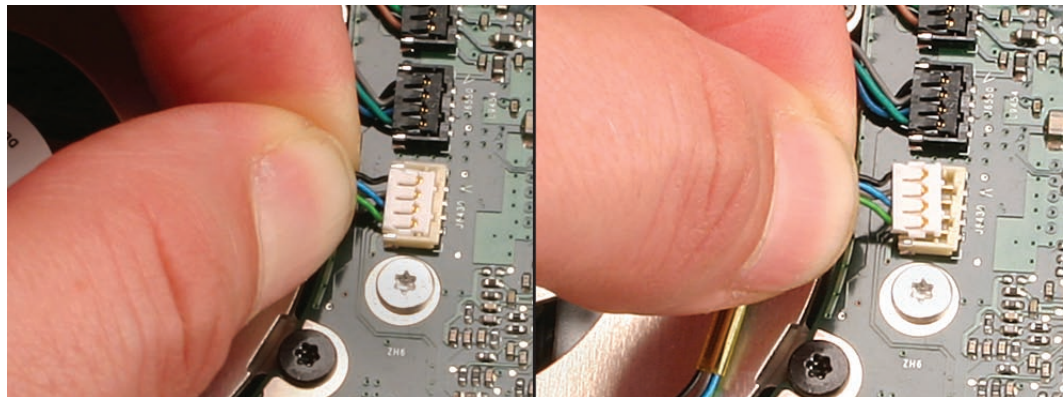

### Main Memory

The memory connector is a stacked memory design. The MacBook Pro (17-inch) supports up to 2GB of RAM, and the MacBook Pro (17-inch Core 2 Duo) supports up to 3GB. However, note that in the latter, while you will have a perfectly bootable system with two (2) 2GB RAM modules—



---

and even About This Mac will report 4GB of installed memory—the system will only be able to address 3GB of that installed RAM.

See [MacBook Pro \(Core 2 Duo\): Memory Specifications](#) for more information.

## Main Battery

Both MacBook Pro 17-inch models use battery packs built with the same lithium polymer battery technology used in our iPod product line, though the basic chemistry is no different than previous lithium ion cells. An unchanged battery controller keeps the [battery calibration procedure](#) the same as it has been since the PowerBook G4 line.

## Power Adapter

All MacBook Pro models use an Apple 85-Watt Portable Power Adapter with the revolutionary MagSafe power connector. It is not compatible with any previous notebook computer.

The MagSafe connector consists of a magnet inside the computer and an attraction plate in the DC plug on the power adapter. Since the power port has a magnet built in, whenever you service the system it is recommended to put a piece of tape over the connector to avoid materials such as screws and washers from being inadvertently drawn into it.



The DC plug consists of five pins. Each pin is spring loaded. The center pin is a sense pin (2). This center pin must make contact with the computer before power is applied. Power is carried on the remaining four pins (4). The outer pins are positive terminals, the inner pair are the return paths.

Since there is no up side to the DC plug, it can go either way. To support this design, the power LED (1) is on both sides of the connector. As always, the LED will glow amber when charging the battery, and green when supplying power to the system but not charging the battery.

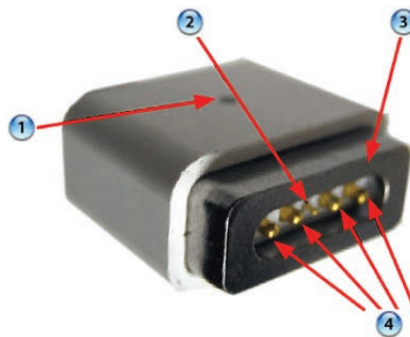

---

## Top Case

For both MacBook Pro 17-inch models, the sleep magnet is located on the side of the display bezel, and the sleep sensor is located to the right side of the top case just around the bottom of the perforated speaker openings.

## Keyboard

Both 17-inch MacBook Pro keyboards utilize flex cables that are incompatible with previous PowerBook G4 keyboards. Also, this flex cable difference renders the 15-inch MacBook Pro keyboard incompatible with either 17-inch MacBook Pro model.

The MacBook Pro (17-inch Core 2 Duo) keyboard backlighting has been improved over the MacBook Pro (17-inch) model. In addition, the programming of the caps lock key was changed to fix a developer keyboard mapping issue, and thus cannot be used in the previous MacBook Pro (17-inch) or the caps lock key will not be recognized.

## Mass Storage (hard drive and optical drive)

The hard drive interface for all MacBook Pros is Serial ATA (SATA); thus, previous PowerBook hard drives will not work in this system.

The optical drive in both 17-inch MacBook Pro models is basically the same mechanism used in the PowerBook G4 (17-inch Double-Layer SD), but it has updated firmware. You should not interchange the two parts.

## AirPort Extreme

The MacBook Pro (17-inch) uses the same AirPort Extreme card as the 15-inch MacBook Pro and does not support Bluetooth. It is the same form factor used in the iMac (Early 2006). However, there are two version of these cards. We have structured service parts to keep them separate.

The MacBook Pro (17-inch Core 2 Duo) utilizes a newer AirPort Extreme card with a three-wire antenna solution. The length of each wire and its color will help distinguish which wires go to which terminals on the card (black = longest/left, gray = medium/middle, blue = shortest/right).



The AirPort antenna for both 17-inch MacBook Pro models is located in the clutch barrel underneath the gray plastic window.

---

## Bluetooth

Each 17-inch MacBook Pro model has a Bluetooth module with its own separate antenna, both located in a plastic bracket to the left side of the hard drive.

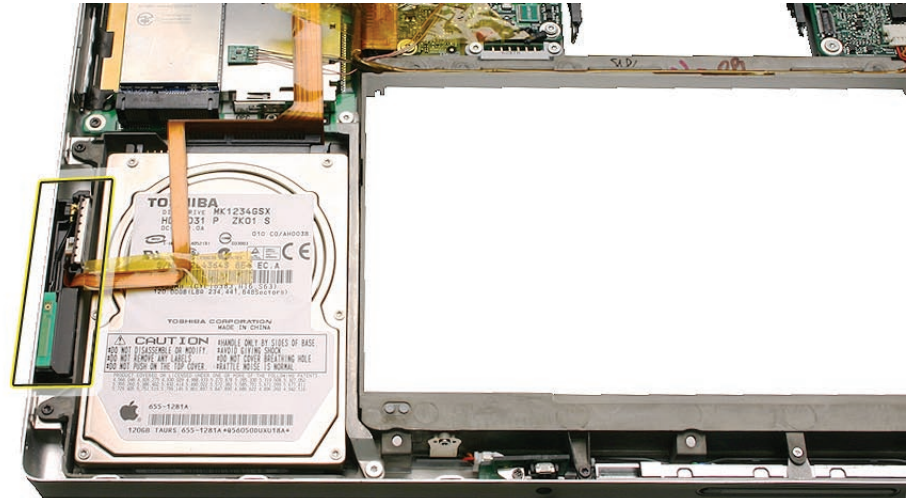

However, unlike the MacBook Pro (17-inch), the Bluetooth bracket in the MacBook Pro (17-inch Core 2 Duo) comes wrapped in a foil EMI shield, which can be ordered as a separate part if it is rendered unusable for reuse during repair.

## Backup Battery

The backup battery is not rechargeable. It only provides power to the real time clock and does not support system memory.

Without a power adapter connected, when you swap the finished goods battery in a running system, it must be done from sleep. The system will shutdown when you remove the battery. When you power back up, it will boot up from SafeSleep, a hibernation state.

## ExpressCard

ExpressCard has replaced the PCMCIA card cage in the PowerBook G4. The ExpressCard standard supports two sizes cards, 34mm and 54mm width. MacBook Pro supports the 34mm standard.

Unlike the previous PCMCIA design, there is no eject button. The card itself is used to engage and disengaged itself from the card cage. In some designs like Ethernet ExpressCard, the card sticks out beyond the card cage. It is easy to push on the card to release it. Other cards will be flush with the MacBook Pro enclosure and will take a little more care to pop out.

## Speakers

Both 17-inch MacBook Pro models sport four speakers with two separate speaker modules (left and right), each with two speakers each. Each module has expanded housing to produce greater

---

sound energy than the PowerBook G4. Since the system can output a lot of sound, it is very important to **make sure screws are properly tightened down**. As a mobile product, a loose screw can eventually work itself free, and using the speakers at elevated volumes can also work toward loosening a screw that is not properly installed.

In addition, each speaker is driven by its own amplifier, as is the headphone port. As such, troubleshooting between speaker and left I/O board failures will require some part swapping to pinpoint the problem module (see the [Sound](#) heading in Troubleshooting section).

### Infrared Board and the Apple Remote

The infrared port is placed on the front of the unit just to the left of the display latch button. This port is used in conjunction with the Apple Remote provided with each unit. It can be used to control Front Row software that manages your music, photos and videos. The remote can also be used to control other applications as well.



### iSight Camera

An iSight Camera is built-in into the display bezel of both 17-inch MacBook Pro models, allowing a user to capture video and take still photos. A green LED to the right of the camera glows when the camera is on.

Unlike the standalone iSight camera, the microphone is not integrated with the camera. It is located by the left speaker.

### iSight Camera Status LED

The opening for the green status LED to the right of the camera on the MacBook Pro (17-inch) no longer appears in the display bezel. When the LED lights up on the MacBook Pro (17-inch Core 2 Duo), it is now visible through a clever pattern of micro perforations.



---

## Identifying the MacBook Pro (17-inch & 17-inch Core 2 Duo)

Below are views of the MacBook Pro (17-inch) and (17-inch Core 2 Duo), with identifying features. The difference in the iSight LED between the two models is covered in the previous section.

**Left side:** MagSafe™ magnetic power connector with two USB ports and ExpressCard.



**Right side:** Security lock slot, FireWire 800 port, no S-video.



**Front:** Infrared sensor window.



**Display bezel:** MacBook Pro.



**MacBook Pro (17-inch) Rear:** Grey antenna window in the clutch cover.



**MacBook Pro (17-inch Core 2 Duo) Rear:** Wider venting than previous MacBook Pro.



---

## Serial Number and Ethernet ID

The Serial Number and Ethernet ID are located in the battery bay.

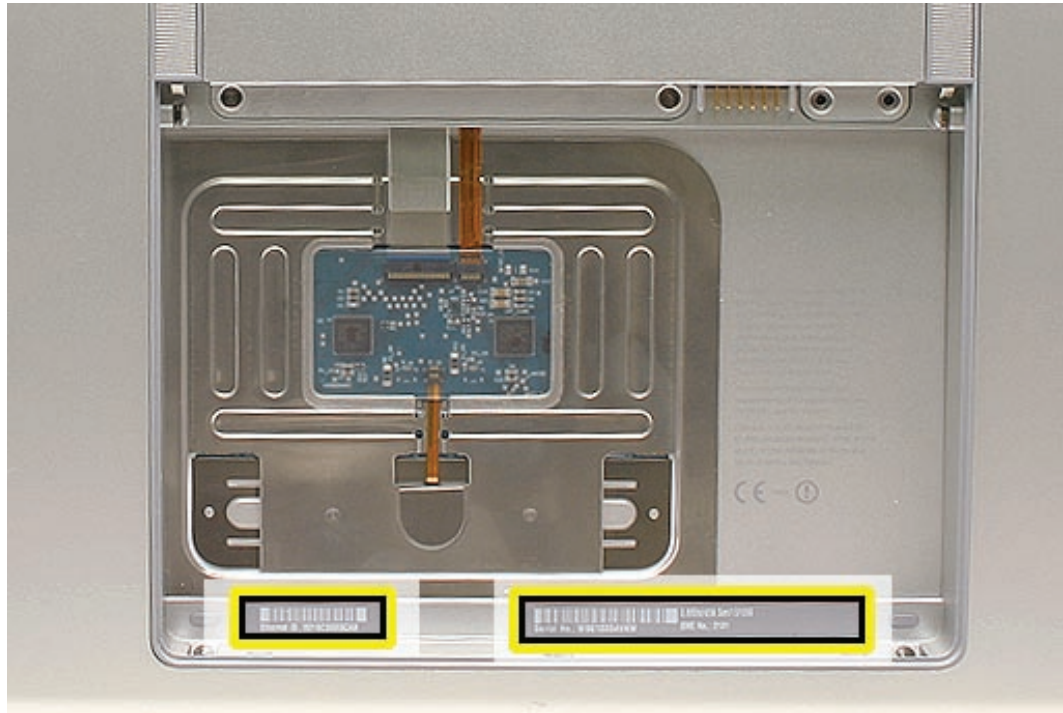

## Tools

This procedure requires the following tools:

- Clean non-marring work surface
- ESD wrist strap and mat
- Multi-compartment screw tray (such as a plastic ice cube tray)
- #0 Phillips screwdriver (magnetized)
- Torx T6 screwdriver (magnetized)
- Black stick (nylon probe 922-5065) (or other non-conductive nylon or plastic flat-blade tool)
- Razor knife
- Needle-point metal probe
- Needlenose pliers
- Kapton tape (922-1731 (0.5-inch x 12-yard roll))
- Thermal grease (922-7144, Pkg. of 3 syringes)
- Gasket kit (076-1206)
- Isopropyl alcohol cleaning wipes
- Fine-point felt-tip permanent marker
- Apple Pro keyboard and mouse (for troubleshooting)

---

## **Electrostatic Discharge (ESD)**

Use a properly grounded ESD wrist strap and mat when working on the inside of the computer.

## **Service Manual Note**

In this manual, graphics or photos are intended to help illustrate procedures or information only, and may show different levels of disassembly, board colors, configurations, or computer models, than your computer.

## **Kapton® Tape Note**

Kapton tape is used to secure cables and connectors where necessary.

During disassembly, note any Kapton tape use and locations—reapply in the same manner. Do not over apply or build up tape on top of old tape; space tolerances are tight and build up or extraneous use of tape may cause pressure on other components.

## **Cable Routing Note**

The MacBook Pro matches the same one-inch enclosure height established with the PowerBook G4 17-inch series of systems. More so than ever, the placement of parts and wiring is critical.

During disassembly, note cable routing. Reassemble in the same manner. Verify that cables do not route over components when they should route into lower positions or channels. Verify that the cables are not strained or applying pressure onto other components.

## **Screw Measurement and Callout Note**

All screw measurements given are the specified full length. Actual measured lengths may vary. Screw part numbers were assigned using a pre-production unit and are subject to change.

## **Temperature Concerns**

The customer may perceive this system to run hotter than previous models. However, the normal operating temperature is well within national and international safety standards. Still, customers may be concerned about the heat generated by their machine. To prevent an unnecessary repair, you can compare a customer's computer to a running model, if available, at your repair site.

For more information on temperature concerns and customer perception, refer to Knowledge Base article 30612: [Apple Notebooks: Operating Temperature](#).

---

Apple Service Source



Take Apart  
MacBook Pro  
(17-inch & 17-inch Core 2 Duo)





# Foot



## Tools

This procedure requires the following tools:

- Foot kit
- Tweezers or needlenose pliers
- Soft cloth

## Preliminary Step

Before you begin, check the foot location that needs replacement and verify that the case plug is attached. Also verify that the case plug, and the case foot in the kit, match the pictures below.

Plug Area on Bottom Case	Matching Foot	Action
Missing case plug 	Not available for replacement	Replace the bottom case, or send to Apple Repair Center.
Case plug (either one) 	Case foot 	Continue with the procedure, matching the foot to either plug on the bottom case.

---

## Procedure

**Warning:** The glue used in this procedure can bond instantly to skin. Do not touch the glue. In the event of contact, review the safety instructions at the end of this document. For additional information, refer to the glue manufacturer:

Elmer's Products, Inc.  
Columbus, OH. 43215-3799  
[www.krazyglue.com](http://www.krazyglue.com)

1. Place the computer upside down on a clean, lint-free cloth or other nonabrasive surface.
2. Select a foot from the kit. Verify that the case plug and case foot match (refer to the images shown in the table). Do not use a foot that does not match.
3. Make sure the plug area on the bottom case is clean. If any portion of the soft rubber foot remains, remove it so that only the hard plastic plug is visible.

**Important:** When positioning the foot, make sure the indents and bumps of the rubber foot match up and fit into the corresponding indents and bumps in the plug. This ensures a balanced and level fitting.

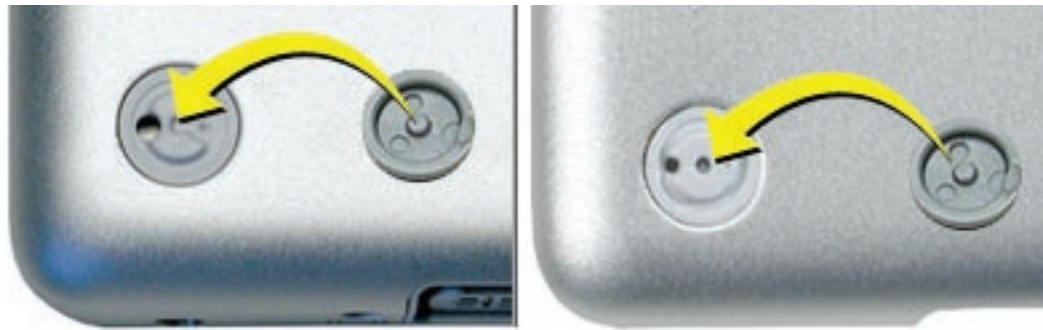

- 
4. **Warning: GLUE IS AN EYE AND SKIN IRRITANT. BONDS SKIN INSTANTLY. Do not touch the glue at any time. Before opening the glue, review the safety instructions below.**

**Important:** The glue tube included in the kit is sealed until first use. Do not break the seal until you are ready to use the glue. To break the seal, hold the tube upright and away from you. Place the hollow nozzle cap on the tube and tighten it all the way down. The tube is then ready to dispense the glue through the nozzle cap.



5. Apply one drop of glue to the plug on the bottom case. Do not spread the glue.
6. Using tweezers or needlenose pliers, carefully position the new foot so its textured surface fits into the inner ring of the plug.
7. Using the end of the tweezers or pliers—not your finger—lightly press and hold the foot in place for 30 seconds.



8. Before turning over the computer, allow the glue to set for at least 15 minutes.
9. Discard the tube of glue.

**SAFETY INSTRUCTIONS:** GLUE IS AN EYE AND SKIN IRRITANT. BONDS SKIN INSTANTLY.

Contains ethyl cyanoacrylate. Avoid contact with skin and eyes. If eye or mouth contact occurs, hold eyelid or mouth open and rinse thoroughly but gently with water only for 15 minutes and GET MEDICAL ATTENTION. Liquid glue will sting eye temporarily. Solidified glue may irritate eye like a grain of sand and should be treated by an eye doctor.

If skin bonding occurs, soak in acetone-based nail polish remover or warm soapy water and carefully peel or roll skin apart (do not pull). Contact through clothing may cause skin burn. If spilled on clothing, flush with cold water. Avoid prolonged breathing of vapors. Use with adequate ventilation. KEEP OUT OF REACH OF CHILDREN.



# Battery

## Tools

This procedure requires the following tools:

- Clean non-marring work surface

## Preliminary Steps

**Warning:** Always shut down the computer before opening it to avoid damaging its internal components or causing injury. After you shut down the computer, the internal components can be very hot. Let the computer cool down before continuing.

## Part Location

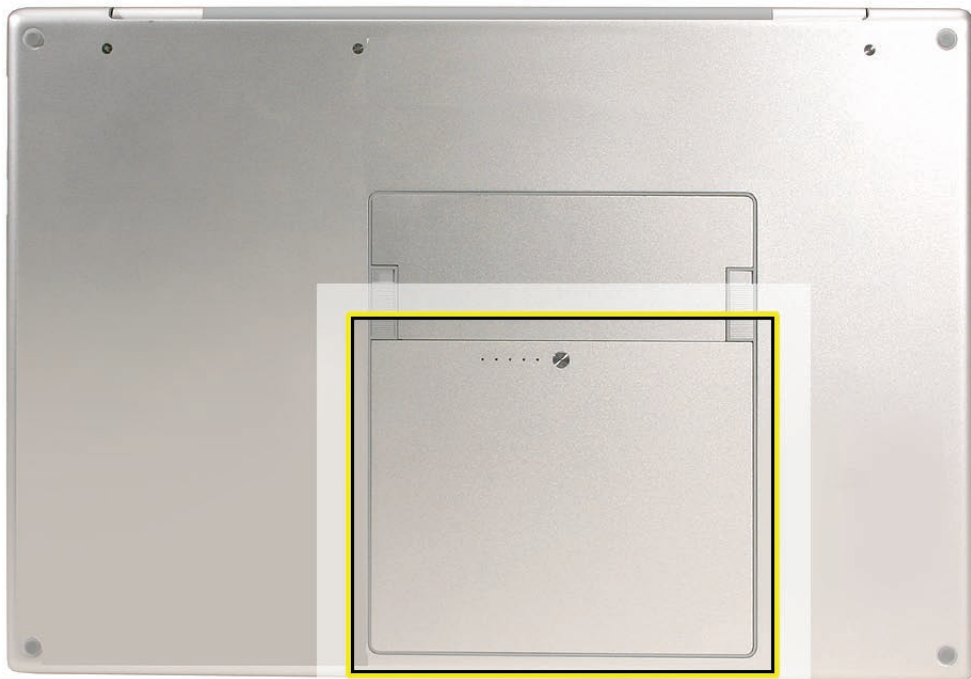

---

## Procedure

**Warning: If the computer has been recently operating, allow it to cool down before performing this procedure.**

1. Shut down the computer.
2. Disconnect the power cord and any other cables connected to the computer.
3. Place the computer upside down.
4. Slide both battery latches away from the battery and lift the battery out of the battery bay.

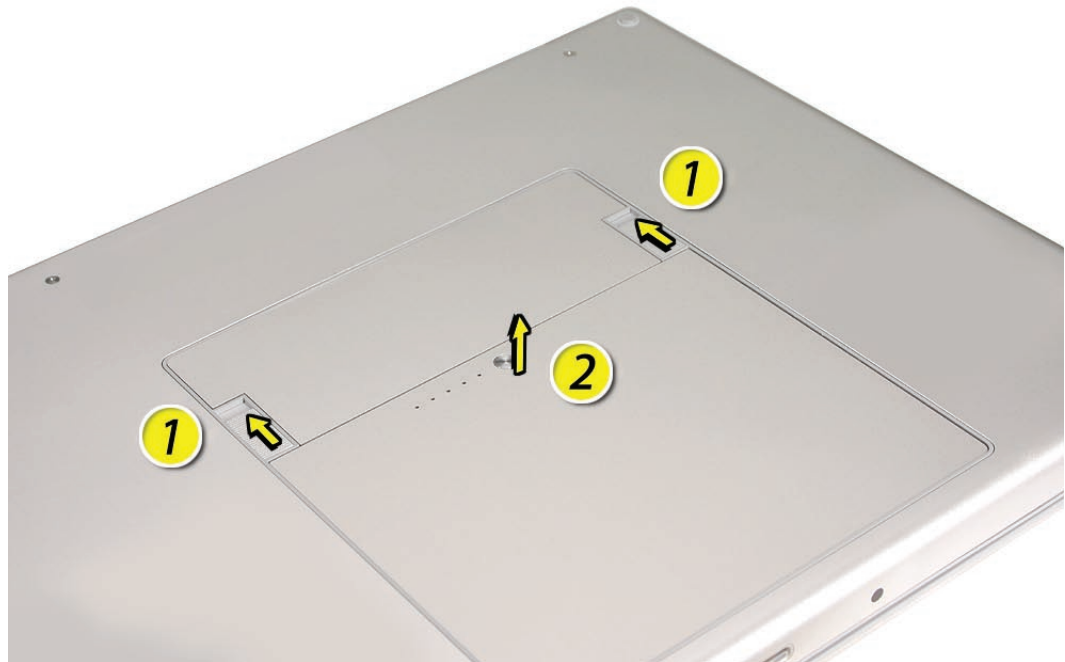



# Memory

## Tools

This procedure requires the following tools:

- #0 Phillips screwdriver (magnetized)
- Clean non-marring work surface
- ESD wrist strap and mat

## Preliminary Steps

Before you begin, remove the following:

- [Battery](#)

## Part Location



## Procedure

**Warning:** If the computer has been recently operating, allow it to cool down before performing this procedure.

1. Place the computer upside down.
2. Remove four screws from the memory door.

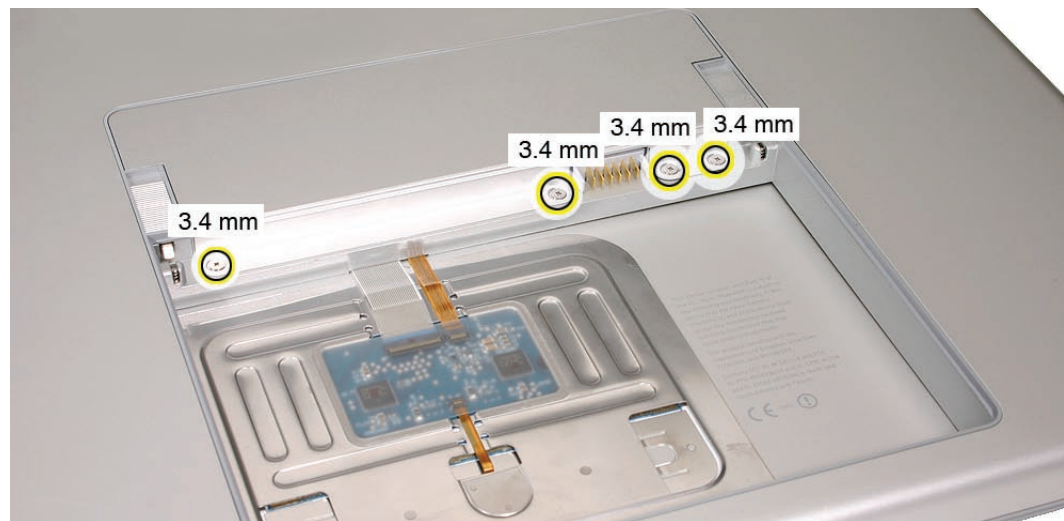

3. Remove the door, as shown.

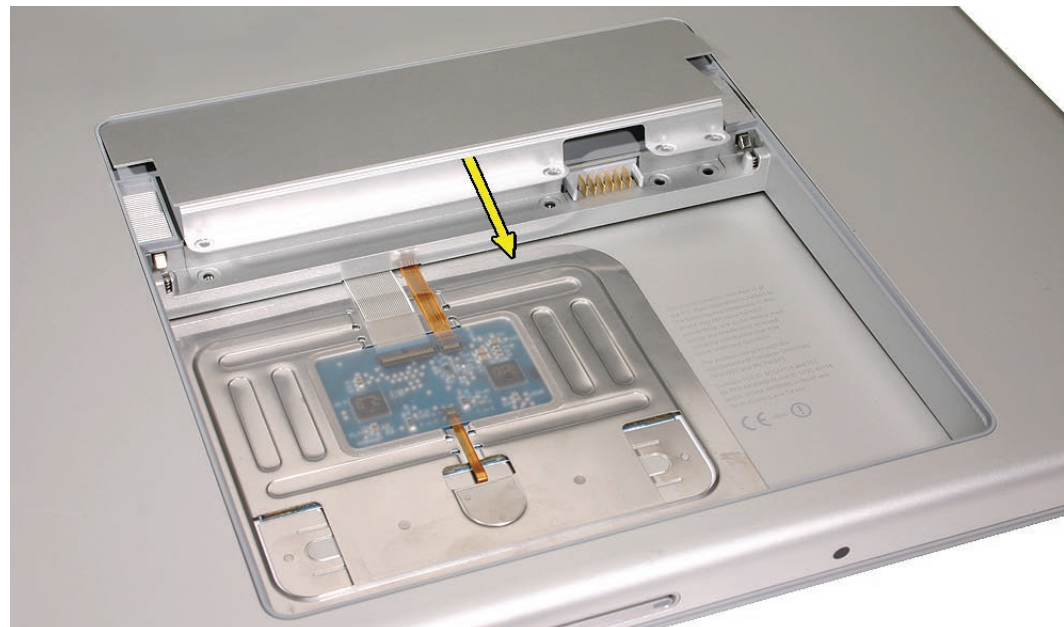

### Notes:

- If only one memory card is installed, the factory installs it in the bottom memory slot.
- Memory must be removed from the top slot before removing from the bottom slot.

4. To remove memory cards, carefully spread the two locking tabs for the slot (top or bottom) away from the card on both sides and allow the card to pop up slightly.



5. Pull the card straight back and out of the memory slot. Handle the memory card by the edges only, taking care not to touch the gold contacts.

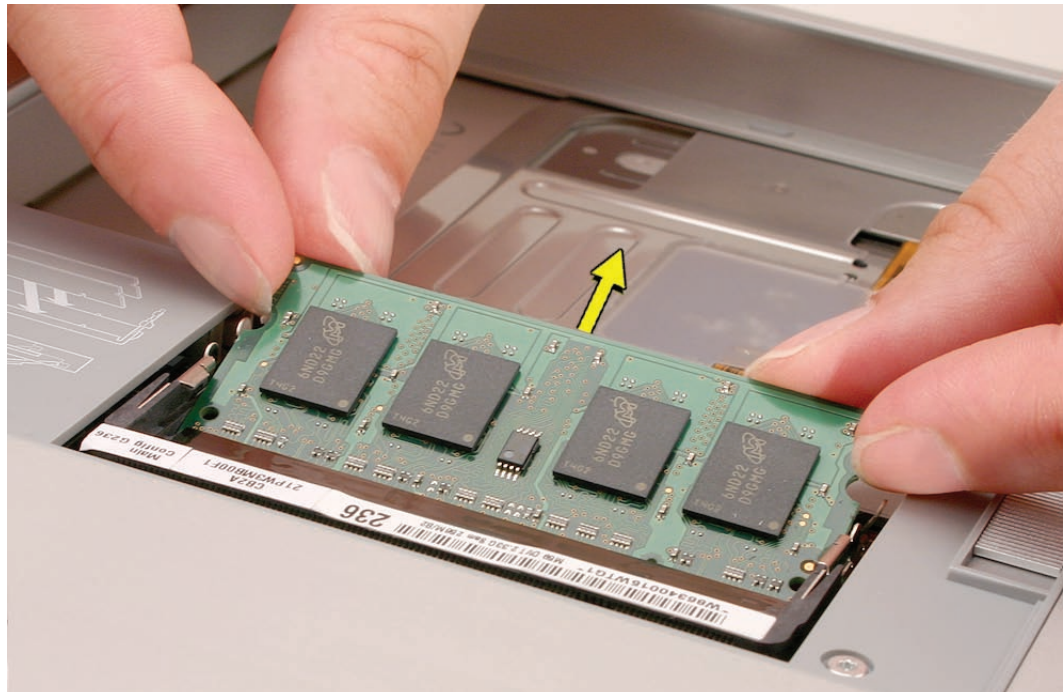



## Replacement Procedure

### Notes:

- DDR memory cards do not fit in this slot, only DDR2 (different notch location).
  - If installing two cards, install into the bottom slot first.
  - Align the notch in the memory card with the tooth in the slot before inserting.
1. To install memory cards, insert them at a 30-degree angle. **Note:** Insert the bottom card behind the locking tabs of the top slot.

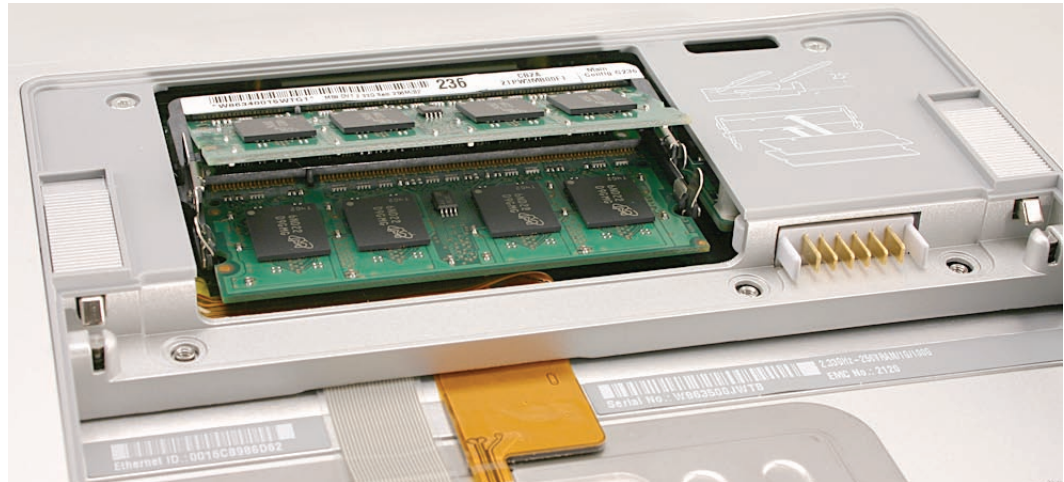

2. Firmly push the card straight into the slot until it is fully and securely seated along its length. **Note:** If the back of the card drops down before it is fully seated, raise it up enough to push it fully into the slot.
3. When the card is fully seated, push the card straight down until the tabs click onto both sides of the card, locking it into place.

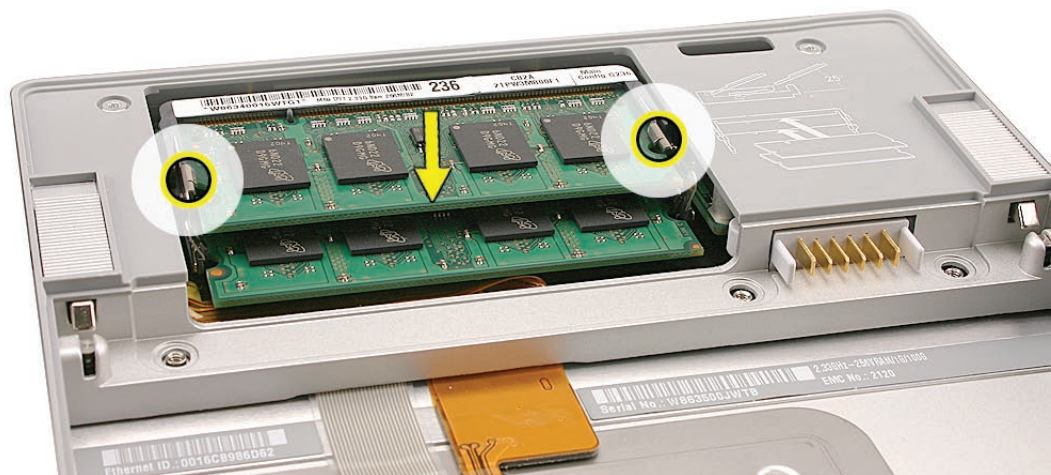

4. Verify that the card is fully seated by pushing firmly with your thumbs.

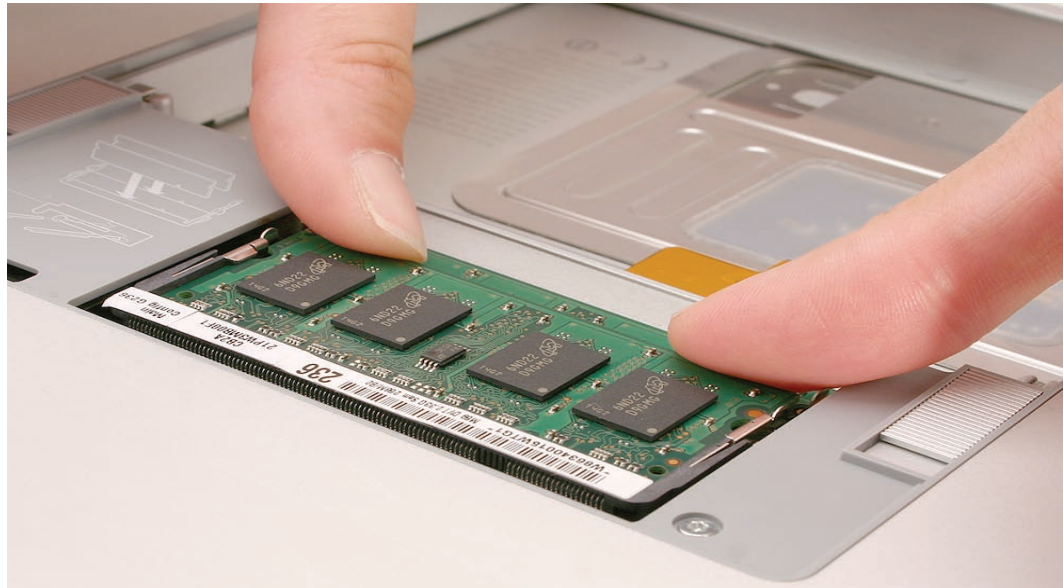

5. Check that the cards are secured by the brackets on both sides.
6. Install the memory door.
7. Replace the battery.
8. **Use Apple System Profiler to verify that the memory is recognized. (Choose the menu bar Apple logo () > About This Mac, click More Info..., select the System Profile tab, open the Memory Overview.)**

**NOTE:** The maximum supported amount of memory in the MacBook Pro (17-inch) is 2GB while the MacBook Pro (17-inch Core 2 Duo) is 3GB.

**Important:** While the MacBook Pro (17-inch Core 2 Duo) will have a perfectly bootable system with two (2) 2GB RAM modules installed—and even About This Mac will report 4GB of installed memory—the system will only be able to address 3GB of that installed RAM.

See [MacBook Pro \(Core 2 Duo\): Memory Specifications](#) for more information.



# Top Case

## Tools

This procedure requires the following tools:

- #0 Phillips screwdriver (magnetized)
- Torx T6 screwdriver (magnetized)
- Black stick (nylon probe 922-5065) or other non-conductive nylon or plastic flat-blade tool
- Multi-compartment screw tray (such as a plastic ice cube tray)

## Preliminary Steps

Before you begin, remove the following:

- [Battery](#)
- [Memory](#)

## Part Location



## Procedure

### Notes:

- This procedure removes the top case and keyboard assembly. The keyboard is removable only after removing the top case.
1. Place the computer upside down.
  2. Remove the nine screws shown.

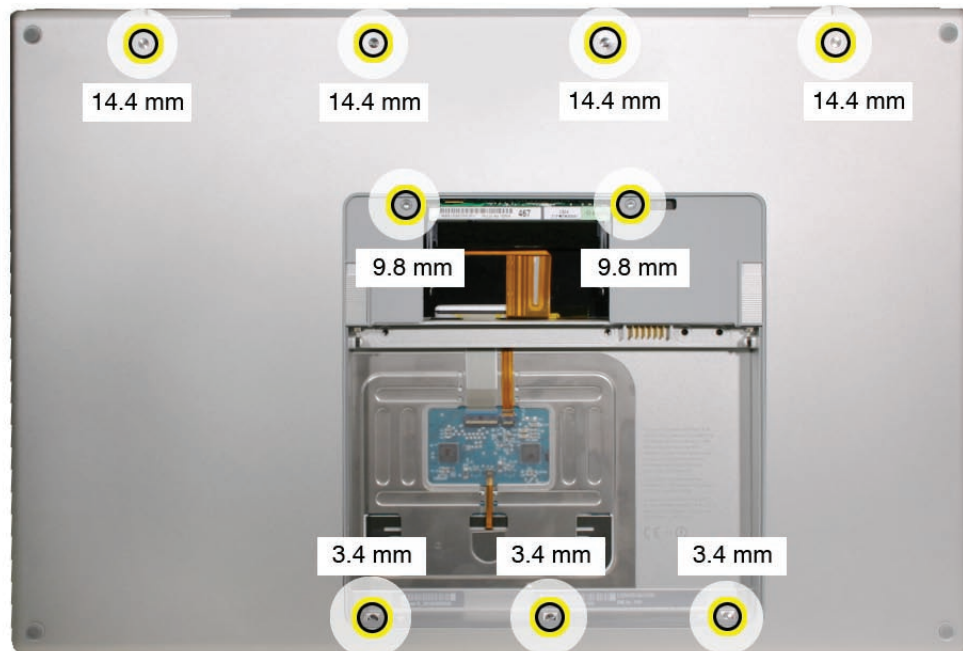

3. Remove the four screws from each side.



4. Remove the two screws from the back edge.



5. Face the computer forward and open the display slightly past 90-degrees.
6. Use a black stick to loosen the top case along the rear of the left and right sides.

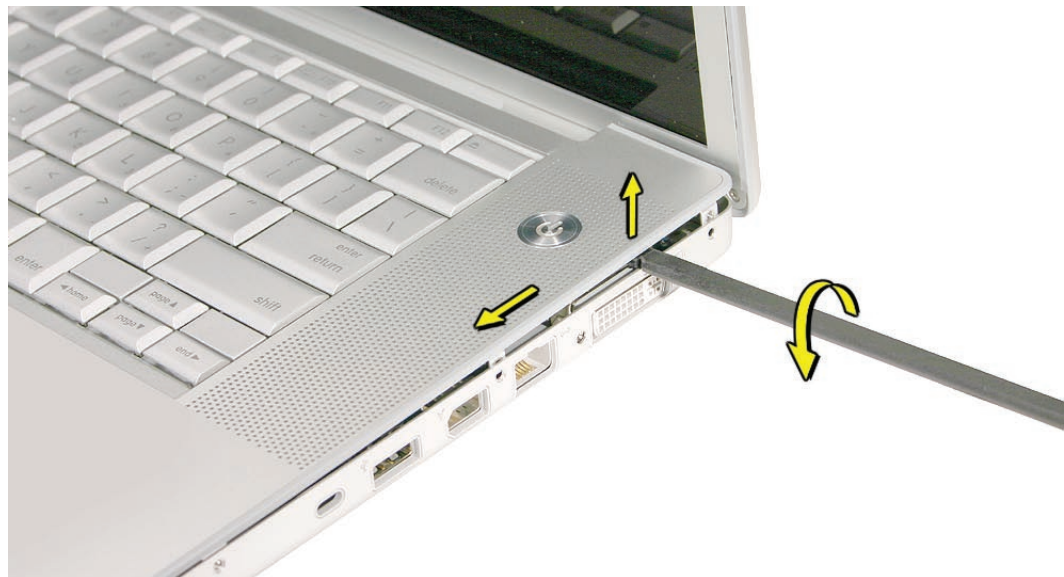

7. Start at the left, along the front, and slowly encourage the snaps and screw tabs (shown in graphic below) to release as you move right.

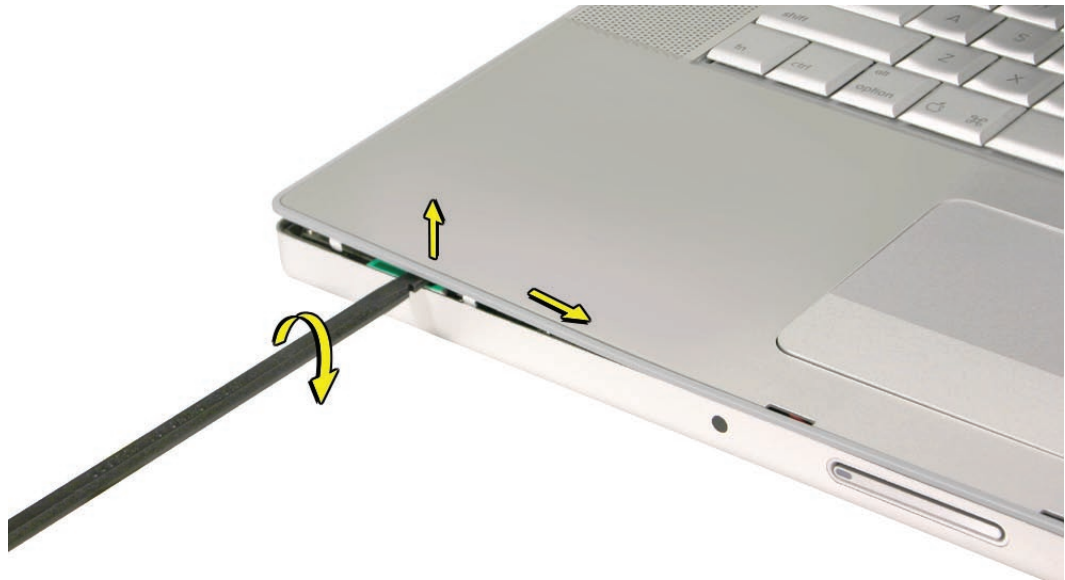

**Important:** Do not lift the case once it is free—it is still connected to the bottom case by the keyboard flex cable.

**Important:** To avoid bending screw tabs along the back edge of the top case, lift the top case slightly so that it does NOT touch the bottom case, then rotate the front of the case up and back until you can disconnect the keyboard flex cable from the logic board.

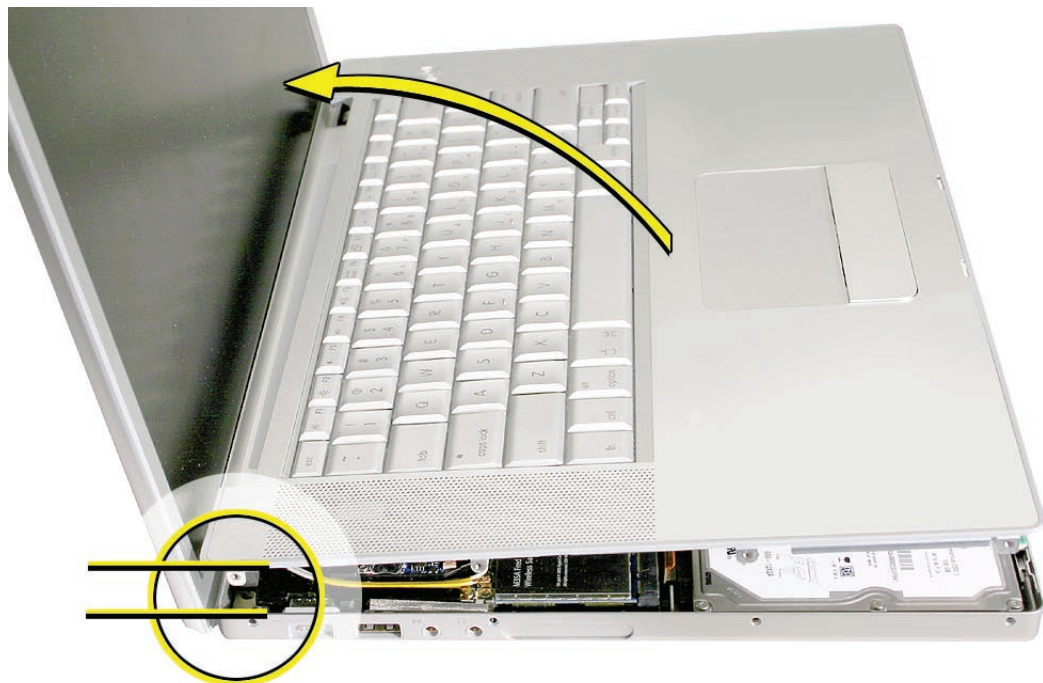

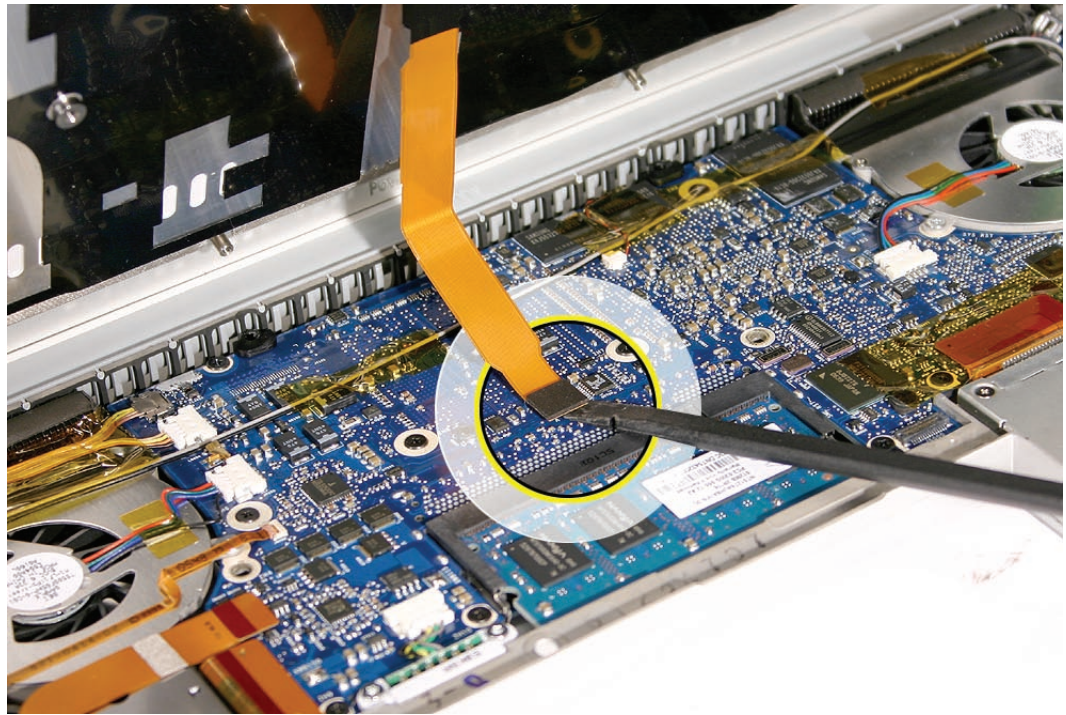

---

## Replacement Procedure

**Note:** If replacing the top case, remove the [Keyboard](#) and transfer to the replacement top case.

1. Visually check to verify that all cables are connected and routed correctly with nothing raised up or incorrectly over a component.
2. Check perimeter wiring and cables around clutches to verify that they will not be caught or pinched by the top case during replacement.
3. On the computer, verify that all cables are secure and lay flat.
4. On the top case, check cable connections and routing.

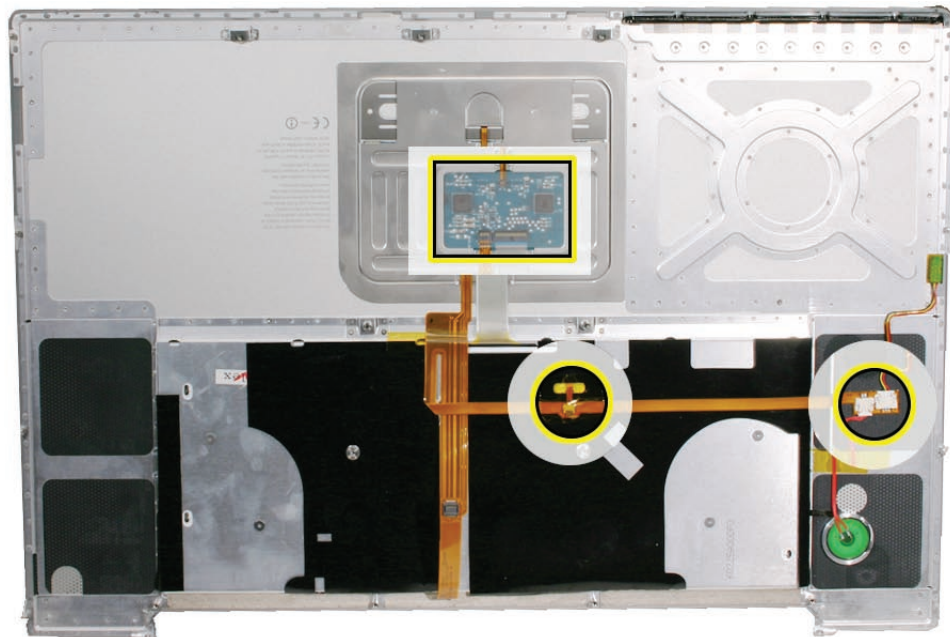



5. Check that the perimeter screw tabs and ribs are not bent.  
**Note:** The metal can quickly fatigue and break off. Be extremely careful to gently straighten tabs, if needed.

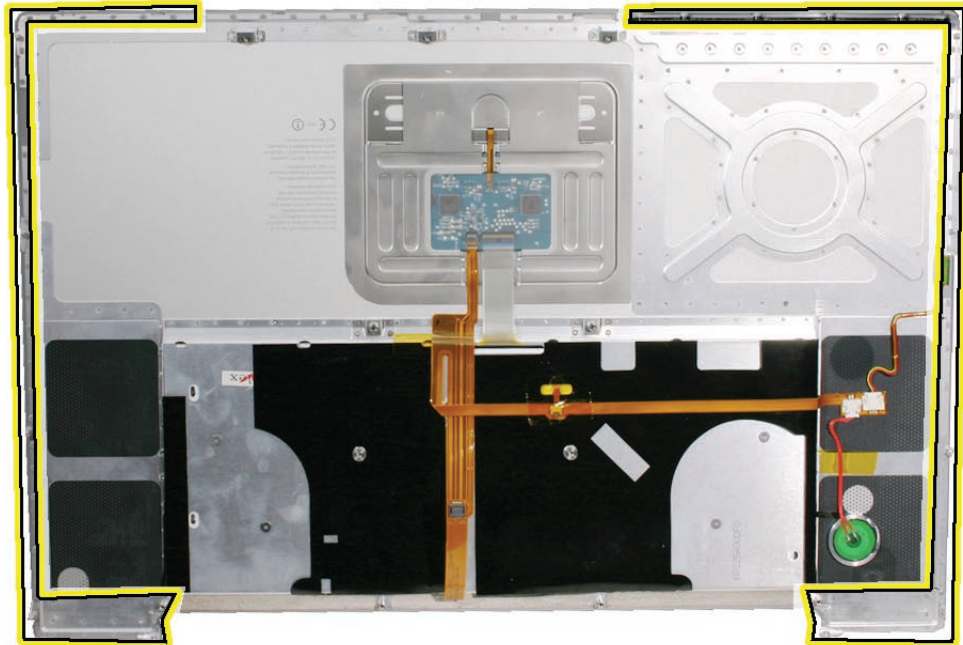

6. Verify that the screw tabs in back are straight and guide them inside the bottom case. Work your way around guiding the screw tabs into the bottom case along both sides.

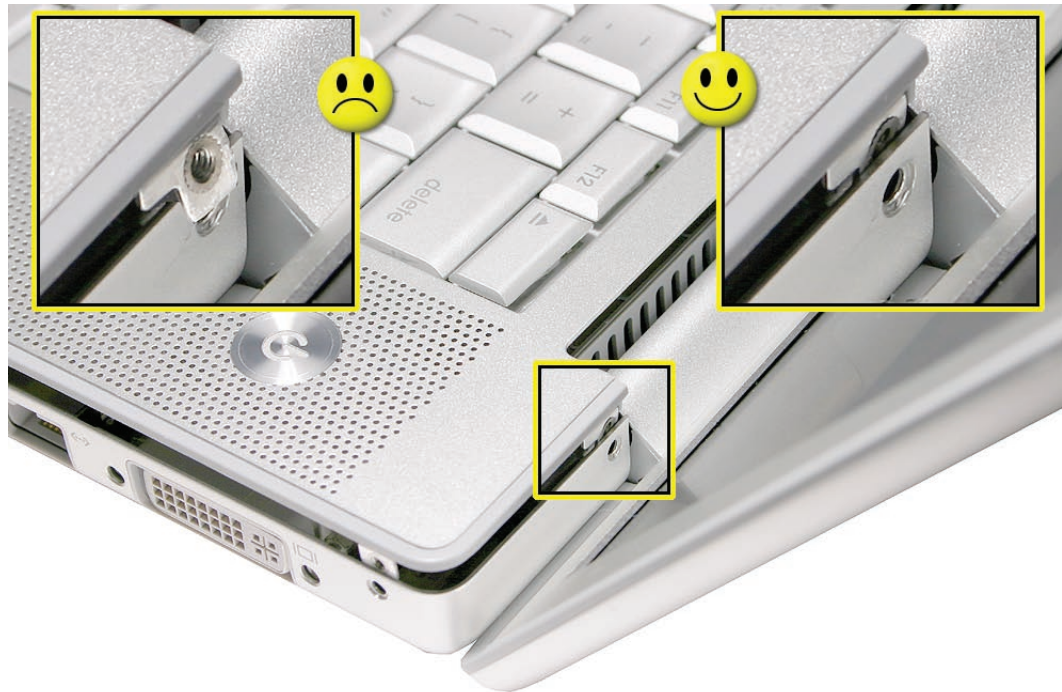

- 
7. If the back screw tabs are bent out, straighten by pressing the edge of the case on a hard flat surface and rolling to vertical.



8. Any screw tabs that are not straight will not fit or accept screws correctly.

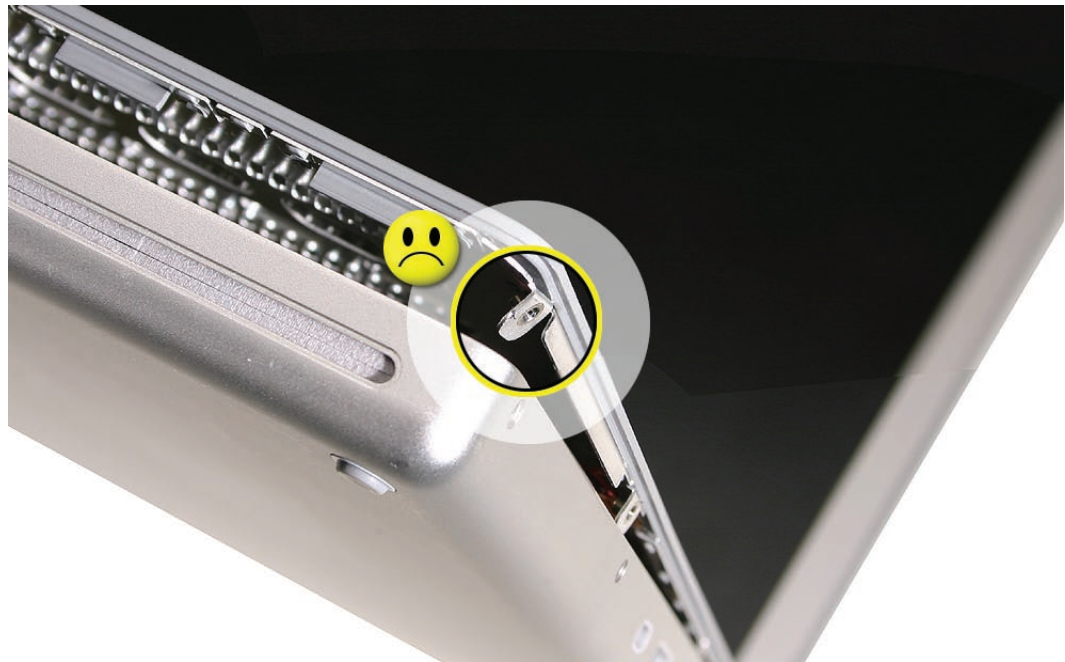

- 
9. Use your finger and a black stick to carefully straighten bent screw tabs.

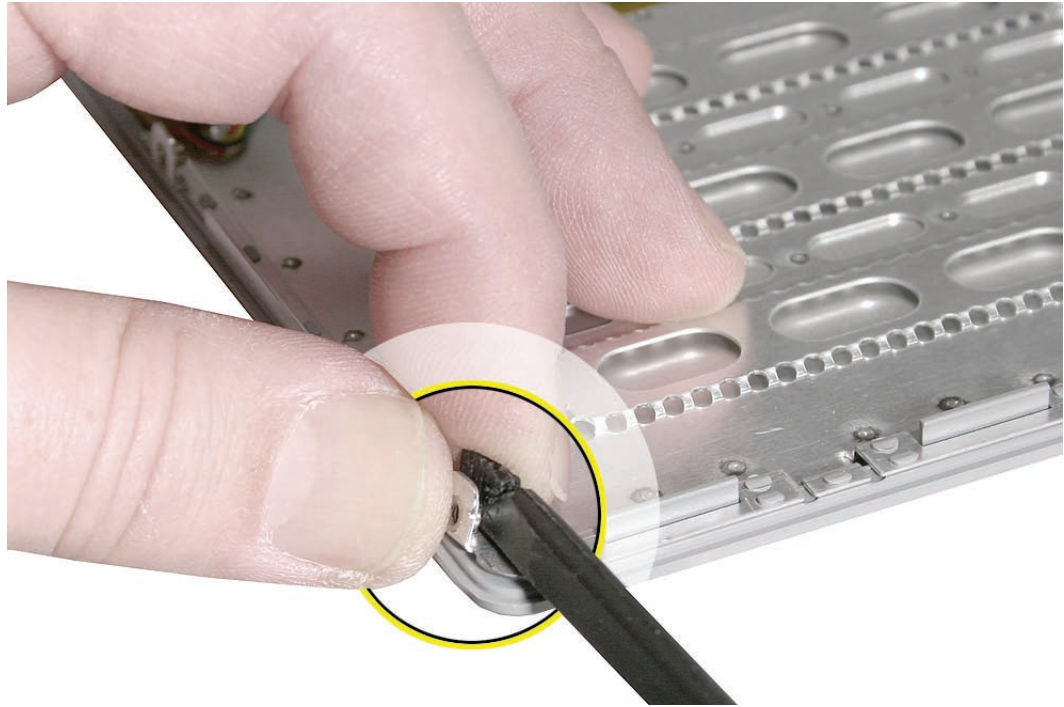

10. Connect the flex cable from the top case to the logic board.
11. Lift the top case off the bottom case slightly and rotate it down (verify that the keyboard cable stays connected and is folding properly) and align the corners.
12. Carefully pull or push tabs slightly, if needed. **Note:** Guarded, controlled pushing with your thumb may be helpful to finesse the tabs into place.
13. The two front screw tabs may need to be guided with a black stick through the battery bay.
14. The top case should lay flat along all sides and top, if not, make sure that cables and components are not interfering.

15. Reinstall the left and right side screws.

**Important:** Do not insert screws into the DVI port screw holes. If they get stuck, it may require removing the logic board to dislodge.



16. Install the bottom screws.

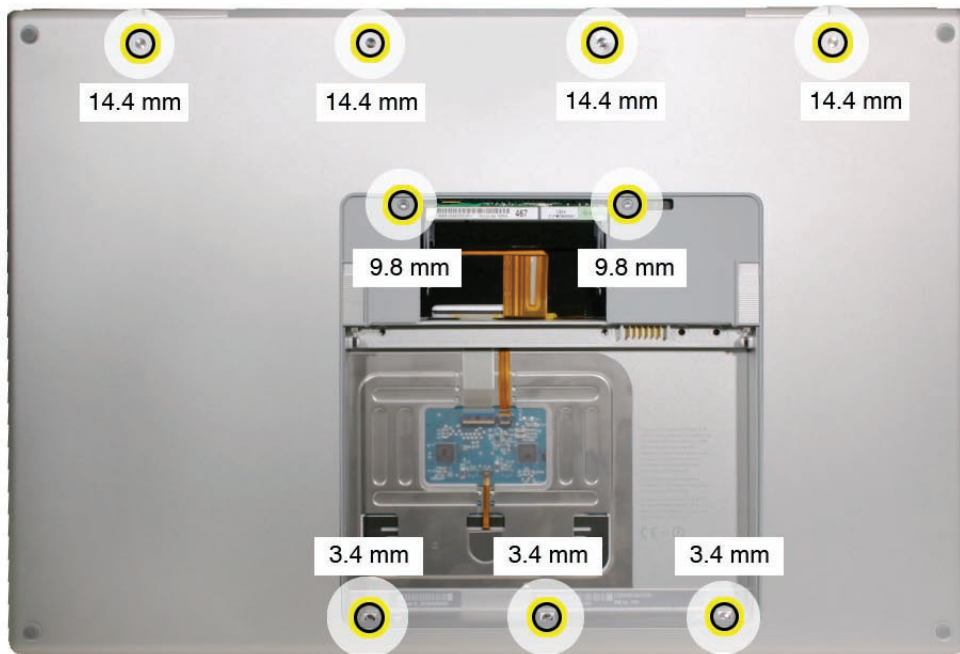

---

17. Install the two screws along the back.



18. Install the memory door and replace the battery.

19. Testing the computer should include:

- Powering on, checking the keyboard and trackpad function.
- Operate the computer in a darkened room to check for keyboard backlight function.



# Keyboard

## Tools

This procedure requires the following tools:

- #0 Phillips screwdriver (magnetized)
- Razor knife
- Needlenose pliers
- Black stick (nylon probe 922-5065) or other non-conductive nylon or plastic flat-blade tool
- Kapton tape (922-1731) (0.5-inch x 12-yard roll)

## Preliminary Steps

Before you begin, remove the following:

- [Battery](#)
- [Top Case](#)

## Part Location



---

## Procedure

### Important Notes:

- All 17-inch MacBook Pro keyboards are not interchangeable with previous PowerBook models. Verify that the correct replacement keyboard is ordered, and/or top case if replacing.
  - In addition, the MacBook Pro (17-inch Core 2 Duo) keyboard is not interchangeable with the MacBook Pro (17-inch). The Caps Lock key was remapped to address a developer escalation.
  - The keyboard comes as a multi-layered assembly, and includes backlighting. Do not disassemble the keyboard assembly. Dust, fingerprints, or misalignment, can cause improper function and damage.
1. On a clean flat surface, turn the top case upside down.
  2. Locate the small flex connector, shown.

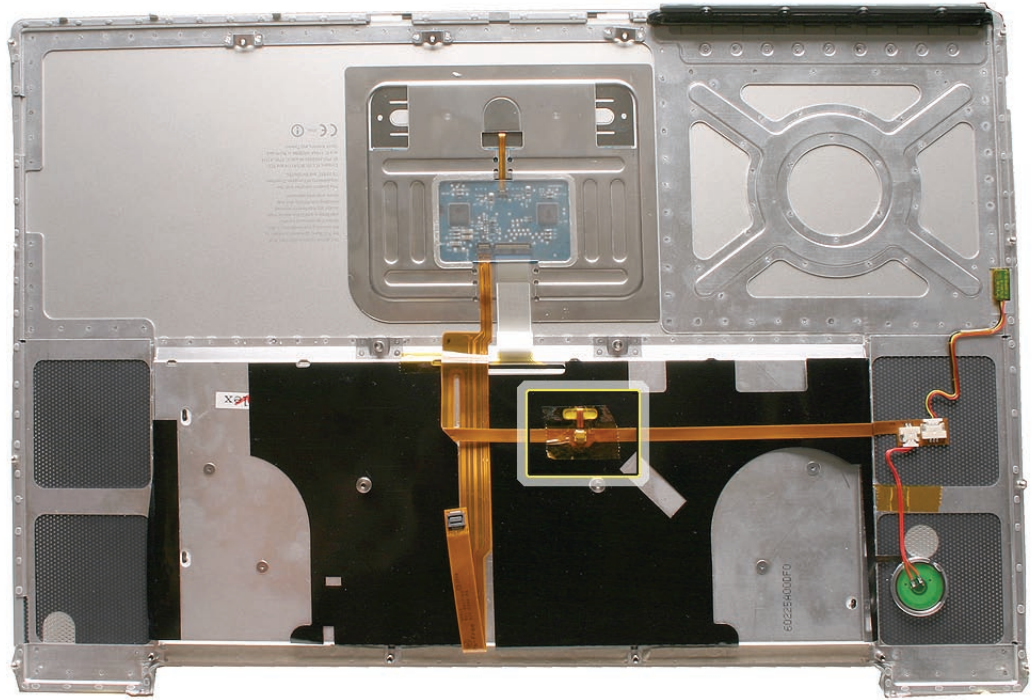

3. Peel off any tape to gain access to the connector.

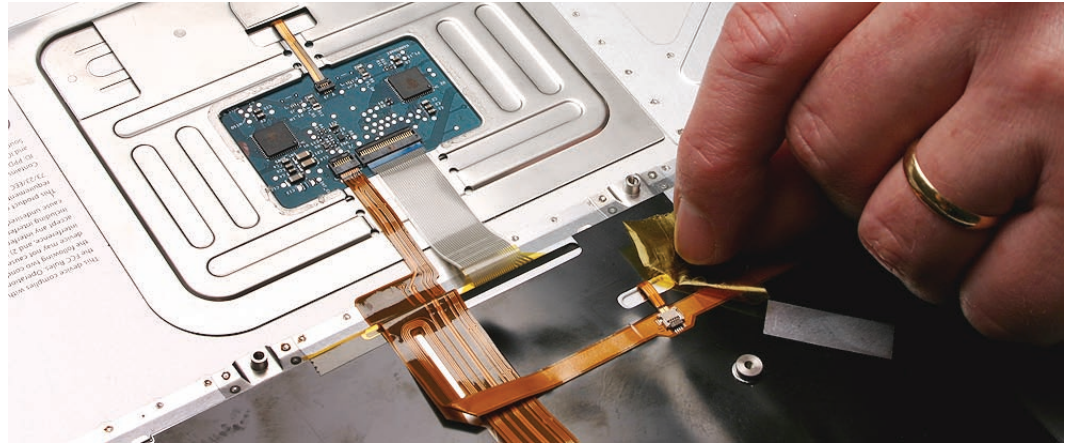

4. Locate the protective cover over flex cable connectors. This will not be removed, but released only half way around to access the large flex cable connector.

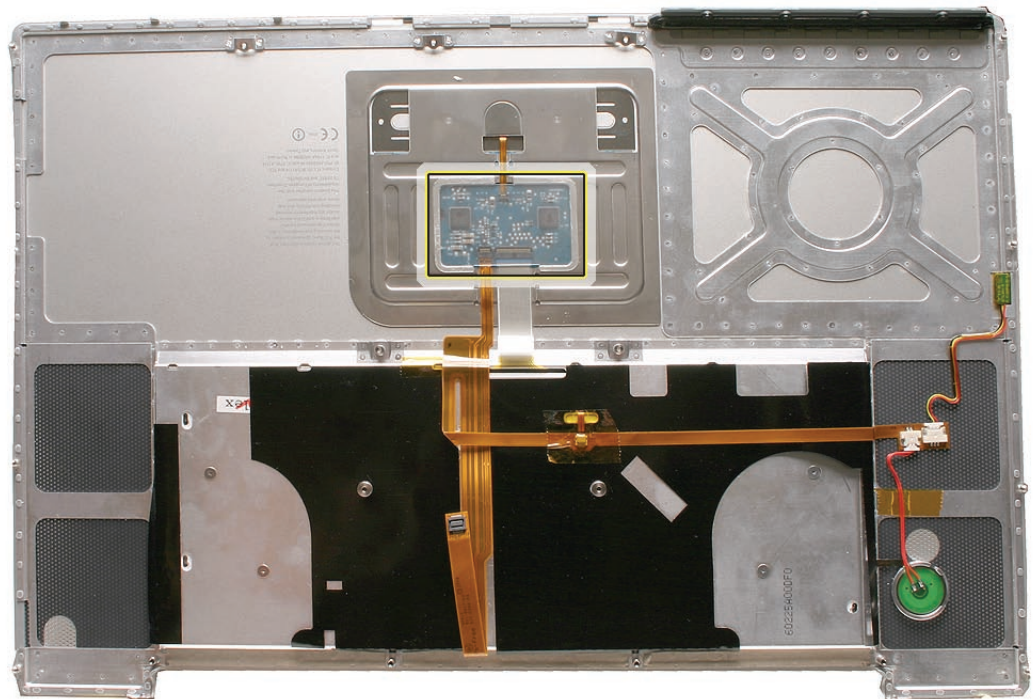



5. Use a razor knife to carefully lift up at the edge just enough to slide in the flat side of a black stick..

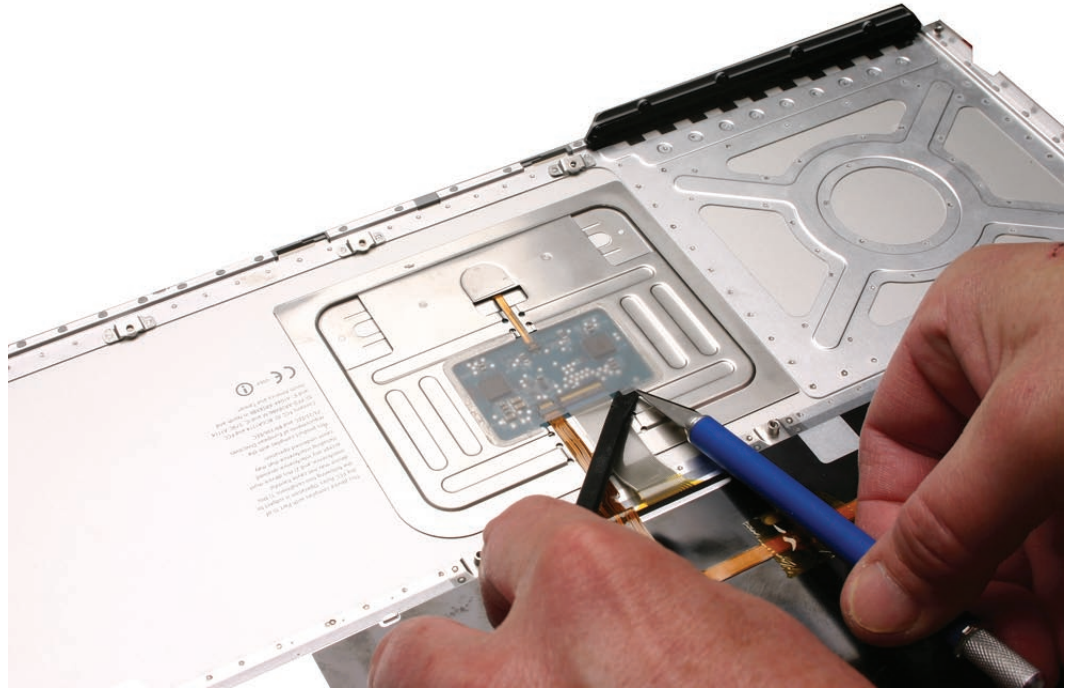

6. To release the adhesive, slide the black stick around the front half perimeter only, as shown.
7. When disconnecting or installing the large flex cable, carefully lift the front of the cover.  
**Important:** Keep the cover and its adhesive clean.

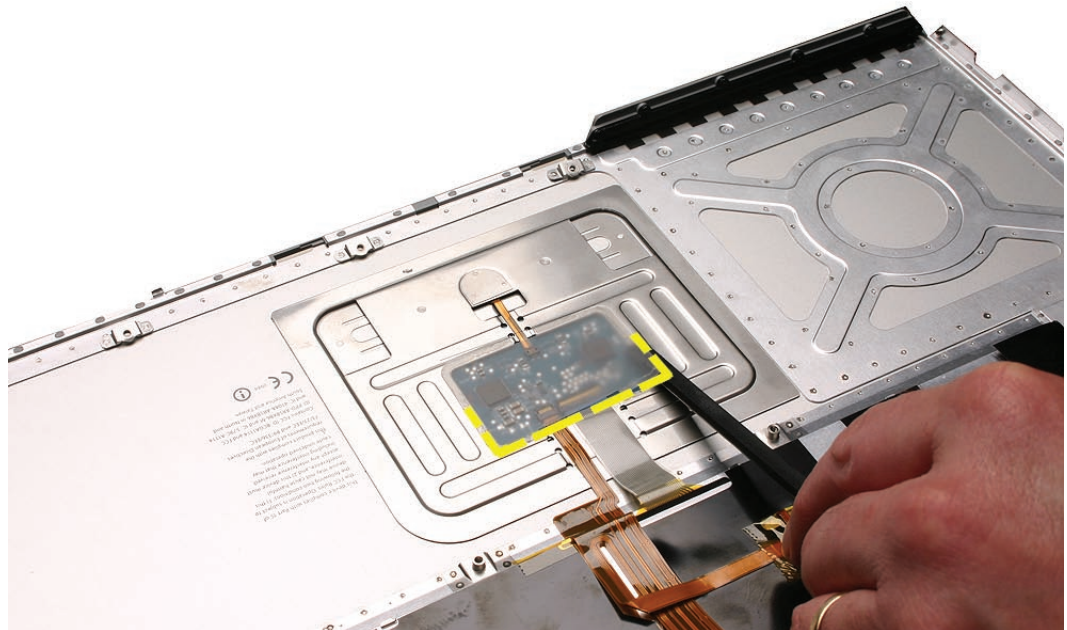

- Carefully disconnect the two connectors, shown below, and slide out their flex cables. The direction that the connector lock bars release is shown in the illustration below. **Important:** The connectors are delicate. If damaged, the top case must be replaced. **Note:** The clear cover is shown removed here, for clarity only.

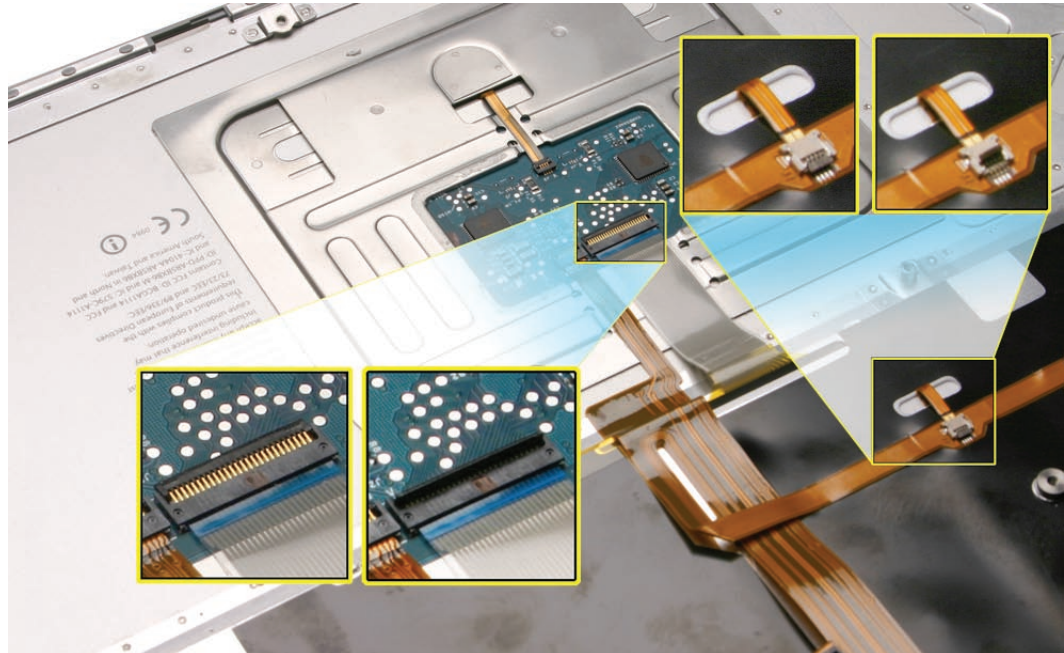

- Release the adhesive under the large flex cable.

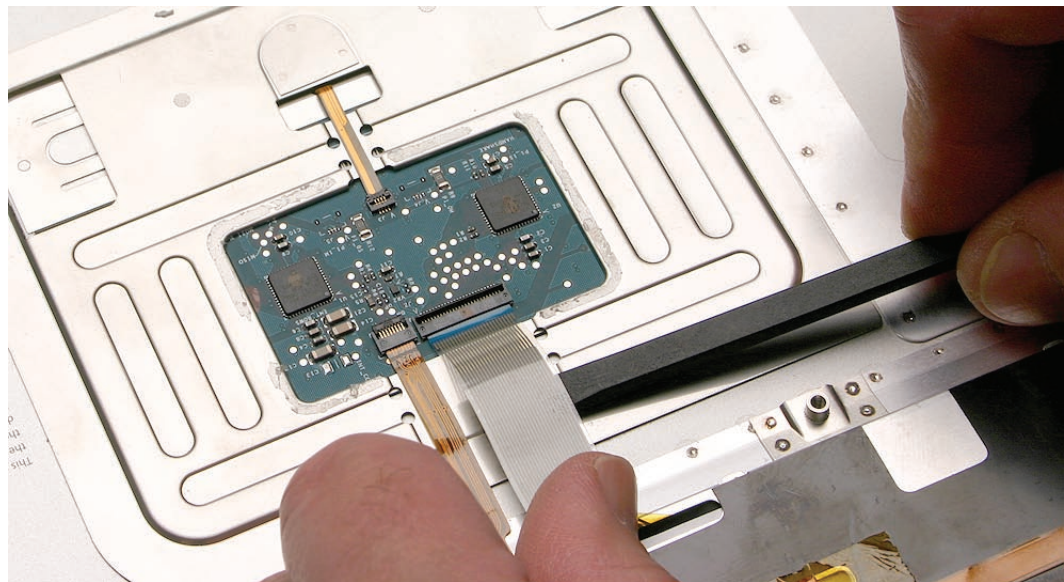

- 
10. Locate the insulator film covering the back of the keyboard well. The film will NOT be removed, but will be peeled back to first access four bend-tabs along the bottom edge, and then to access some keyboard screws.

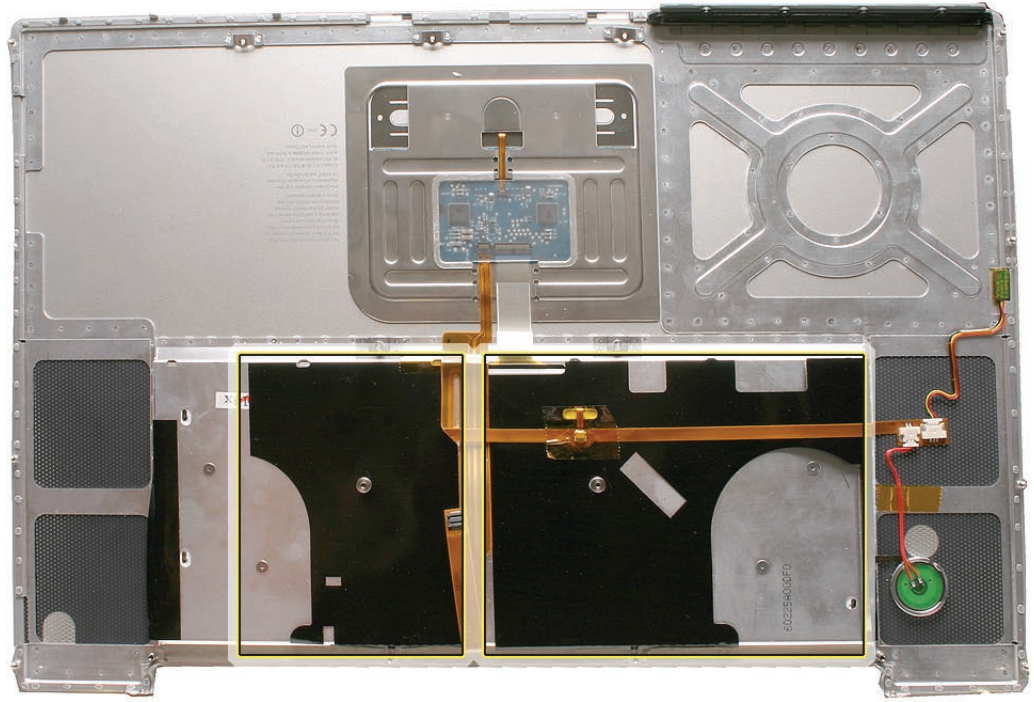

11. Use a razor knife to carefully lift up at the edge just enough to slide in a black stick.  
**Important:** Do NOT cut the film with the knife.

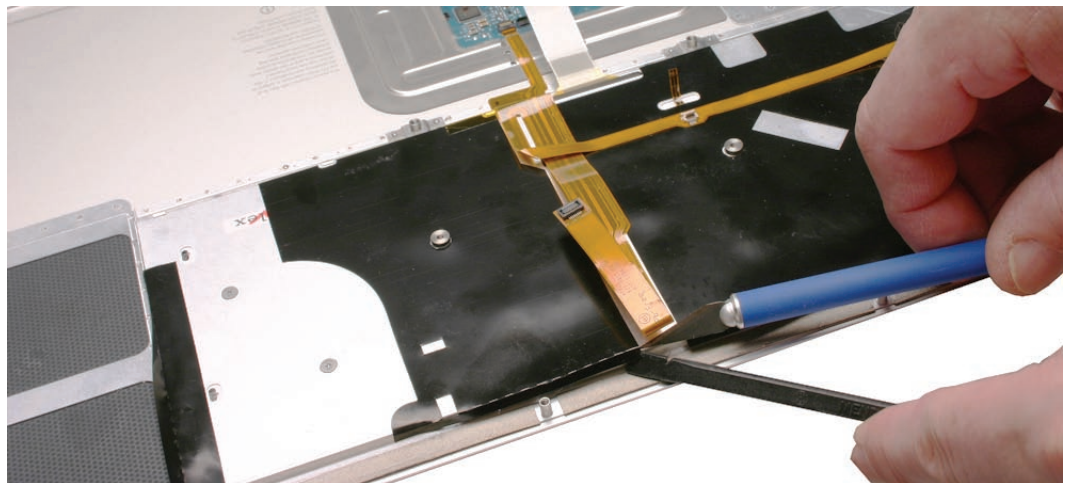

- 
12. Use the black stick to defeat the adhesive at the edge so that the film can be peeled back to access the bend tabs.

**Important:** When peeling, use care at perforations, notches and narrow parts to avoid ripping the film.

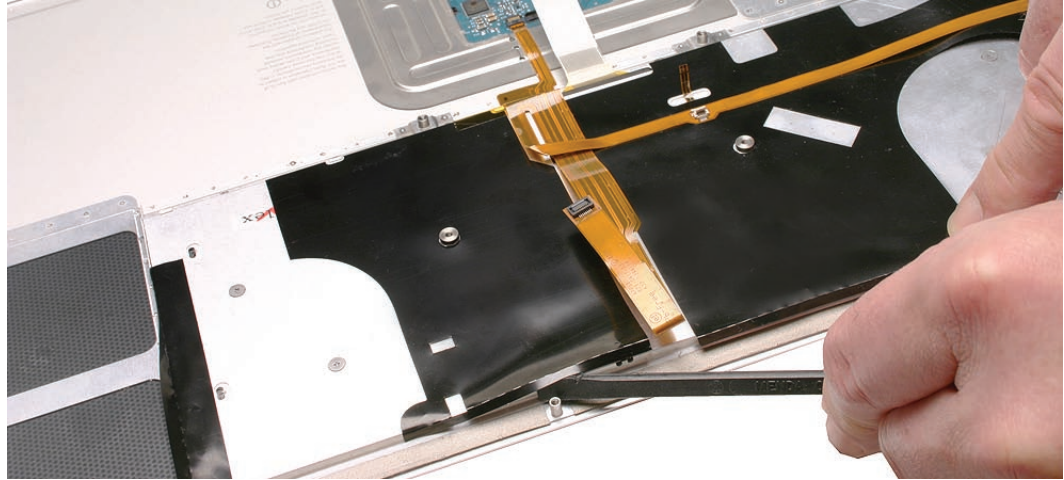

13. Peel back the film to access the bend-tabs. **Note:** Both films are peeled back here to show tab location, but you should work on one side at a time.

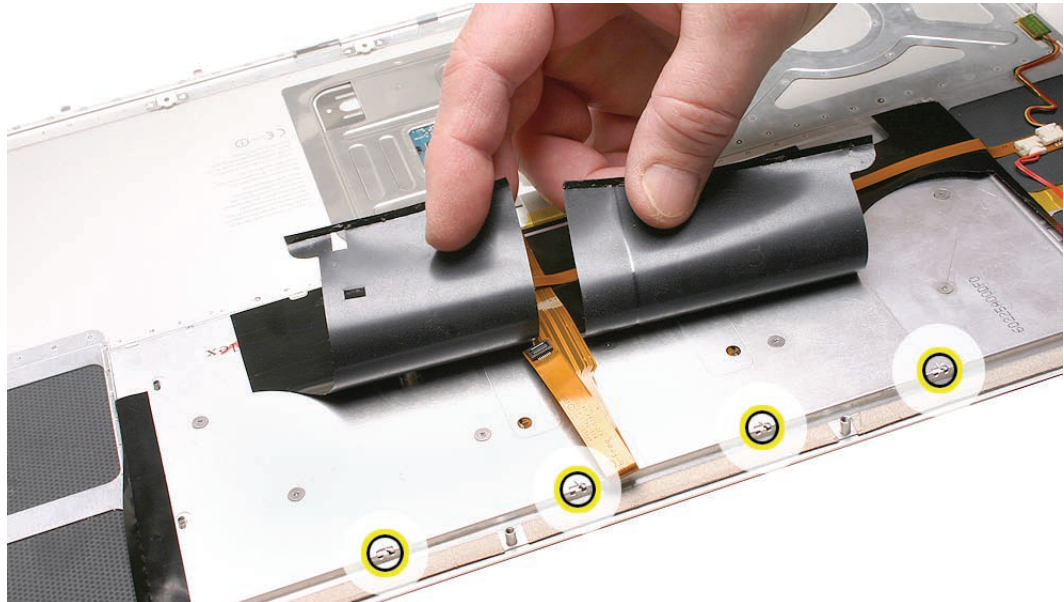

14. Use needlenose pliers to straighten the four bend-tabs, as shown. These tabs lock down and stiffen the top edge of the keyboard. **Important:** The bend-tabs are delicate. Bend them carefully to avoid damage. Avoid over-bending.

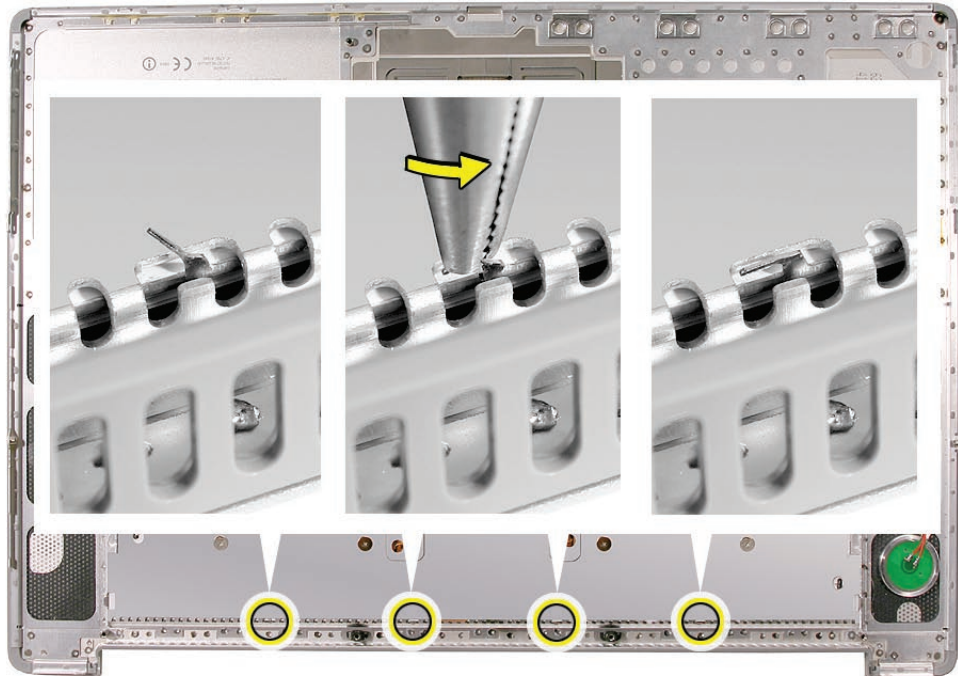

15. Remove the ten keyboard screws. Location shown below.

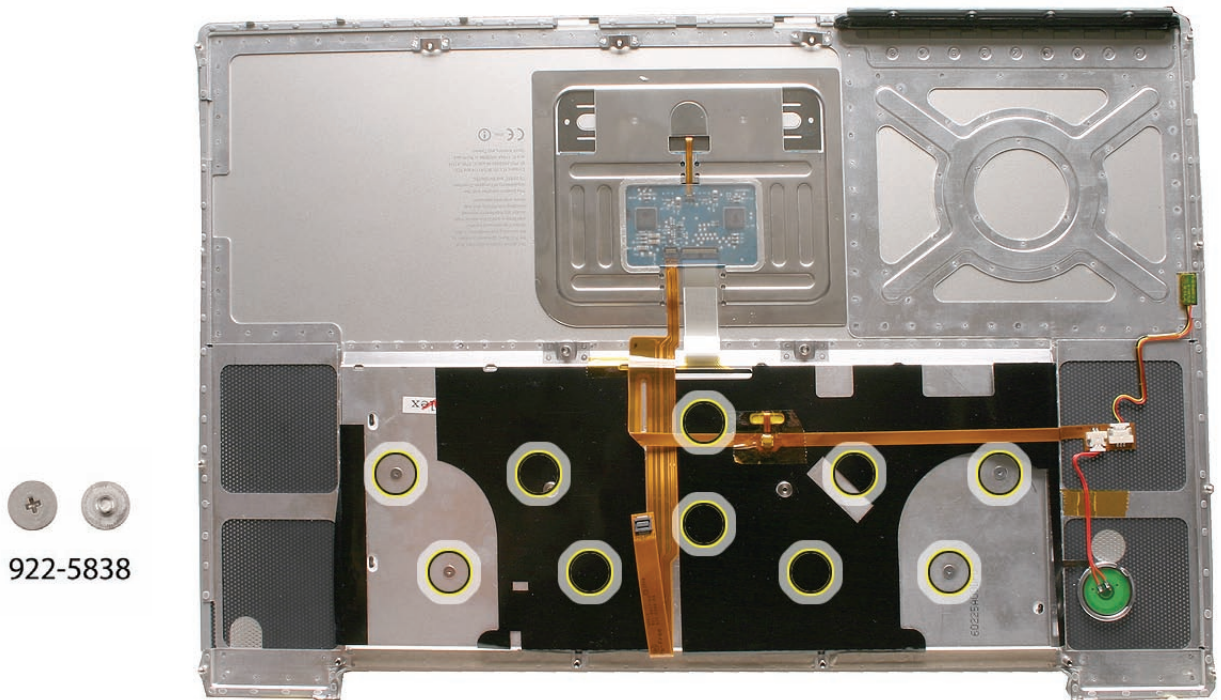

16. Carefully peel back the film as needed to access the screws.

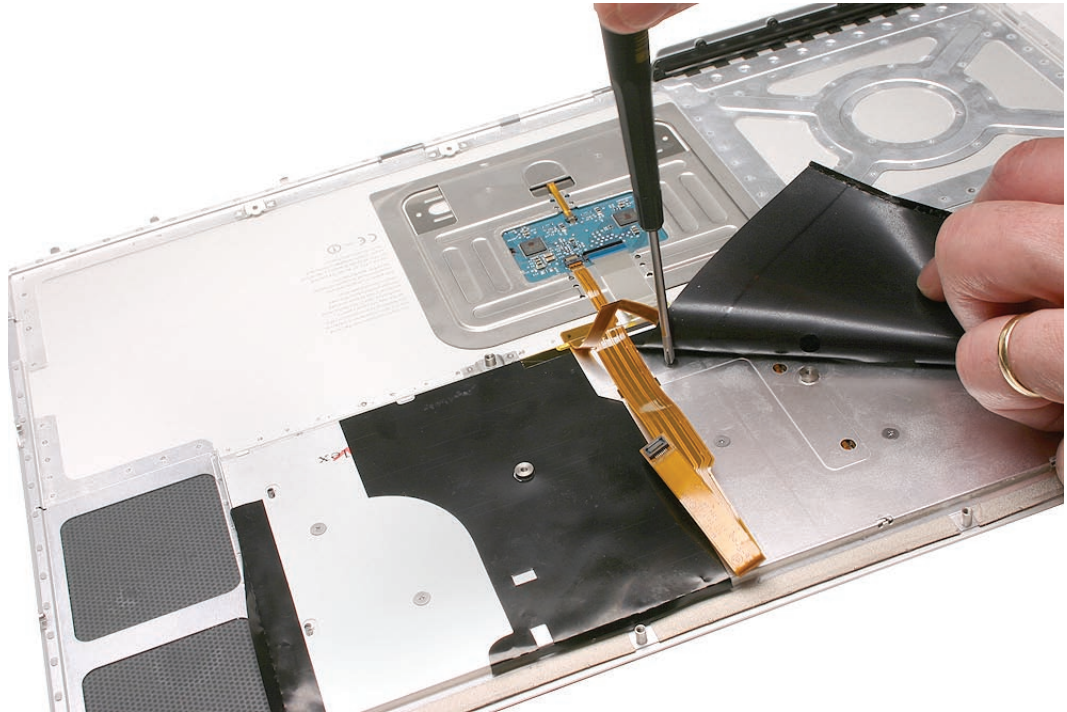

17. Note the six insert-tabs along the edge of the keyboard well, and two on each side. The following procedures release these tabs so that the keyboard can be removed.

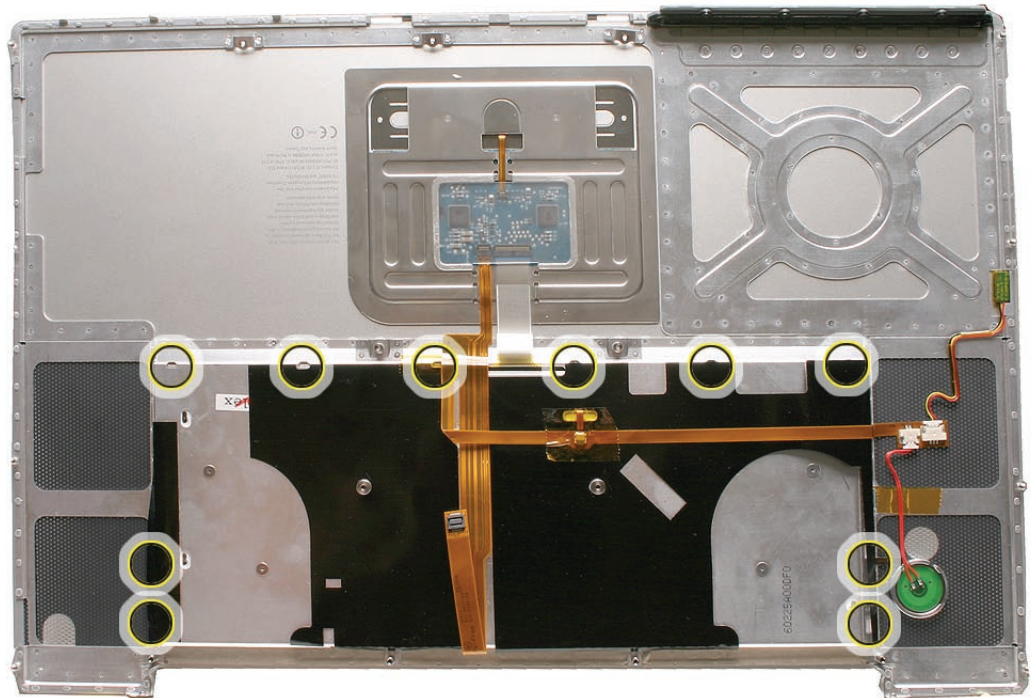

- 
18. To prevent the keyboard from falling out, support it with your hand, and raise the top case up vertically. **Note:** The keyboard does not have adhesive under it, as in previous models.



19. If needed, push through one of the top center keyboard screw holes, with the point of a black stick, to bow out the keyboard slightly.  
**Important:** Ensure that the hole used is a screw hole, or damage to other sensitive components may result. A black stick is used to avoid damaging the screw boss threads—do not use a metal tool.

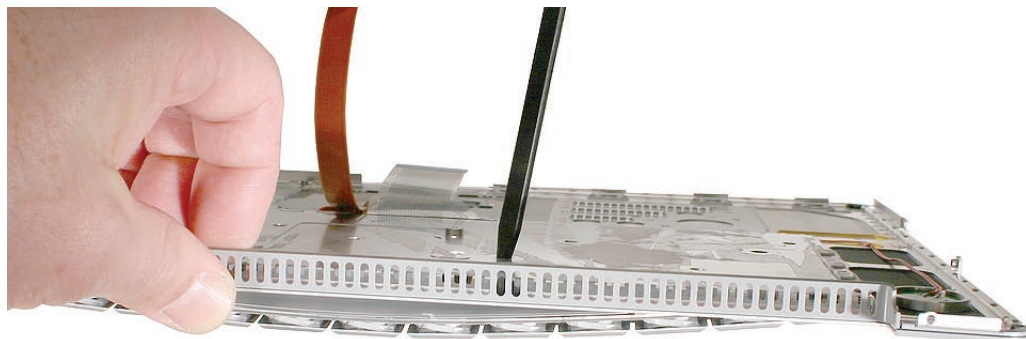

---

**20. Important:** During this procedure, do not allow the tabs or metal edge of the keyboard to scrape along the cosmetic surface of the top case, or damage can result.





21. Use your finger to hold the bowed out keyboard. Continue to bow it out only enough for the tabs on one side of the keyboard to release cleanly. Repeat for the other side.

**Important:** Do not bow the keyboard too much, or it may become permanently bent.



- 
22. Lift the keyboard up to release the tabs along the bottom edge and carefully thread out the flex cables.

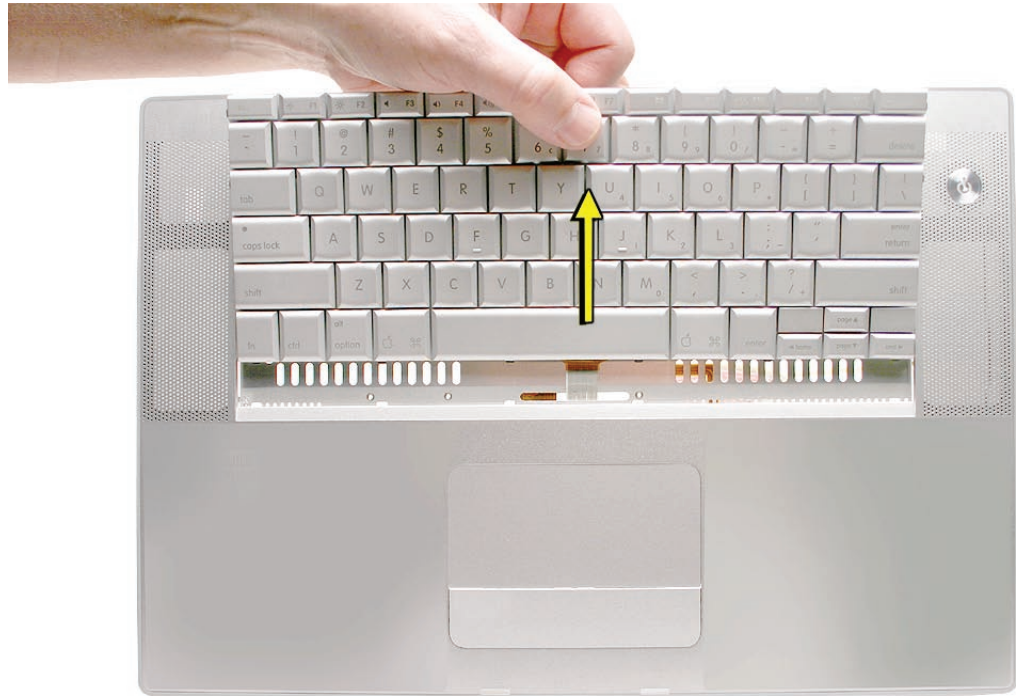

---

## Replacement Procedure

When replacing the keyboard, here are some key points to ensure:

- Prevention of scratches to the cosmetics of the top case
  - All tabs are properly seated
  - Keyboard lays flat
  - Cables not caught
  - Bend-tabs are not damaged
  - Screw holes align
  - Cable connectors are not damaged and cables are secure
  - Kapton tape is applied as before
  - Insulator film is correctly installed
1. Before replacing or installing a replacement keyboard, verify that the four bend-tabs along the bottom edge of the keyboard, are straight and parallel with the bottom edge (two are shown close-up, below).  
**Important:** Do not bend any other bend-tabs on the keyboard other than the four along the bottom. Other tabs hold the keyboard assembly together.



2. Guide the keyboard's flex cable through the slot in the top case, as shown. Make sure that it does not catch or bend behind the keyboard.

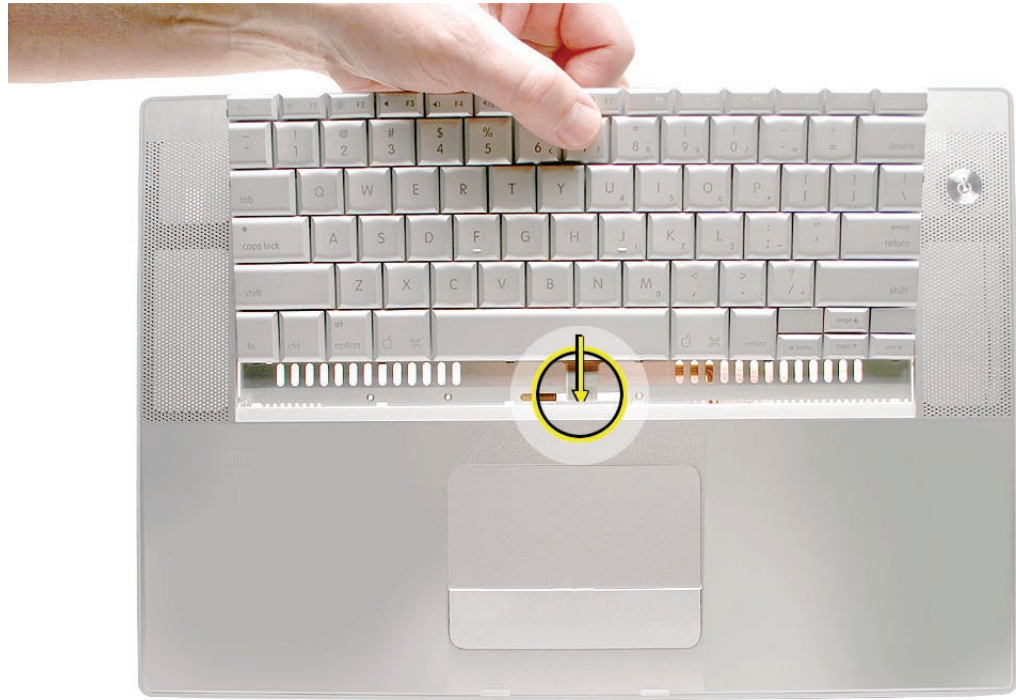

3. Verify that the small cable routes through the small slot, as shown.

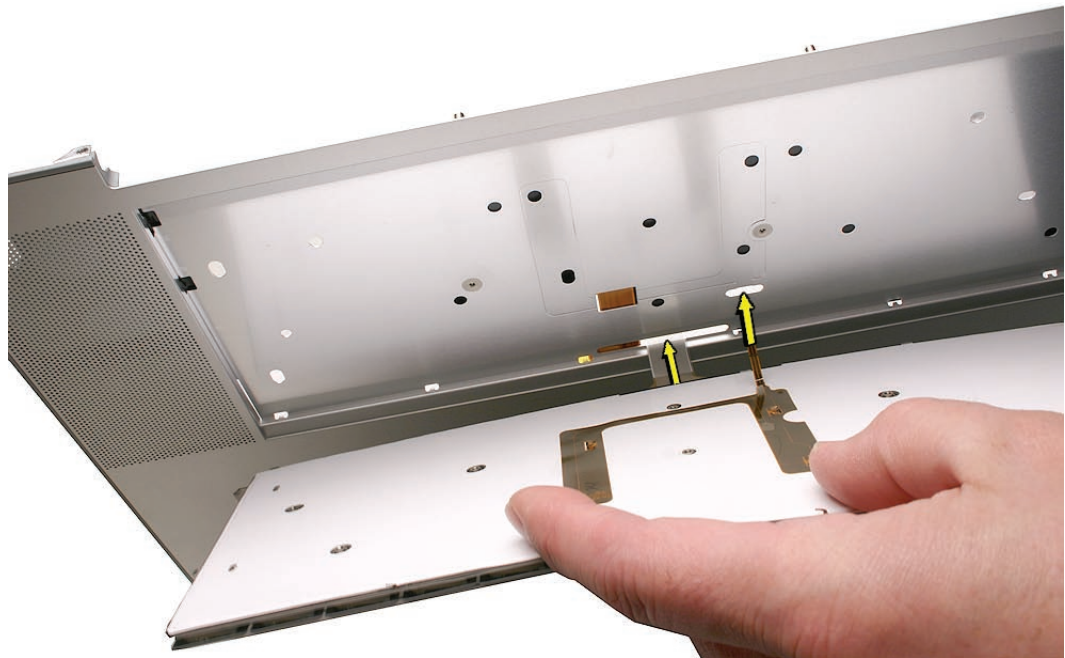

4. Lower the keyboard and seat all six tabs along the bottom, so that the keyboard sits flat and straight.



**Important:** During the next steps, do not allow the tabs or metal edge of the keyboard to scrape along the cosmetic surface of the top case, or damage can result.

5. While ensuring that the keyboard bottom stays straight and secure, hold the top of the keyboard in the middle, then with your other hand, bow in one side of the keyboard to engage the two tabs at the top into the top case.

**Important:** Do not bow the keyboard too much, or it may become permanently bent.



- 
6. Use the heel of your hand to hold in place the edge of the keyboard that was just inserted while holding the top of the keyboard with a finger on that hand, then use your other hand to help bow in the remaining side of the keyboard until it can be engaged.



7. While supporting the keyboard in the top case, verify that the keyboard lays flat and that all the tabs have seated properly.

**Note:** The keyboard will not lay flat if any of the tabs have not seated correctly. If the side tabs are not seating or are binding, check the bottom edge of the keyboard to verify that all the tabs are seated and the bottom of the keyboard is straight.

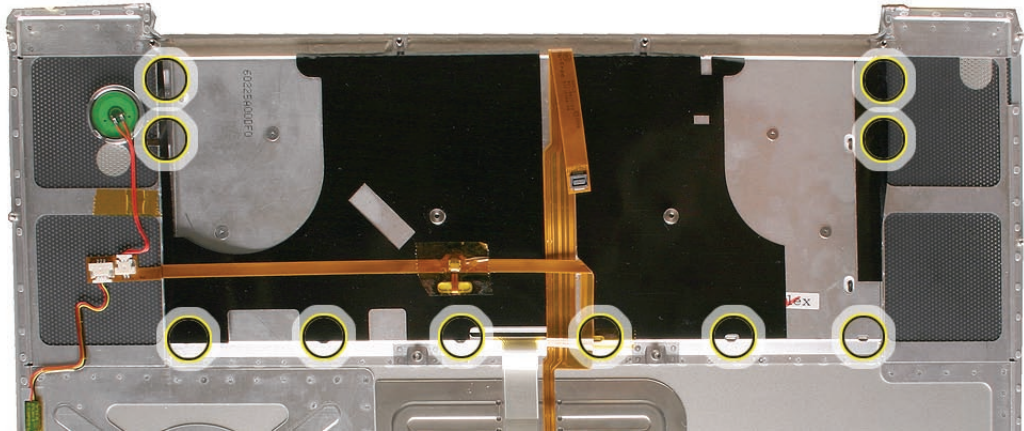

8. On the underside of the top case, peel back the film that covers the two tabs along each side. These tabs must be fully seated, as shown below, for the keyboard to seat properly. Carefully press on the opposing keyboard keys to help these seat, if needed.

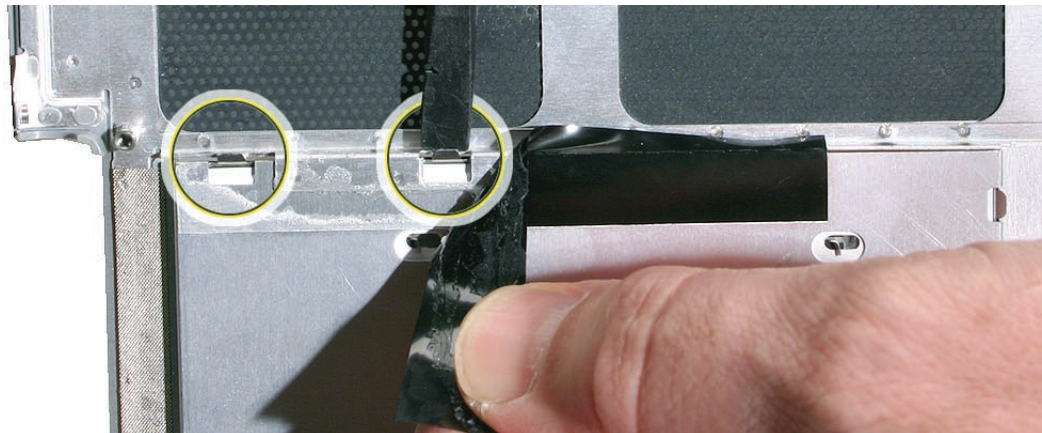

9. Verify that the bend-tabs are not caught.
10. Lay the top case upside down.
11. Pull on the flex cables to verify that they are not bent or caught under the keyboard, and that they extend to their connectors.
12. Verify that the screw holes align with the screw bosses.
13. Install all ten keyboard screws, starting from the middle and work out.

14. Bend the four bend-tabs over the metal of the bottom case to secure the bottom edge of the keyboard. Push up on the opposing part of the keyboard to raise it, as needed.
- Important:** The bend-tabs are delicate. Bend them carefully to avoid damage and no more than 90-degrees, or to, or within, any etch marks, if present. Avoid over bending.

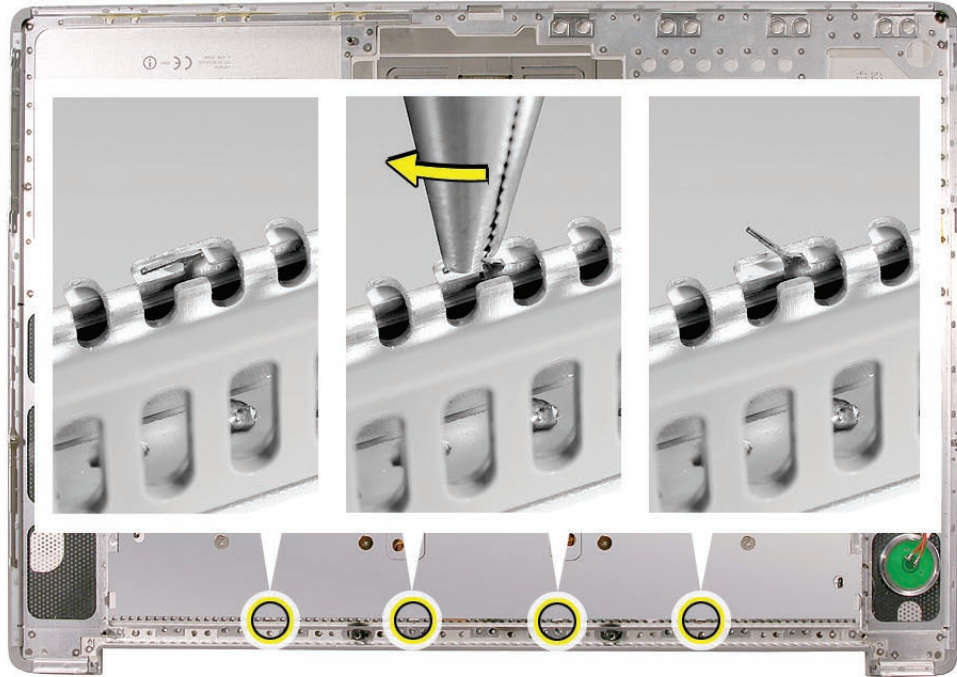



15. To install the small flex, use the pointed end of a black stick to support its middle, then with your finger, guide the loose end back and into the open connector. Secure the locking tab.

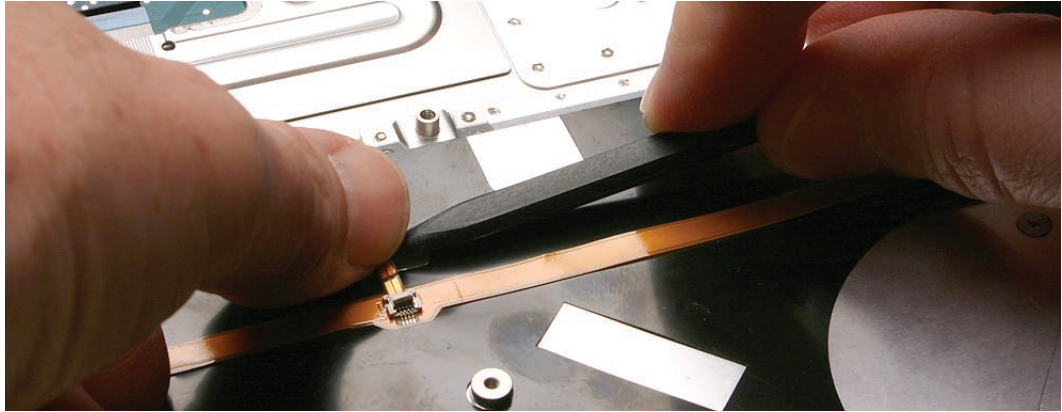
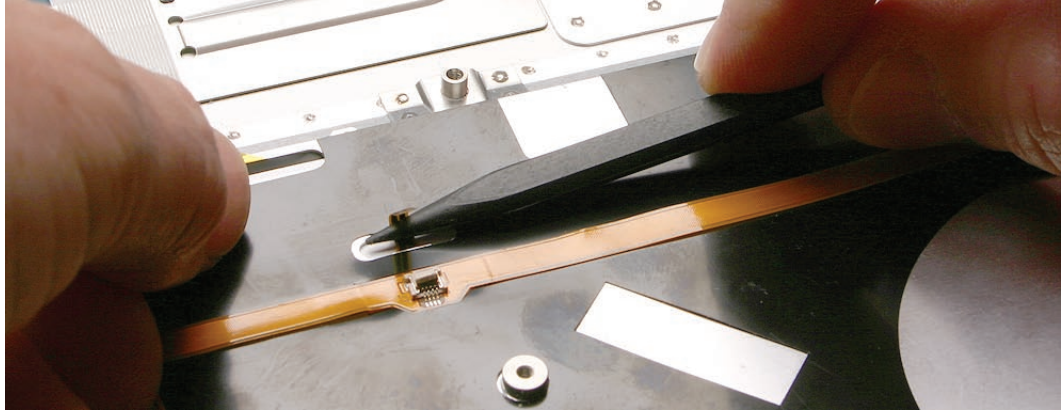

16. Install Kapton tape over the flex and connector as shown.

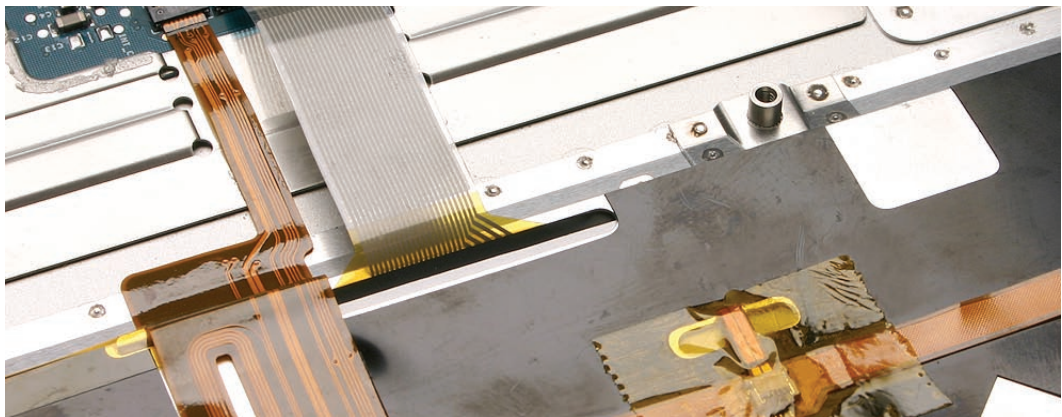

17. If installing a replacement keyboard, peel the adhesive protector off of the back of the large flex cable.
18. Support the cable with a black stick to prevent it from sticking to the top case and insert it straight and fully into the open connector. Secure the locking tab.

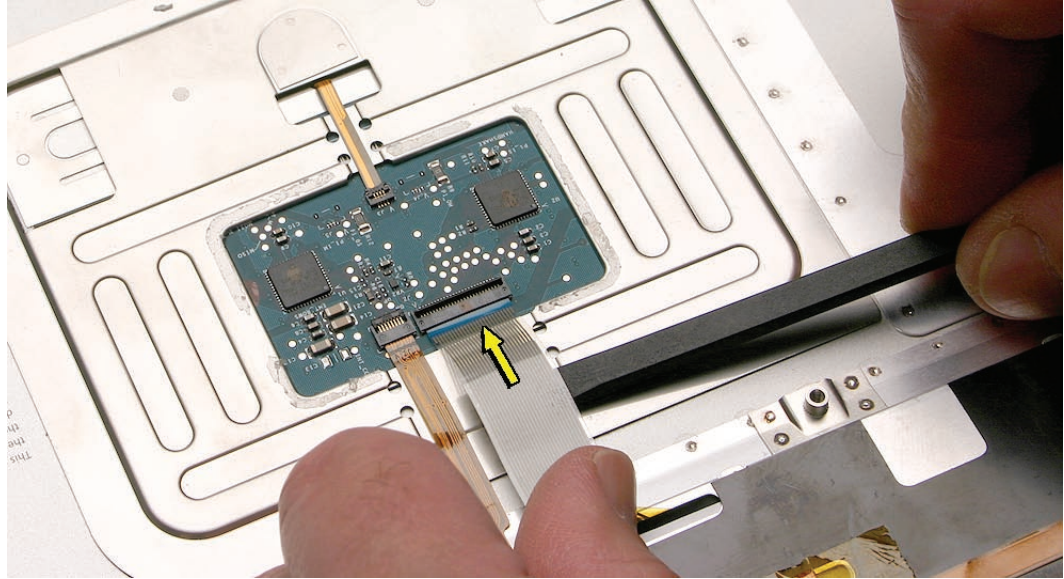

19. Press the cable flat to secure its adhesive.

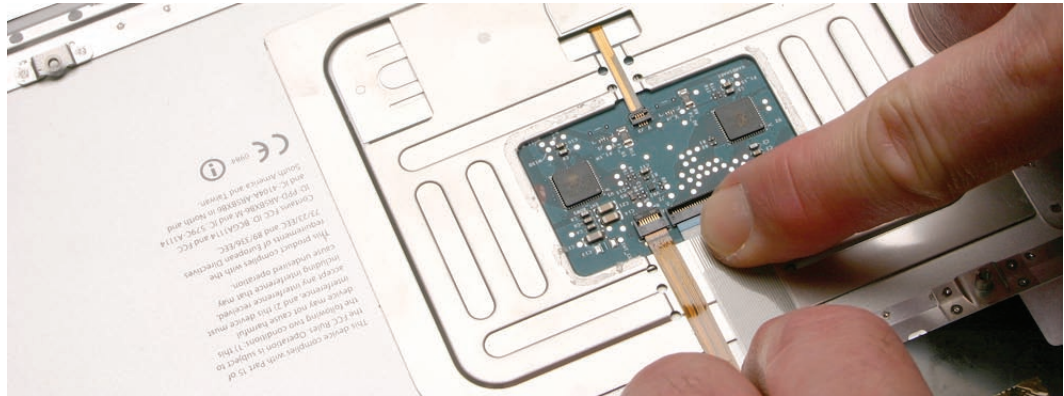

20. With a black stick, burnish down the edges of the protective cover that were lifted.

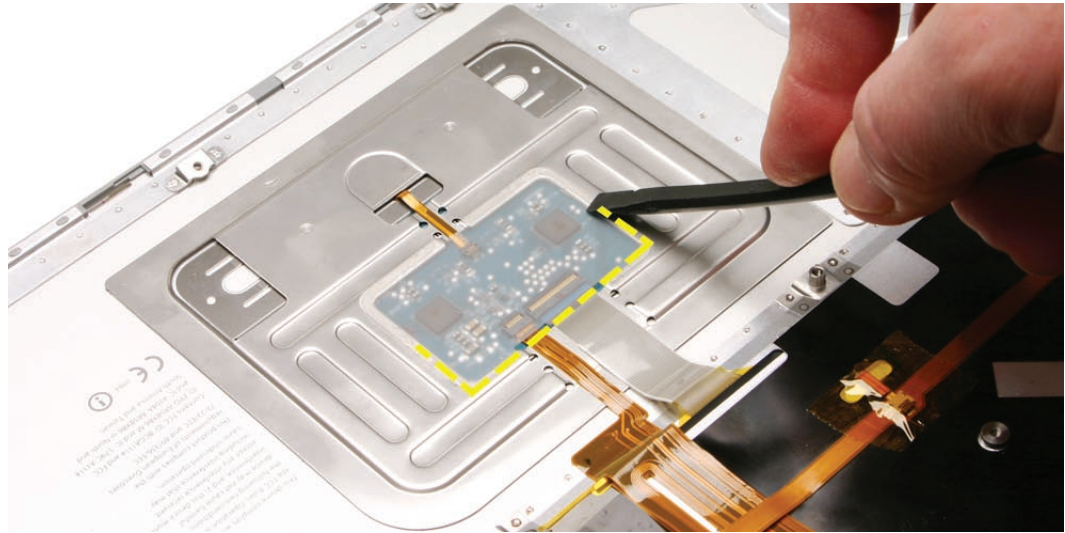

21. Run your finger along the film, where shown, to secure it over the edges.

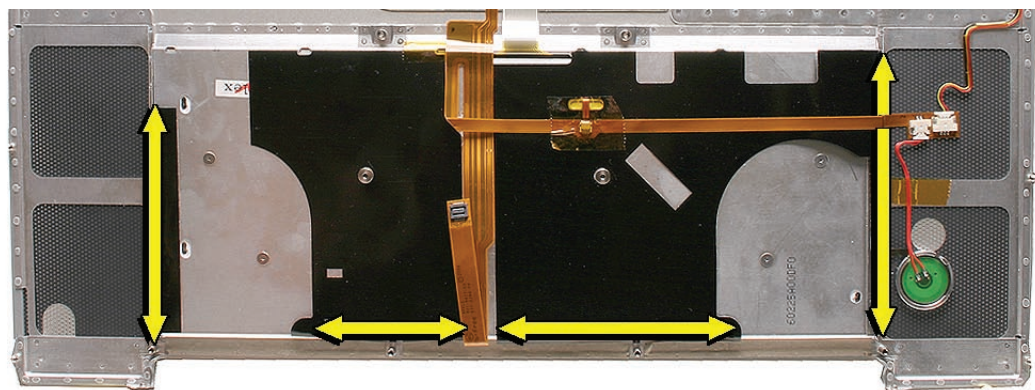

22. Reassemble the computer.

23. Testing the computer should include powering on, checking the keyboard and trackpad function.

Operate the computer in a darkened room to check for keyboard backlight function, and light leakage around the perimeter of the keyboard, speaker grill openings and side ports.



# AirPort Extreme Card

## Tools

This procedure requires the following tools:

- Torx T6 screwdriver (magnetized)
- Black stick (nylon probe 922-5065) or other non-conductive nylon or plastic flat-blade tool

## Preliminary Steps

Before you begin, remove the following:

- [Battery](#)
- [Top Case](#)

## Part Location

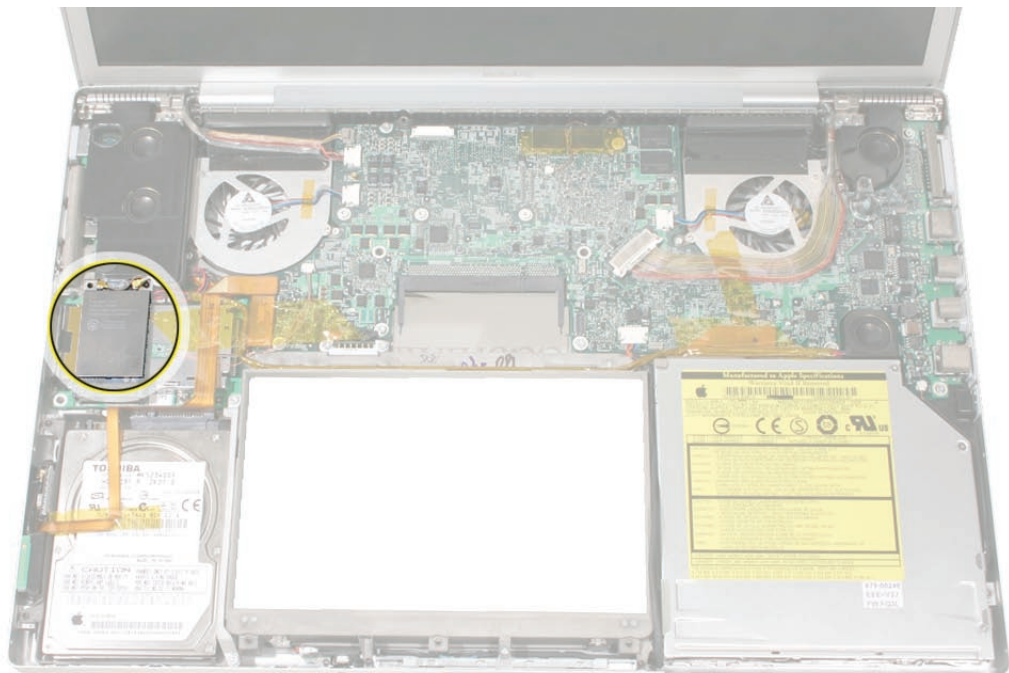

## Procedure

1. (a) MacBook Pro (17-inch): Remove two antenna connectors. Lift straight up.

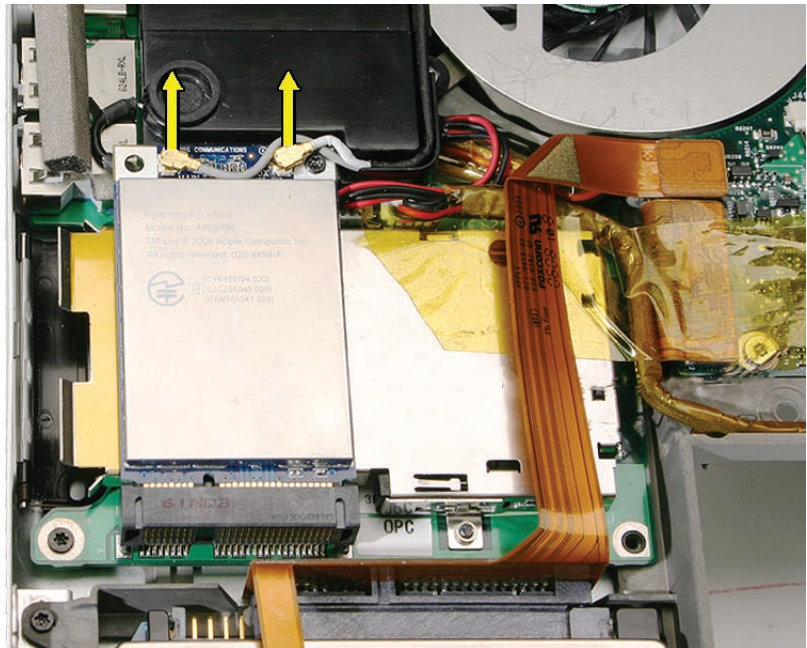

- (b) MacBook Pro (17-inch Core 2 Duo): Remove three antenna connectors. Lift straight up.

**Note:** The Airport card in the 17-inch Core 2 Duo has an EMI clip attached to the left of the card. Transfer this clip to the replacement card, if need be.

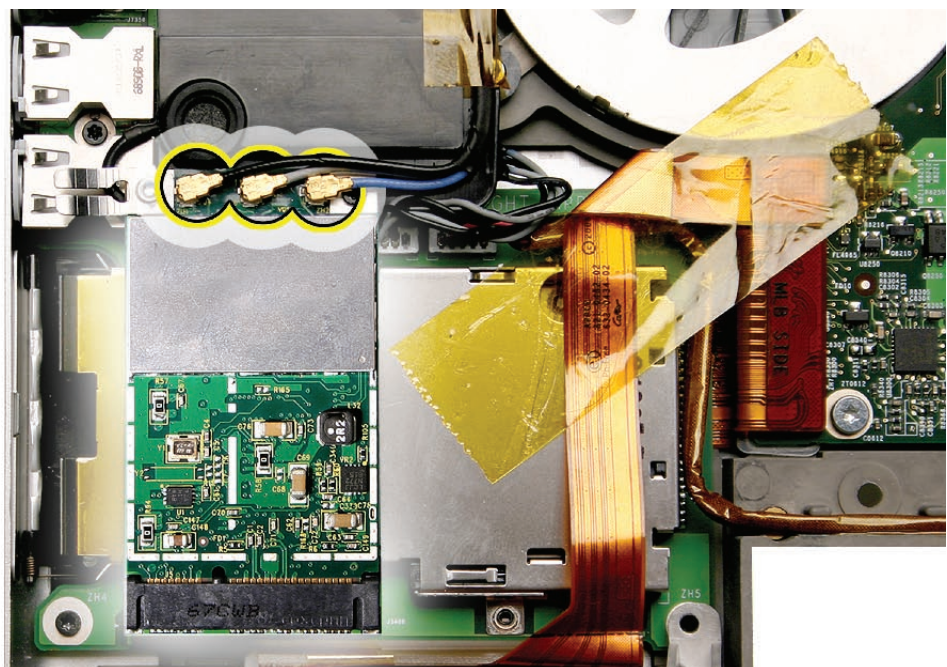

2. Remove the one screw. The card should rise up slightly.

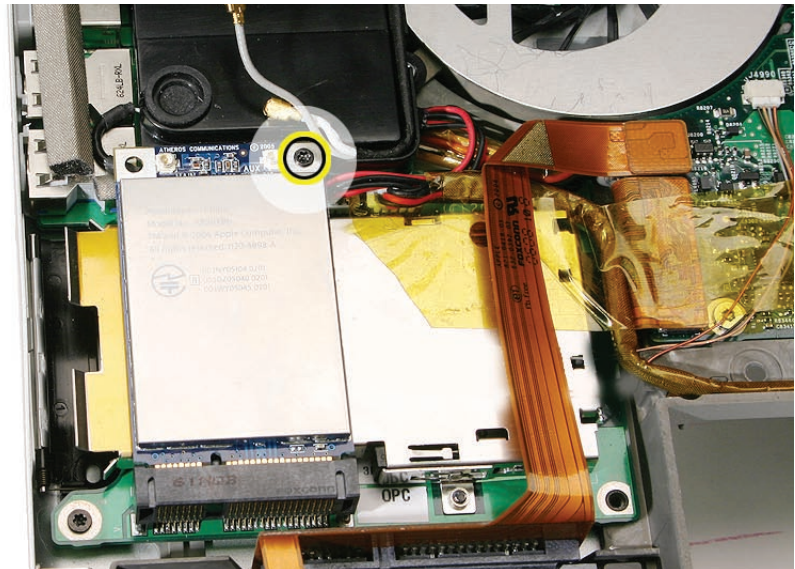

3. Pull the card straight out.

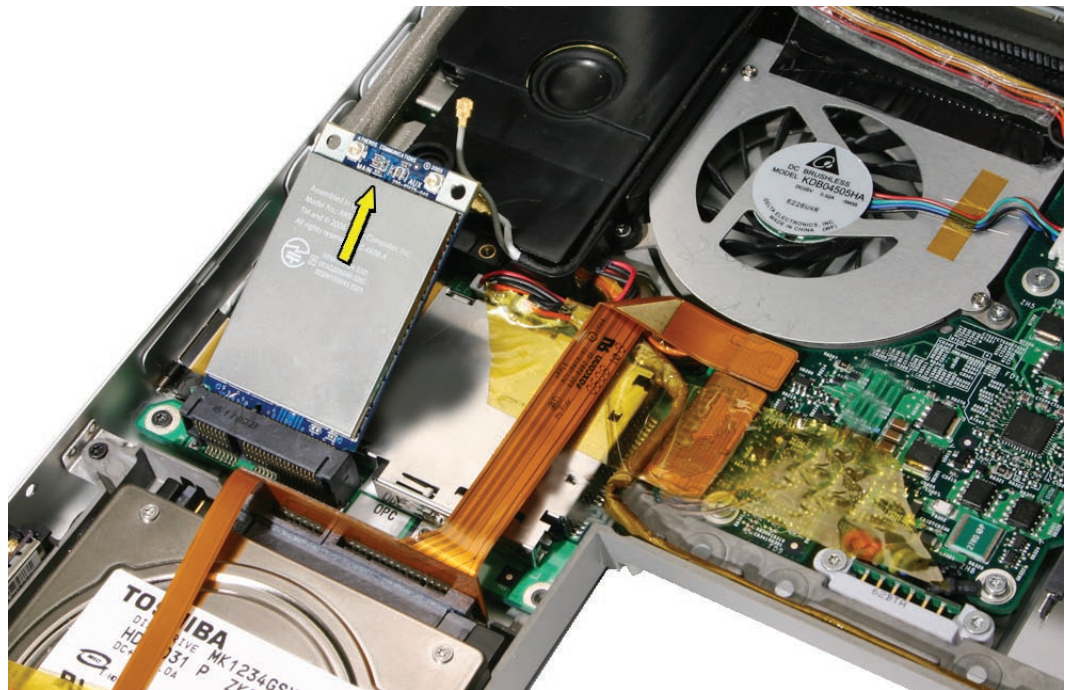

#### 4. Replacement Notes:

- Verify that the antenna cables lay flat within the channel along the edge of the speaker.

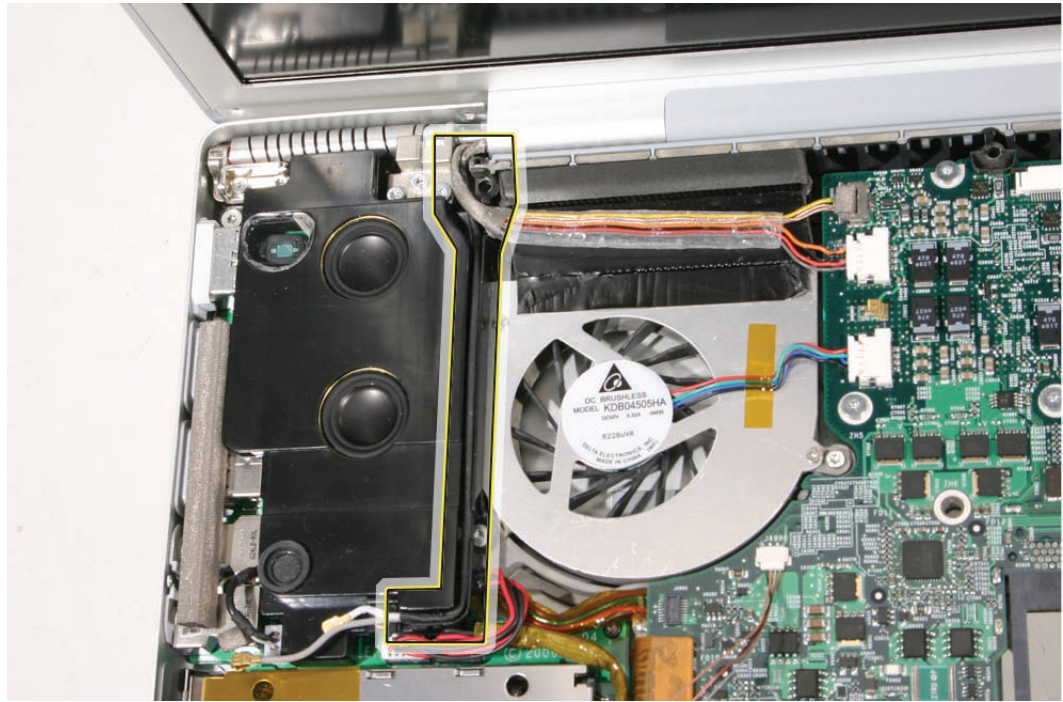

- If not, use Kapton tape to secure, as shown.

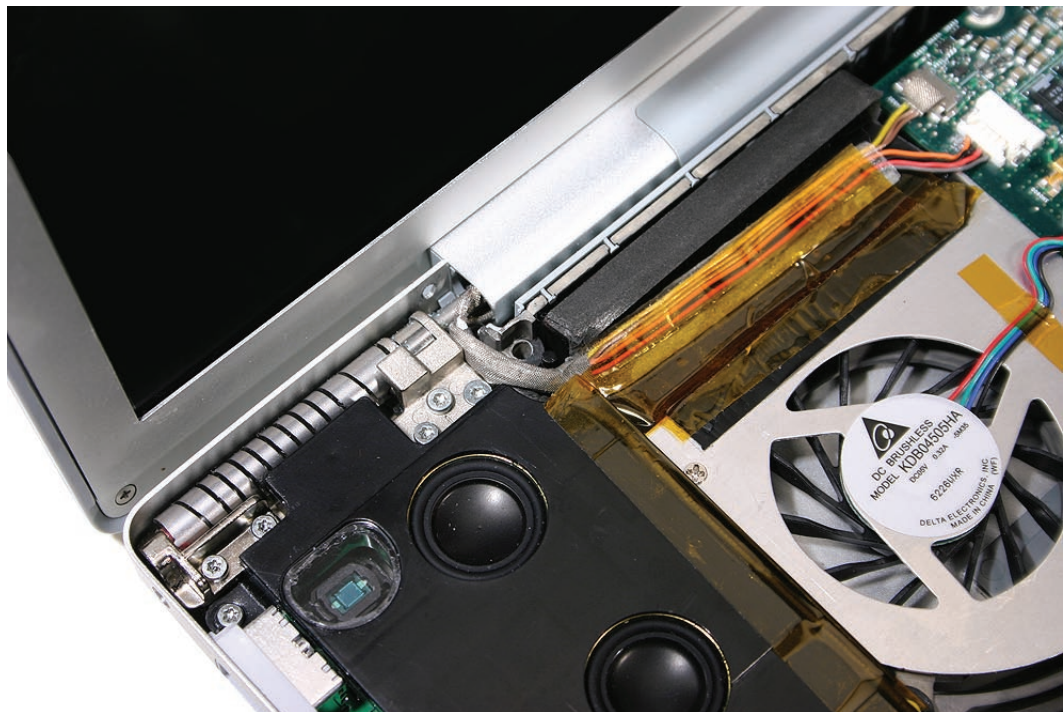

- Also verify that the cables for the antennas, camera and inverter route to the left of the pin and screw hole at the top right corner of the speaker.

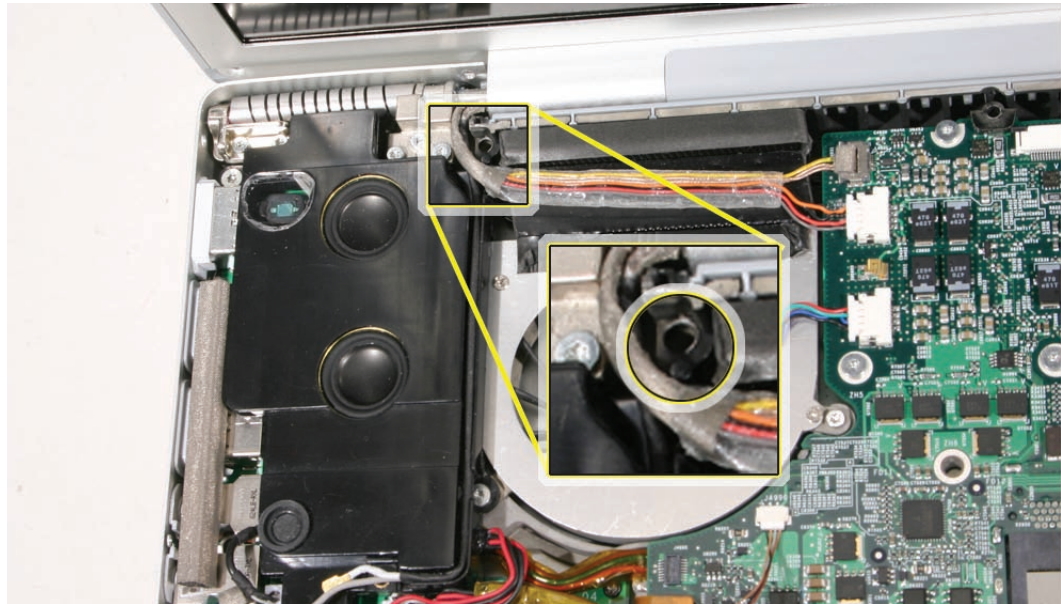

5. Reassemble the computer.
6. Testing should include AirPort function.





# Hard Drive

## Tools

This procedure requires the following tools:

- Torx T6 screwdriver (magnetized)
- Black stick (nylon probe 922-5065) or other non-conductive nylon or plastic flat-blade tool
- Kapton tape (922-1731) (0.5-inch x 12-yard roll)

## Preliminary Steps

Before you begin, remove the following:

- [Battery](#)
- [Top Case](#)

## Part Location

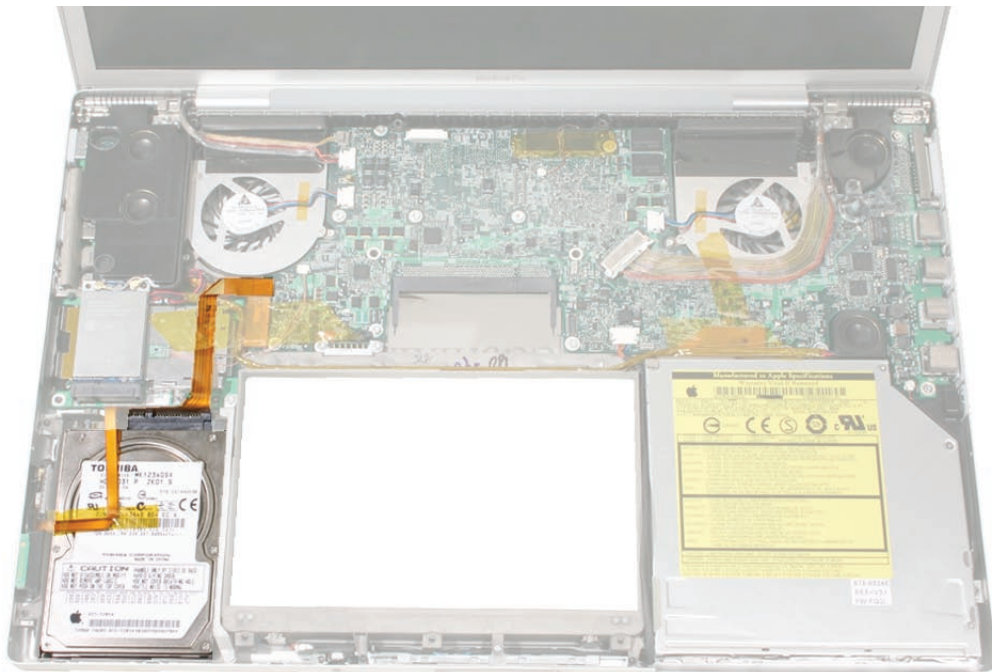

## Procedure

1. Disconnect the hard drive/bluetooth flex cable connector from the logic board.
2. Remove the two screws securing the hard drive holder.



3. Lift out the holder.



- Carefully peel up any tape that may be securing the hard drive flex cable to the drive.  
**Important:** Avoid tearing the hard drive label.
- Use a black stick to lift the right side of the hard drive and slide it right slightly to release its left side from the rubber grommets in the frame and to gain access to the flex connector.  
**Note:** Do not put strain on the flex cable extension that connects to the bluetooth card, as it can be dislodged from its connector.



- Disconnect the hard drive flex connector by pulling it straight back away from the hard drive.

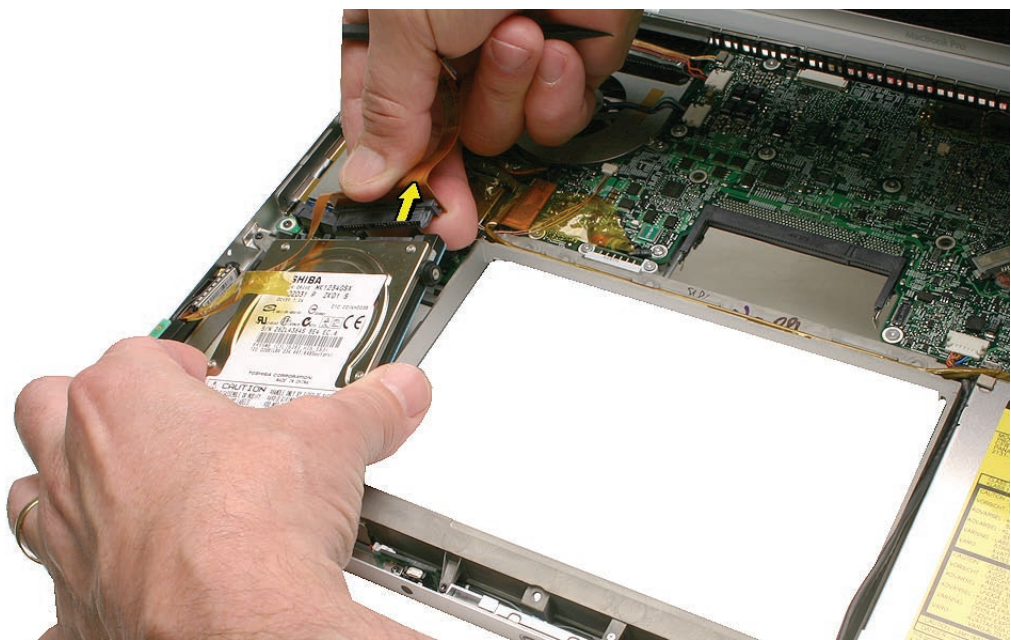

7. Transfer the hard drive screws and two grommets on the right side to the replacement drive.

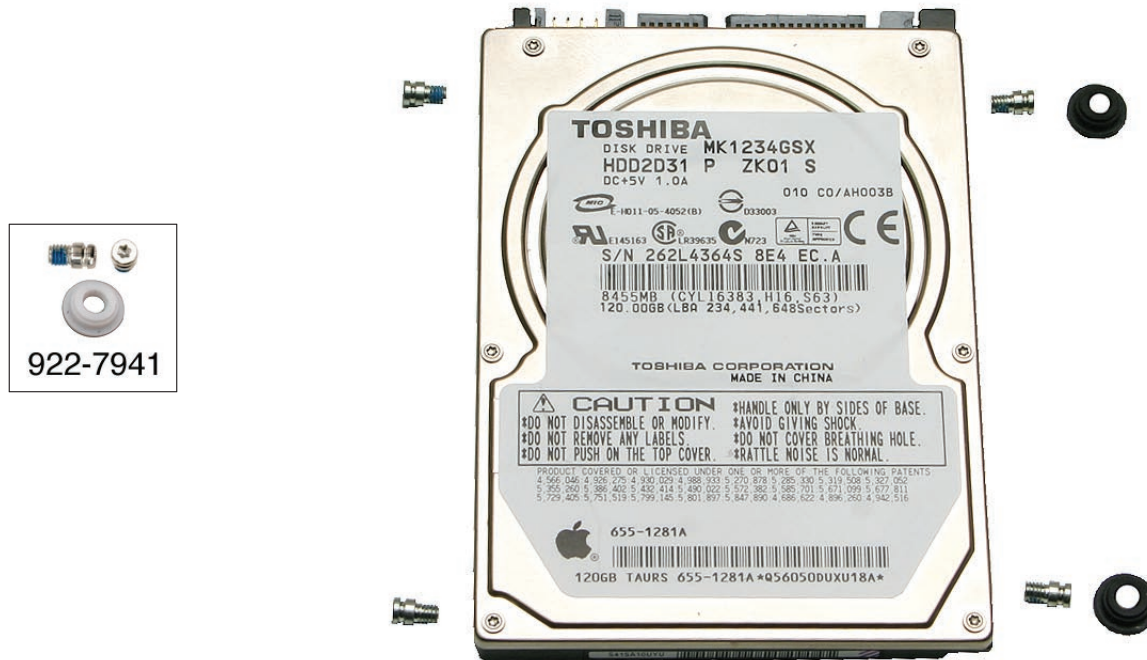

8. Verify that the two rubber grommets are installed on the bottom case frame
9. **Replacement Note:** When installing the hard drive, verify that the two screw heads installed on its left side, fit securely into the two grommets on the frame.

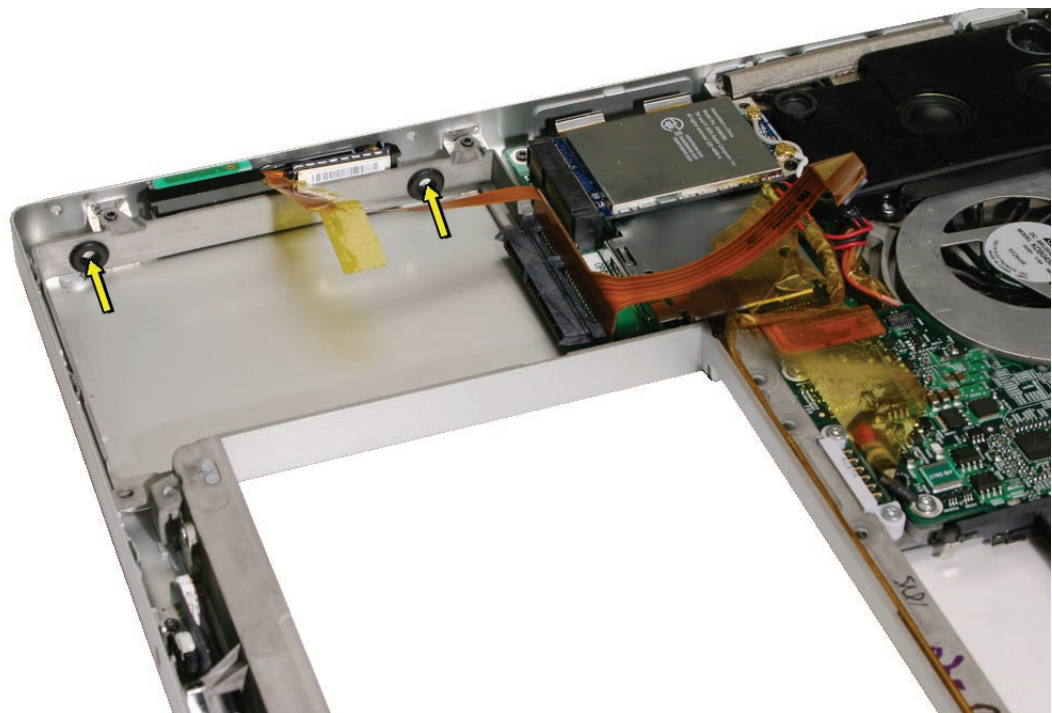



# Bluetooth Card and Antenna

## Tools

This procedure requires the following tools:

- Black stick (nylon probe 922-5065) or other non-conductive nylon or plastic flat-blade tool
- Kapton tape (922-1731) (0.5-inch x 12-yard roll)

## Preliminary Steps

Before you begin, remove the following:

- [Battery](#)
- [Top Case](#)

## Part Location

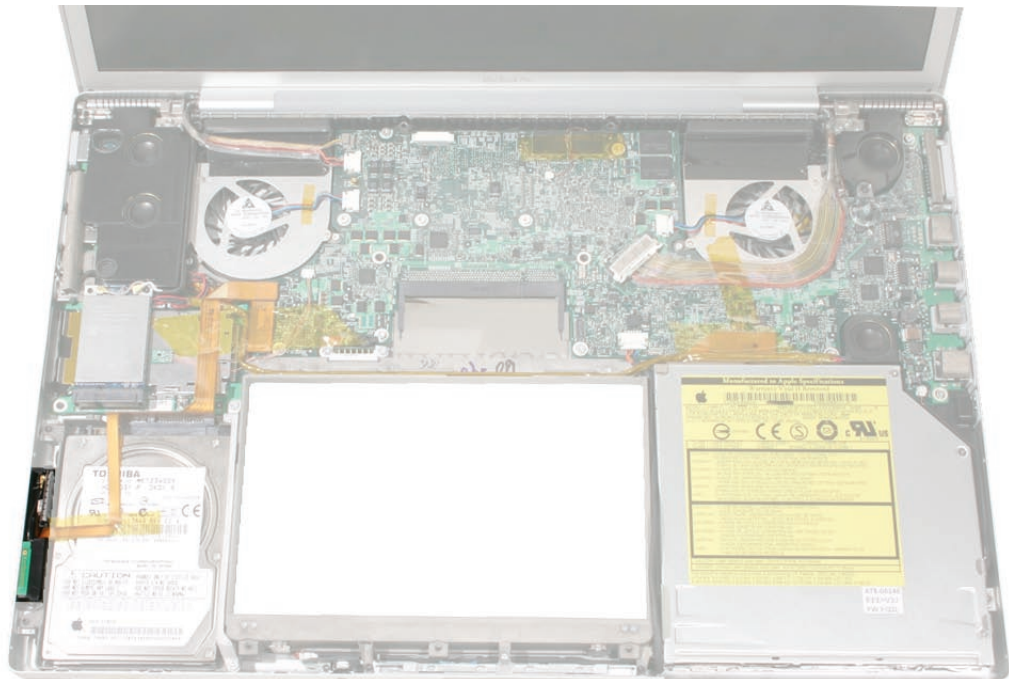

## Procedure

The bluetooth assembly includes the bluetooth card and antenna installed onto a bracket.

1. Lift the bluetooth bracket assembly out of its channel.



2. If the bracket is wrapped in EMI foil, carefully remove the foil below as shown in the following series of illustrations.

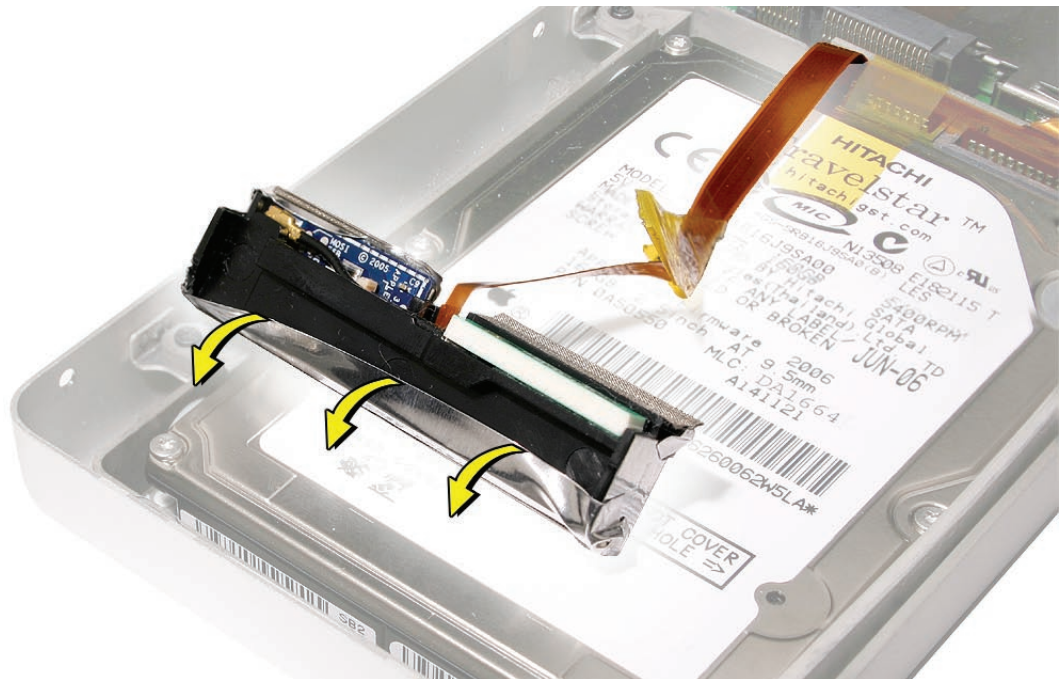

3. (a) Carefully and slowly peel the foil from the bottom first, (b) then down the back side of the bracket, and (c) then the top last. If it remains intact enough for reuse, set aside the foil for reinstallation. Otherwise, the EMI shield is available to order as a separate part (922-7969).

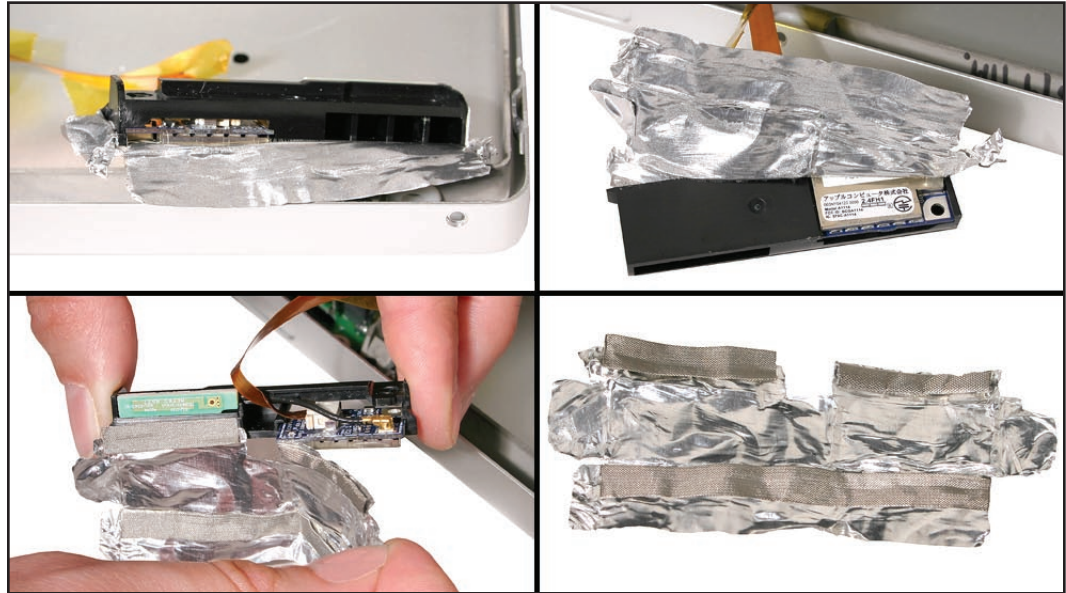

4. Slide the bluetooth card out of the bracket.



- 5.

6. Lift the antenna cable connector straight off to disconnect.



7. If replacing the bluetooth card, disconnect the flex cable by releasing the sliding lock.

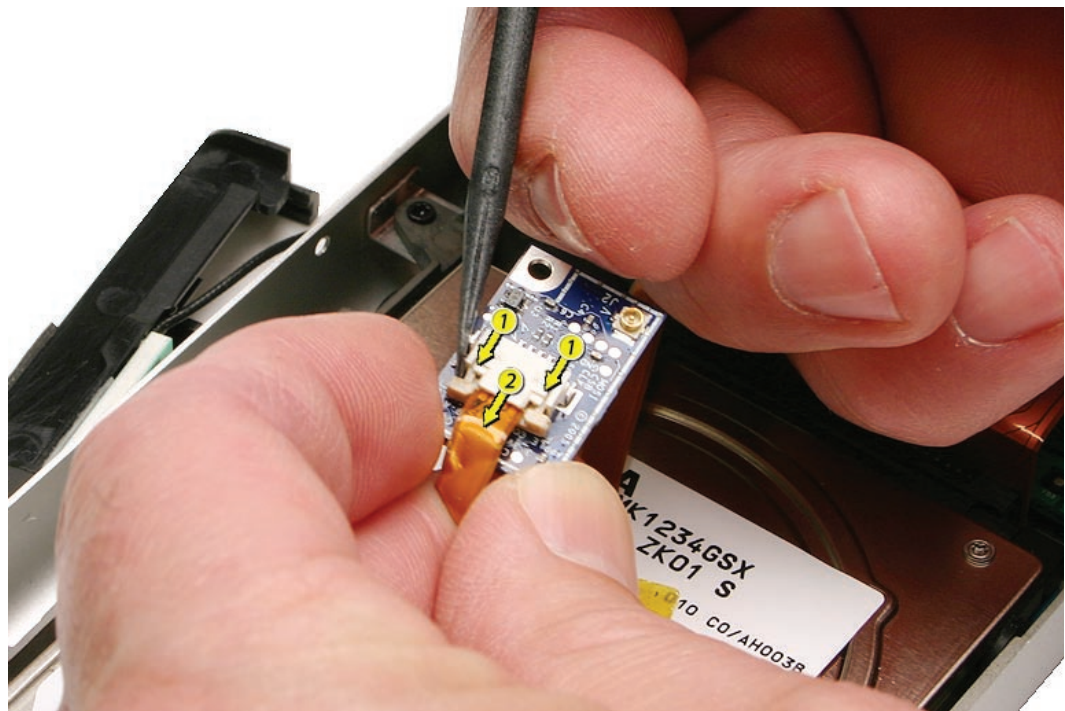



- 
8. To replace the antenna, pry the antenna board off the plastic bracket. Make sure that the adhesive strip stays on the bracket, and keep it clean.

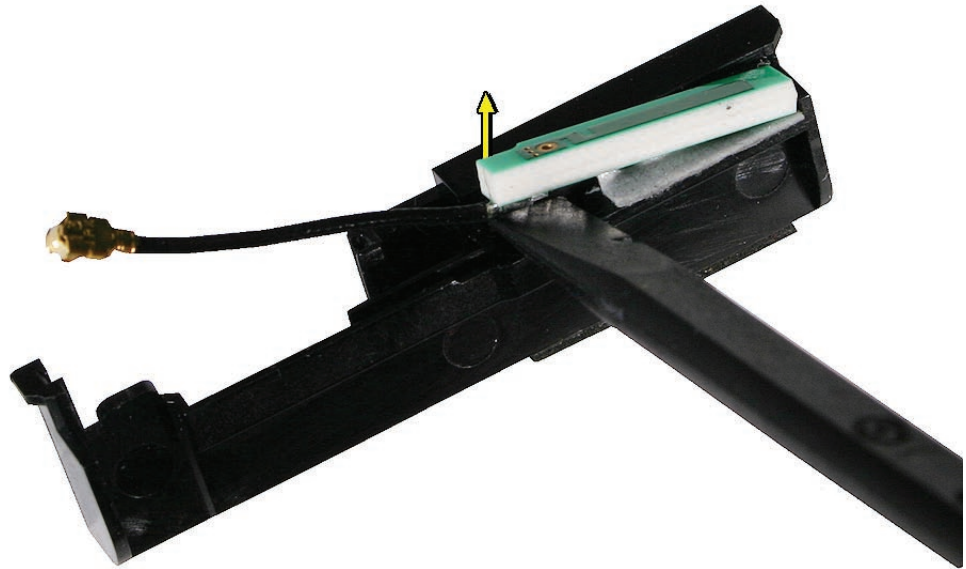

9. **Important:** If the bracket adhesive is damaged or missing, order a replacement bracket. The adhesive must be in good condition and perfectly level for proper antenna alignment.

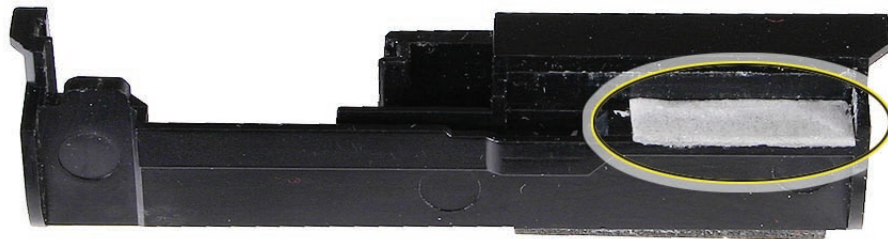

- 
10. Verify that the rubber pad is in place on the bottom of the bracket. Order a new bracket, if needed.

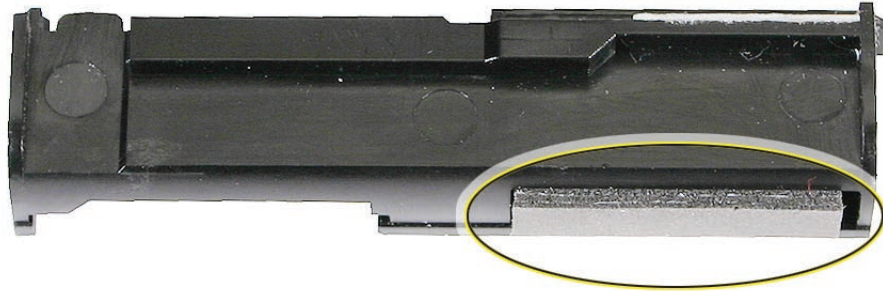

11. Install a replacement antenna as shown below. **Note:** The antenna cable is attached on the bottom of the antenna board, and routes in a channel in the bracket.

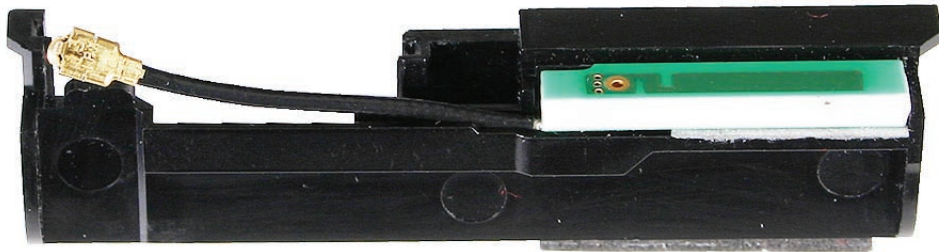

12. If present, re-install the foil EMI shield, using a reverse order of step 3 (see previous) starting with the top. If need be, the EMI shield is available to order as a separate part (922-7969).





# Infrared Board

## Tools

This procedure requires the following tools:

- Torx T6 screwdriver (magnetized)
- Black stick (nylon probe 922-5065) or other non-conductive nylon or plastic flat-blade tool

## Preliminary Steps

Before you begin, remove the following:

- [Battery](#)
- [Top Case](#)

## Part Location

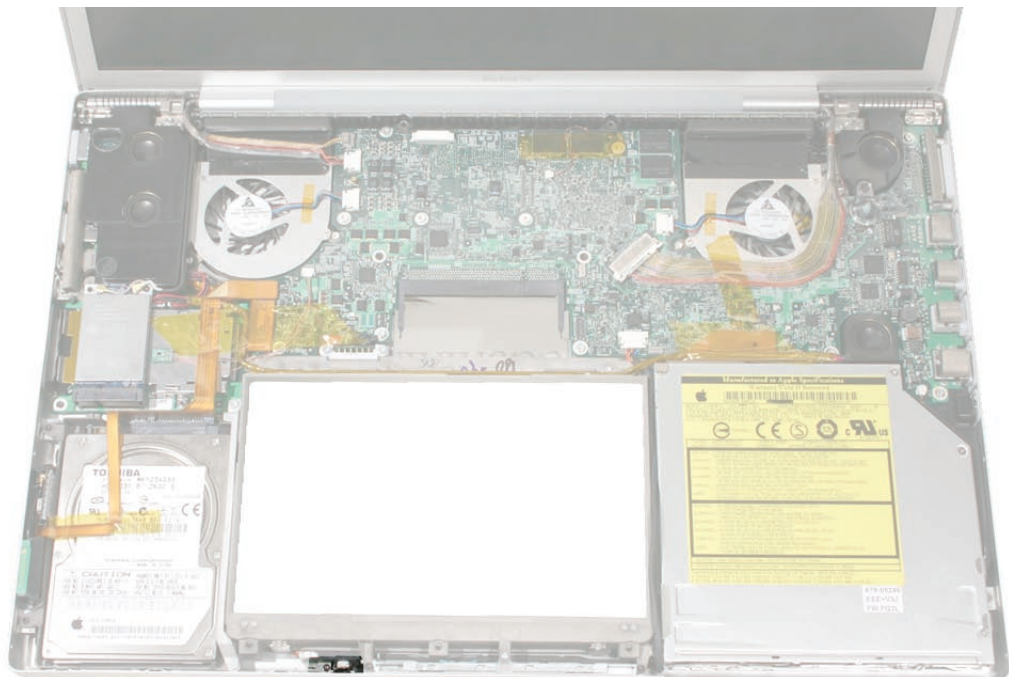

## Procedure

**Note:** The infrared board cable (which is combined with the sleep LED light cable) is part of the bottom case assembly and is not replaceable separately.

1. Remove the Torx T6 screw.

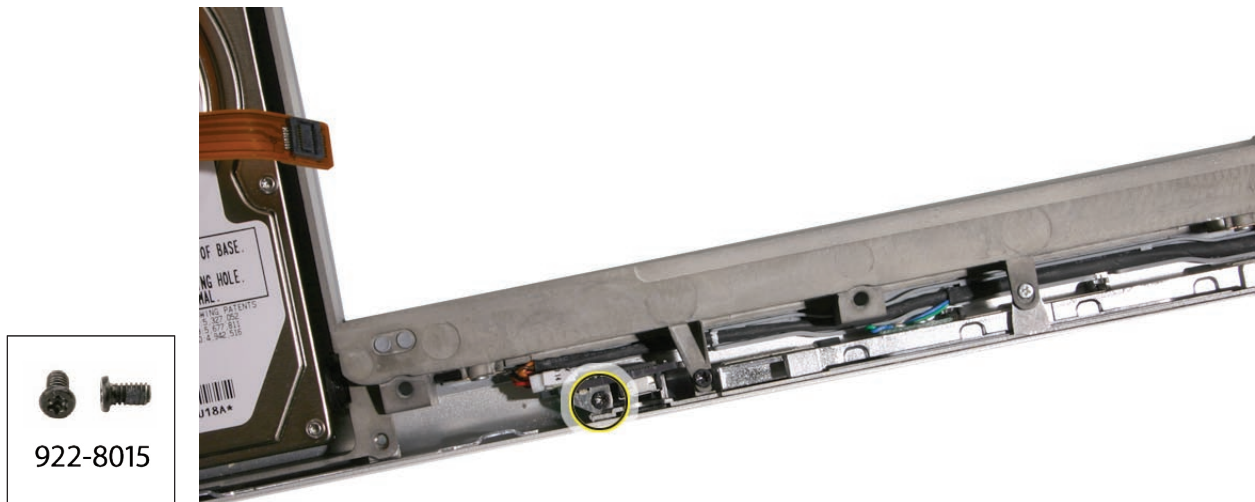

2. Lift out the infrared board.

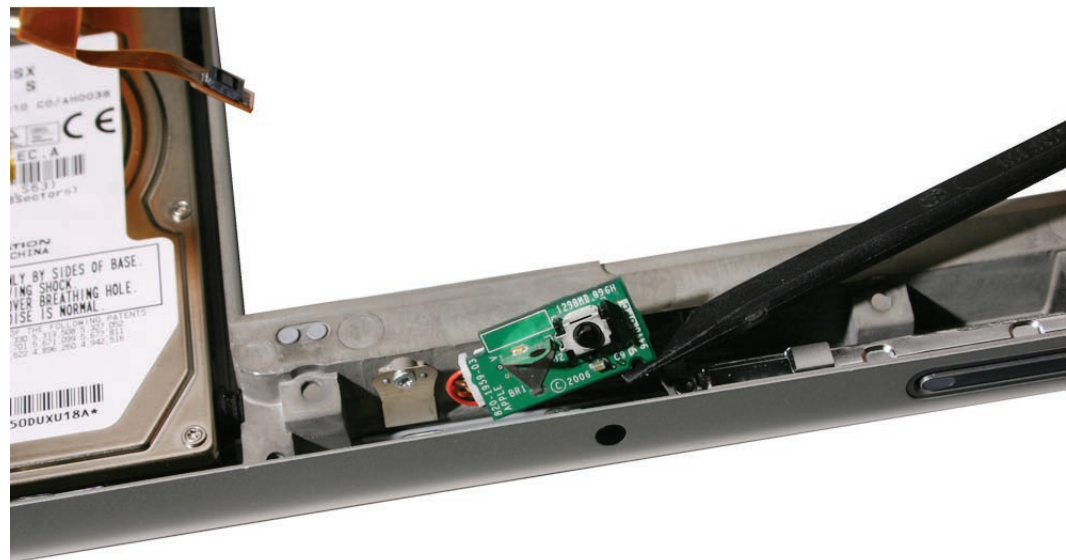

3. Disconnect the infrared board cable.

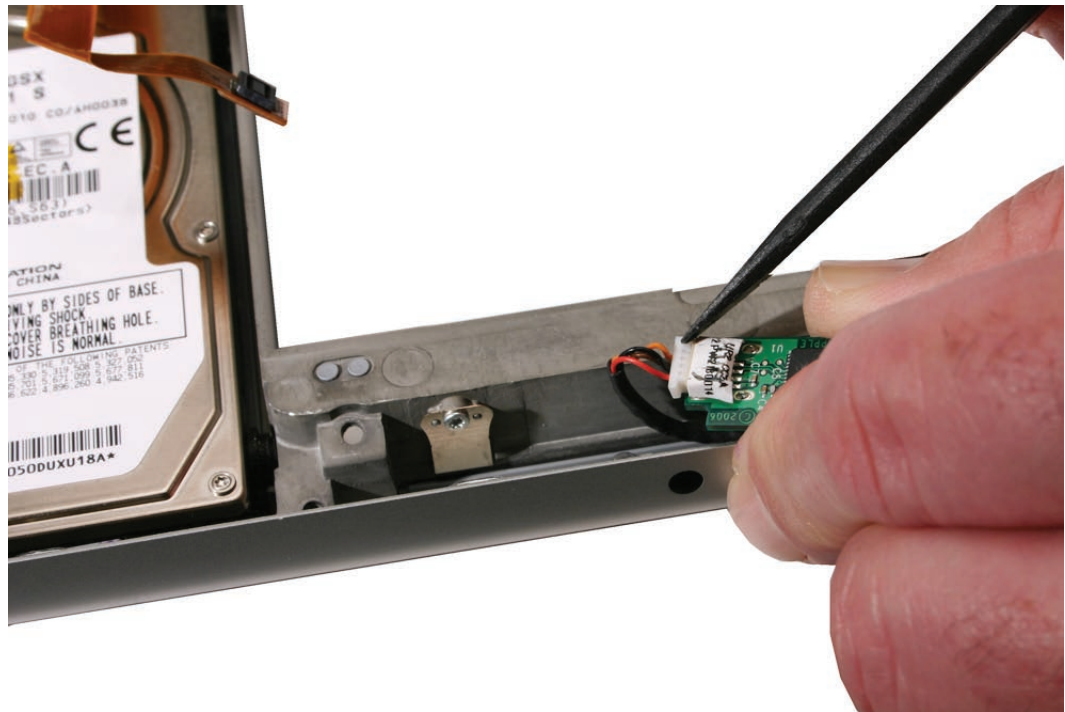

## Replacement Procedure

1. Install the cable onto the infrared board.
2. Insert the card into the channel and verify that the notch in the board rests over the rounded bead, shown.

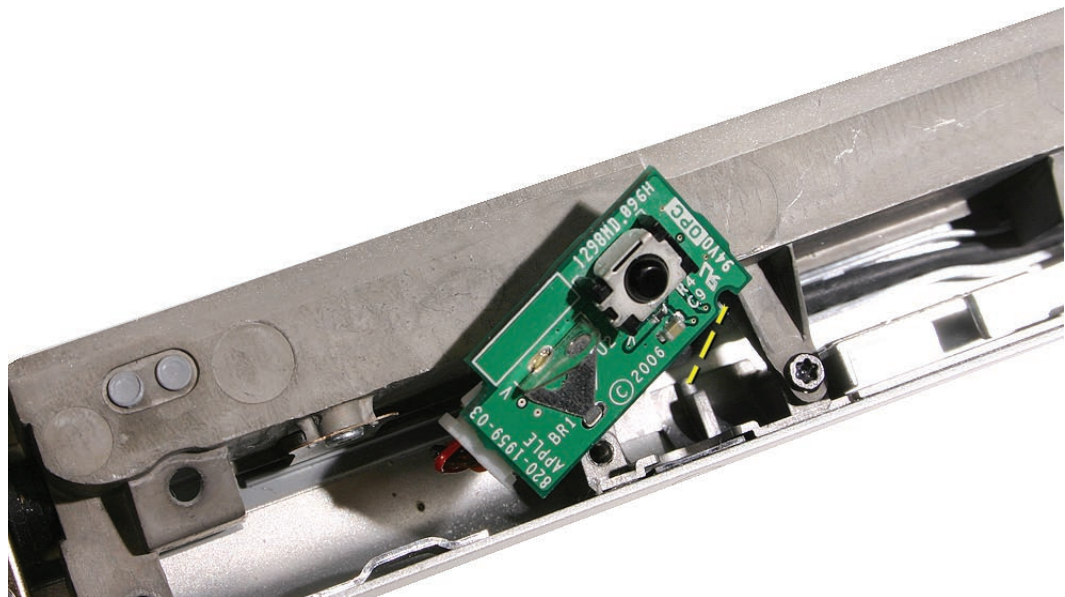

3. Push the card forward with a black stick while installing the screw, to ensure that the card secures straight.

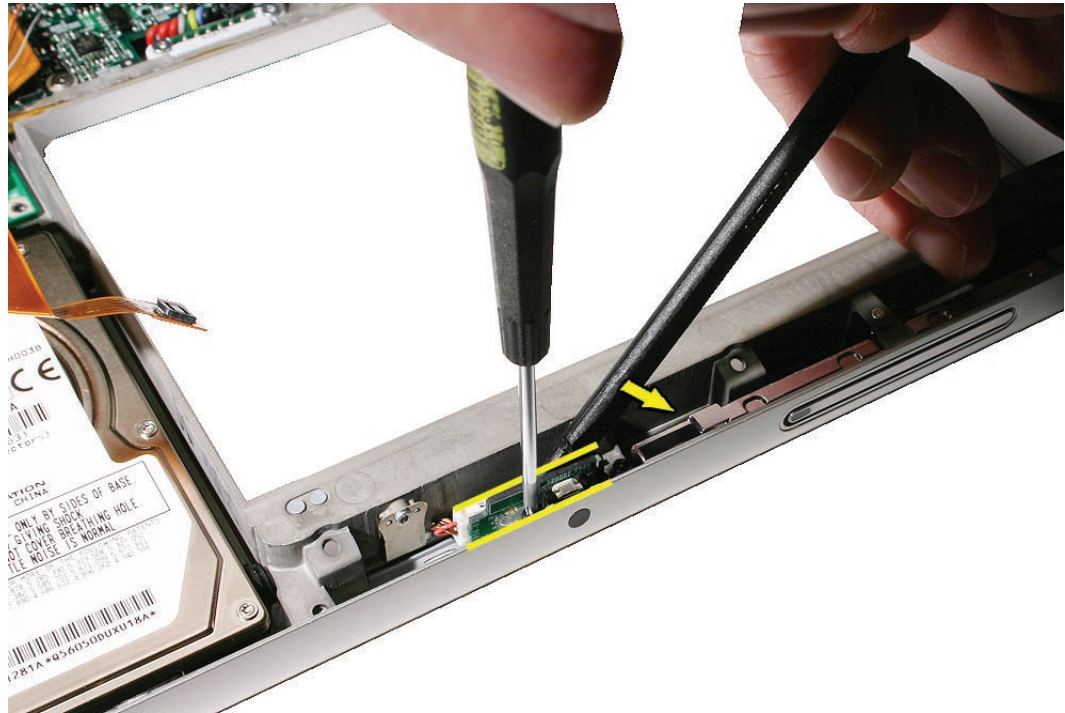

4. Verify that the top of the board is level with the top edge of the bottom case.

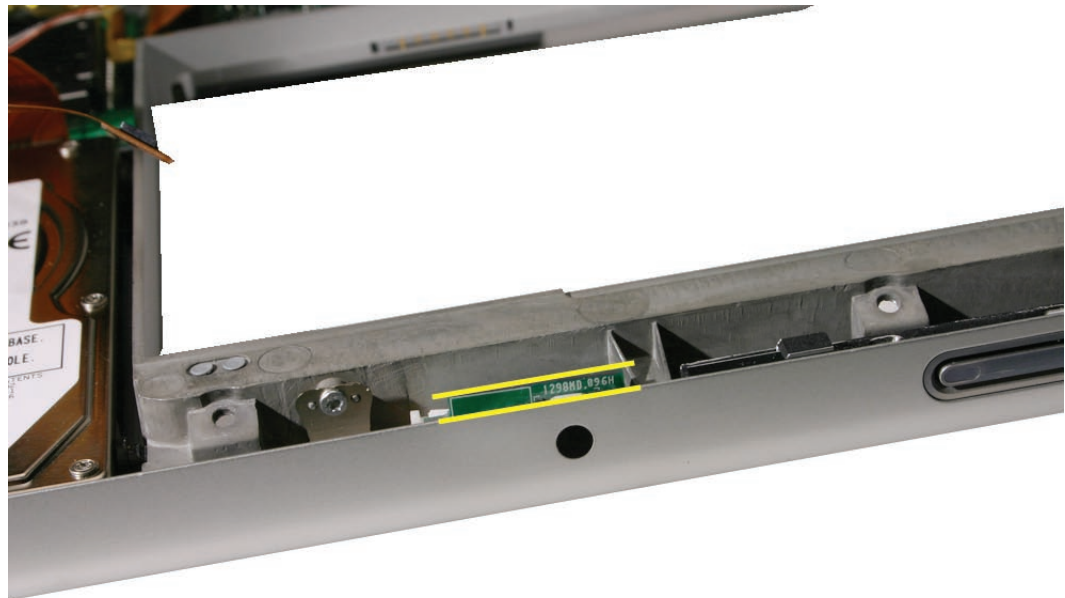



# Optical Drive

## Tools

This procedure requires the following tools:

- #0 Phillips screwdriver (magnetized)
- Torx T6 screwdriver (magnetized)
- Black stick (nylon probe 922-5065) or other non-conductive nylon or plastic flat-blade tool
- Kapton tape (922-1731) (0.5-inch x 12-yard roll)

## Preliminary Steps

Before you begin, remove the following:

- [Battery](#)
- [Top Case](#)

## Part Location

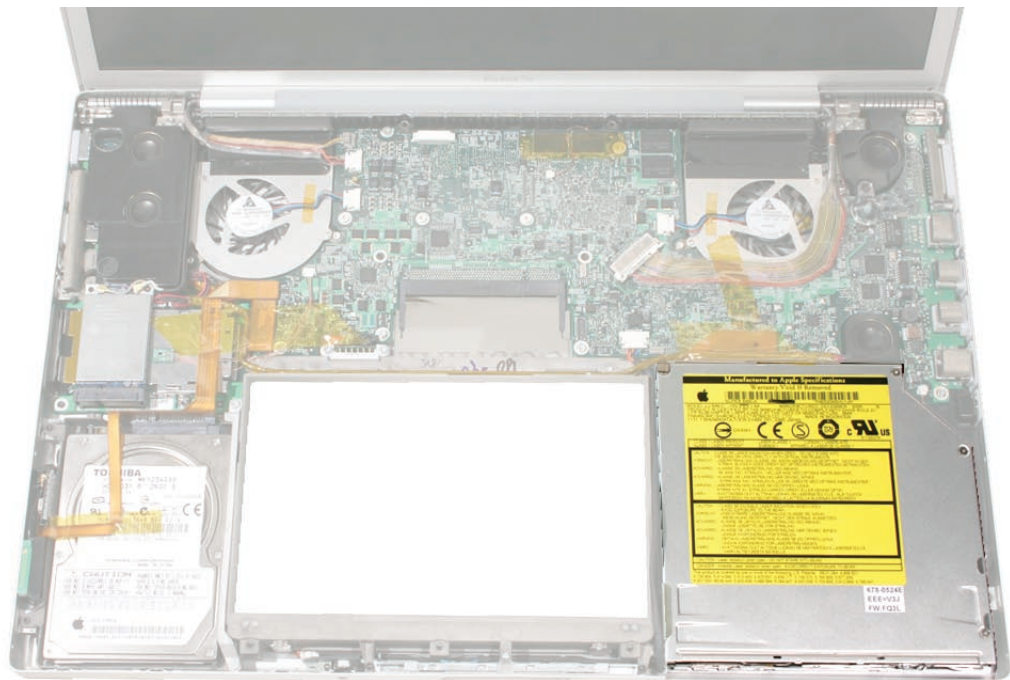

## Procedure

1. Disconnect the flex connector. Peel up tape, if any.
2. Remove the three screws. Use a black stick to carefully move wires to access two of the screws, as shown below.

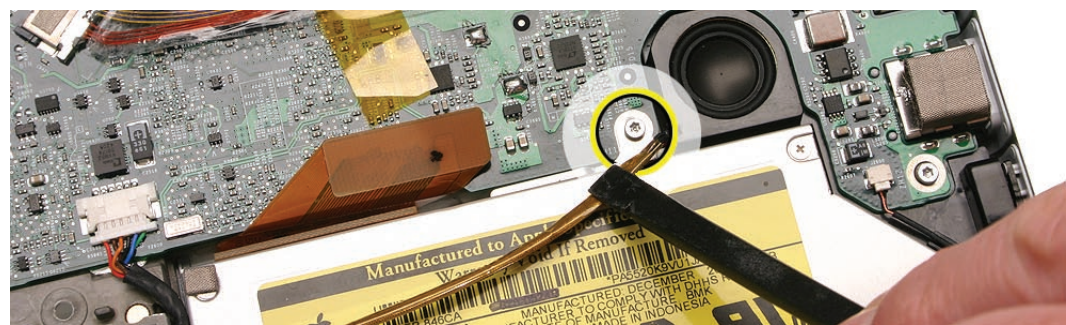



3. Lift up the front of the drive and slide it forward and out.  
**Note:** The flex cable guides under the right speaker cable.

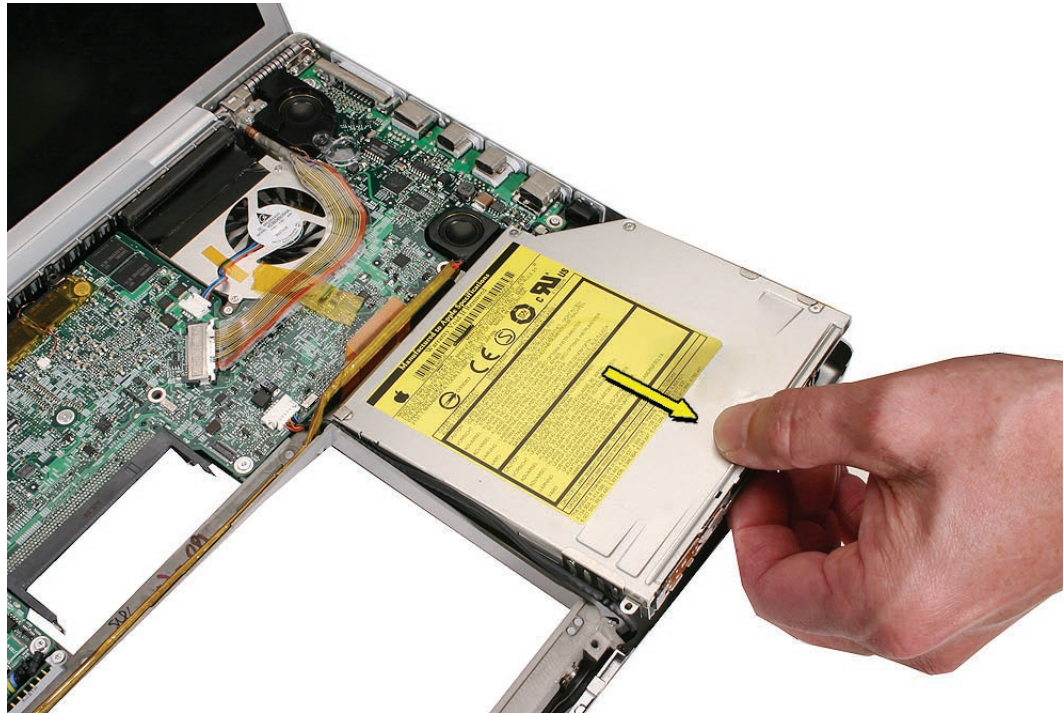

4. If replacing the drive, transfer three brackets, the flex cable, and one EMI gasket (or install new) to the replacement drive.

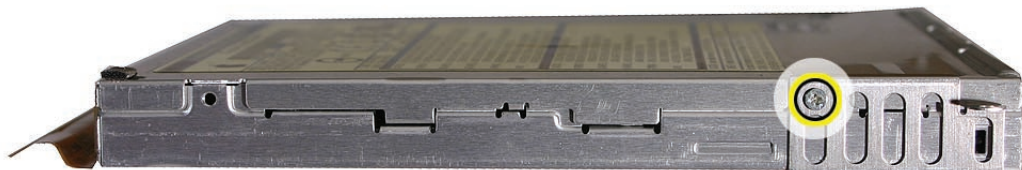

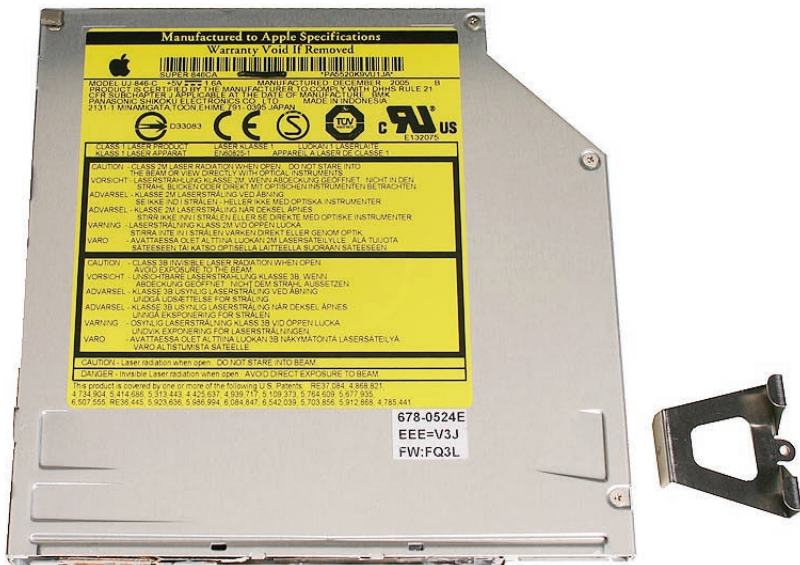
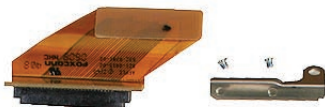

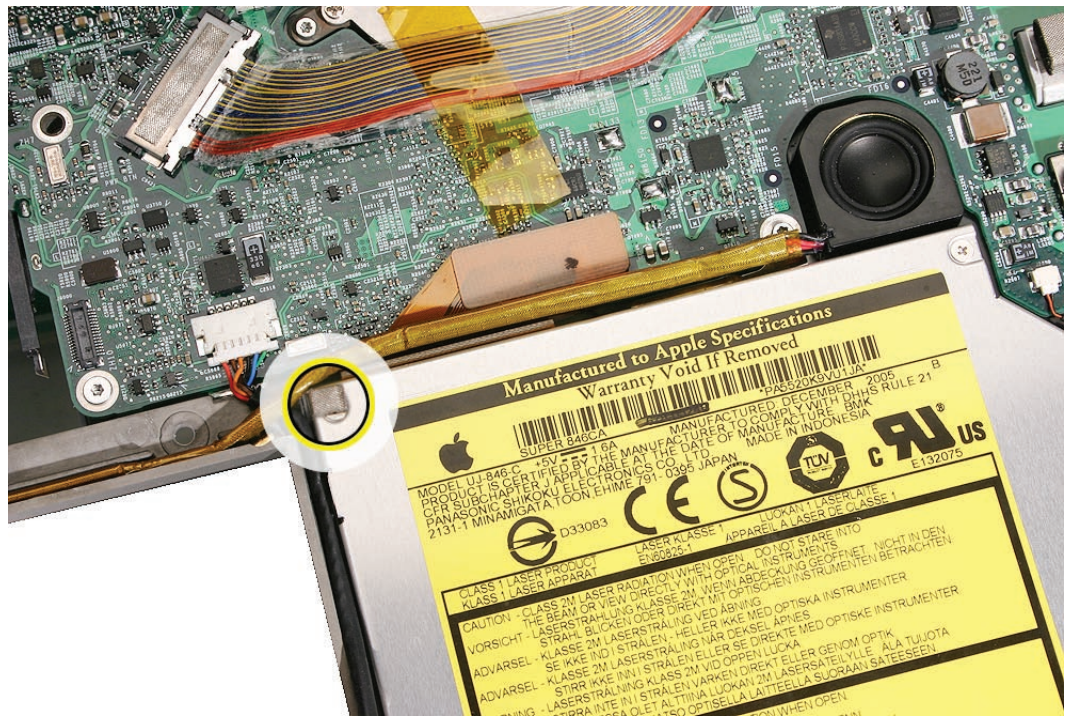

## Replacement Procedure

1. Verify that the EMI gasket is installed on the bottom case in the back of the drive bay.
2. **Important:** The optical drive must be installed so that it does not sit on top of the gasket. Insert the drive toward the logic board so that the gasket is pushed behind the drive.

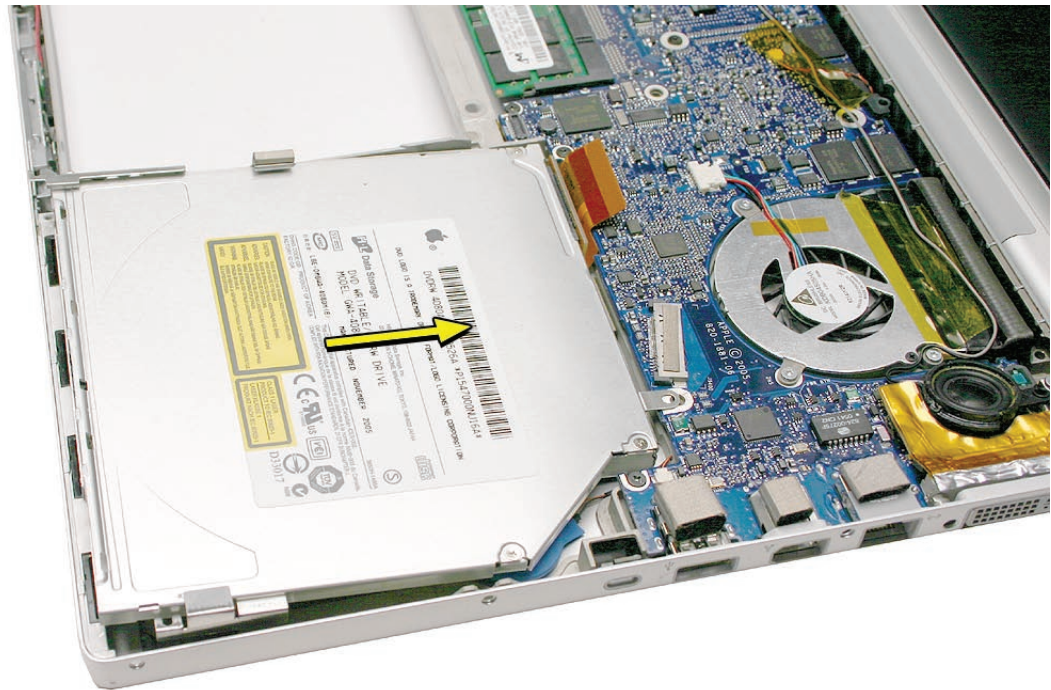
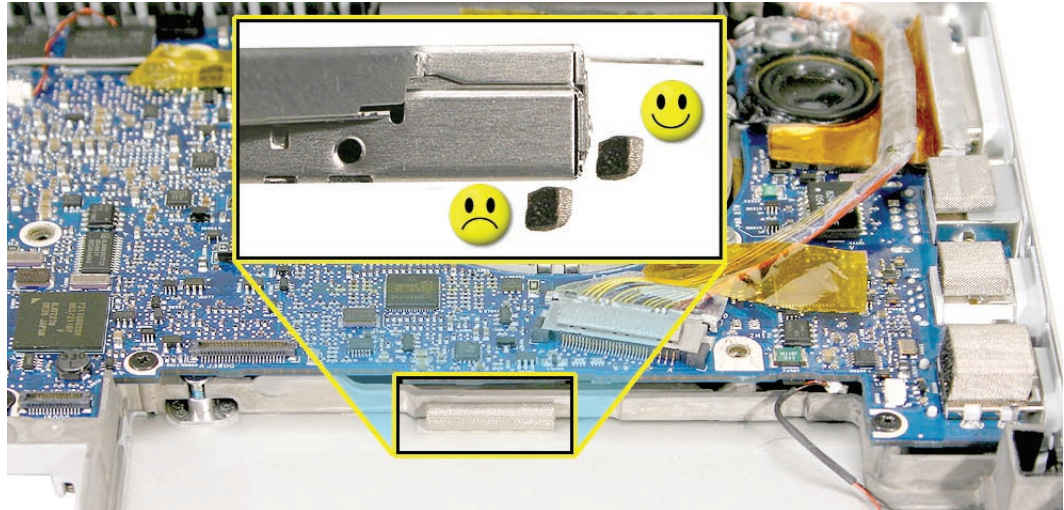



# Backup Battery

## Tools

This procedure requires the following tools:

- Needle-point metal probe
- Black stick (nylon probe 922-5065) or other non-conductive nylon or plastic flat-blade tool

## Preliminary Steps

Before you begin, remove the following:

- [Battery](#)
- [Top Case](#)
- [Optical Drive](#)

## Part Location

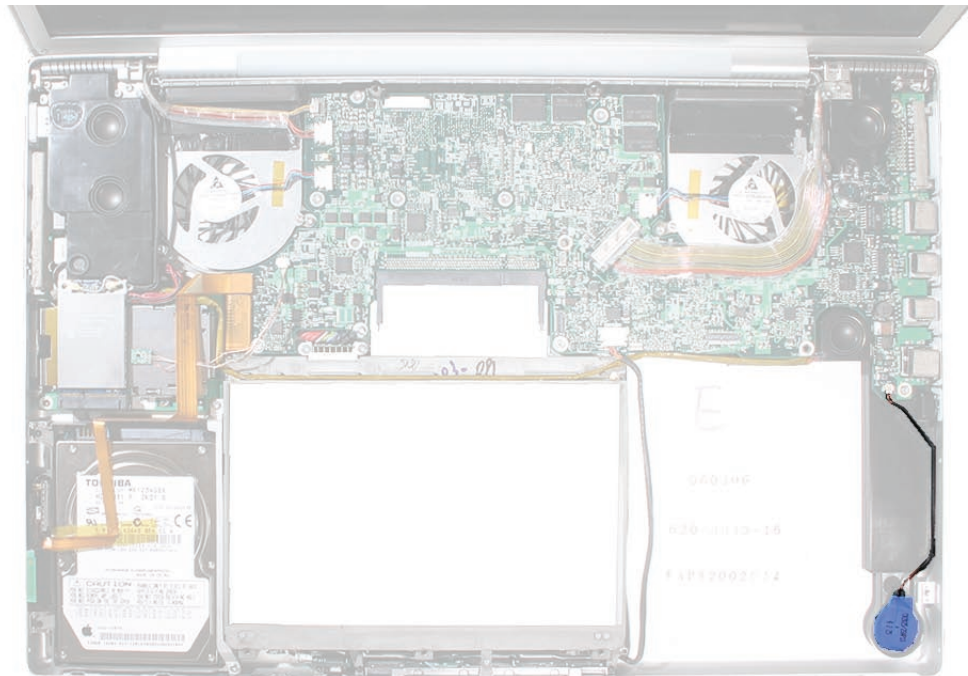

## Procedure

1. (a) For the MacBook Pro (17-inch), use a needlepoint probe to disconnect the cable connector from the logic board, as shown below. **Warning:** When using a needlepoint probe, great care must be used to avoid slipping off the connector and damaging components.

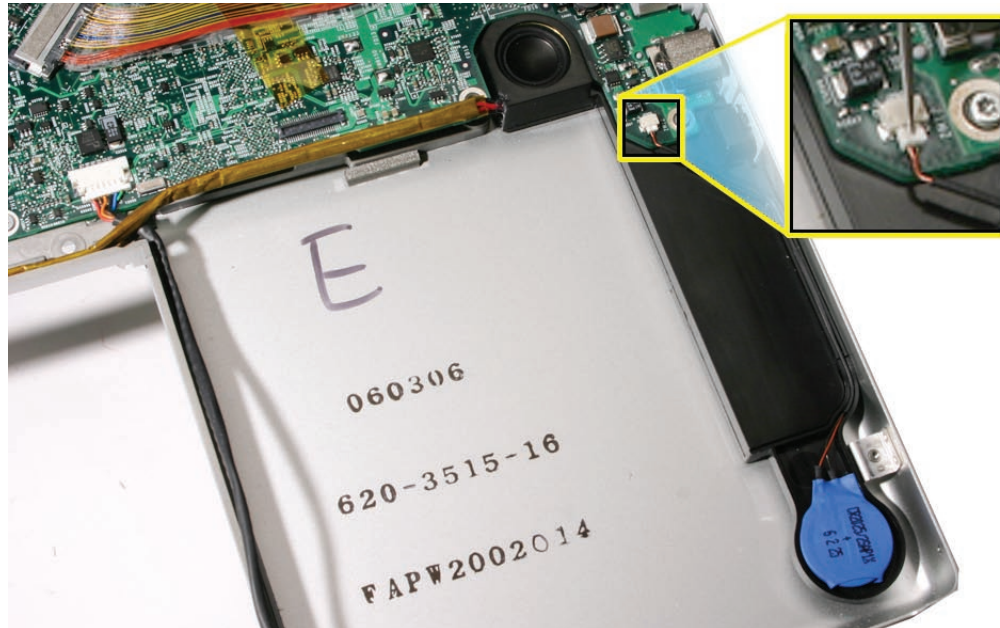

- (b) For the MacBook Pro (17-inch Core 2 Duo), hold the connecting wires as close to the JST connector as possible and gently pull it straight up and out of its well..

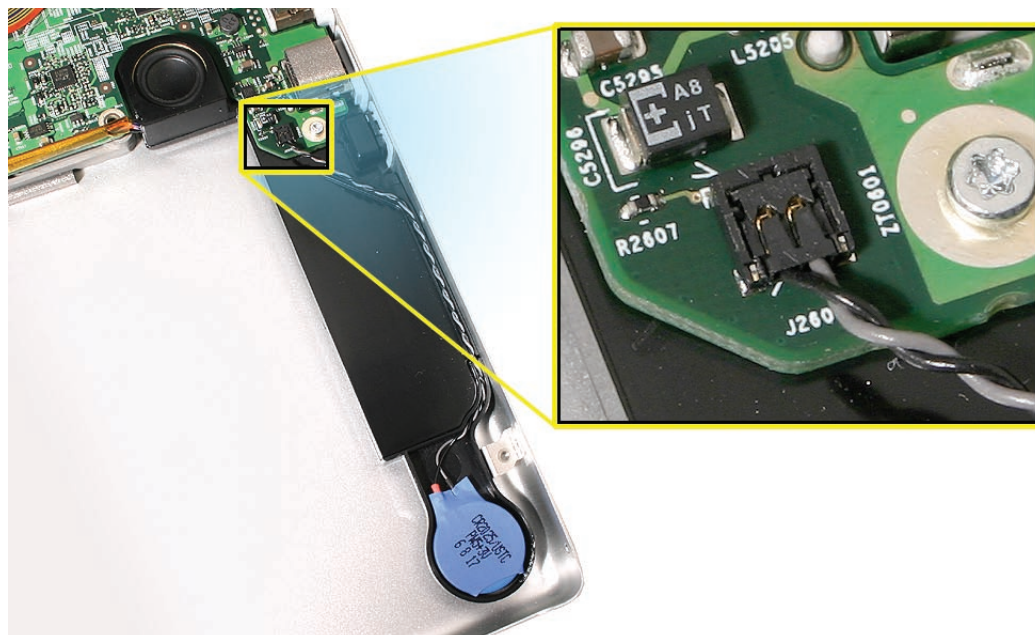

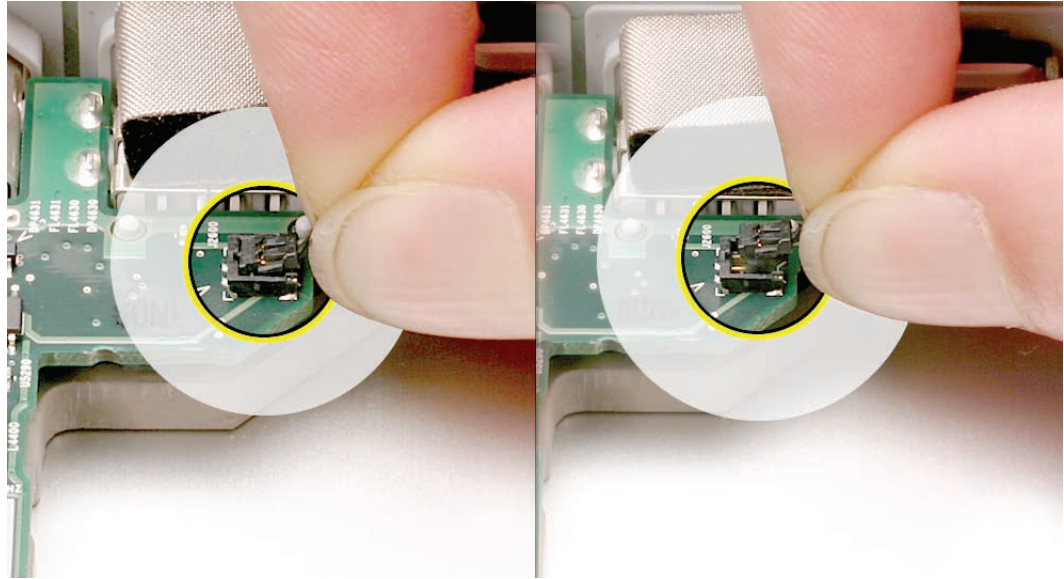

2. Pry up the backup battery from the well in the right speaker.



3. To install a replacement backup battery, remove the adhesive protector and press the battery into place in the same well that it was removed from the right speaker.
4. Guide its cable into the channel along the right speaker.

- 
5. Connect the cable to the logic board.

**Note 1:** The MacBook Pro (17-inch) connector is keyed to install only one way.

**Note 2:** The MacBook Pro (17-inch Core 2 Duo) JST connector can be reconnected using either your finger or a black stick.

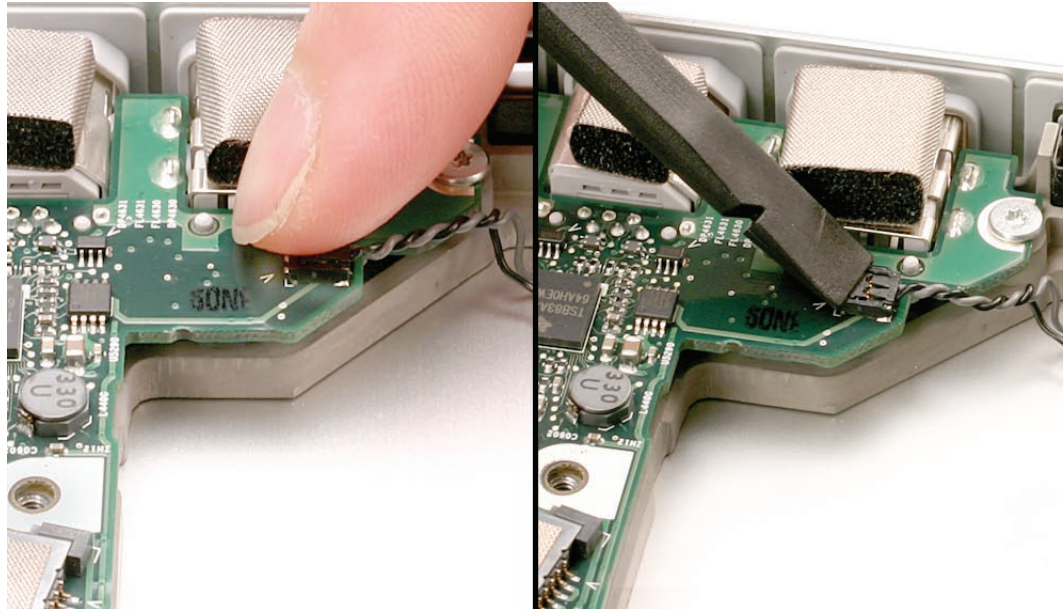

Given a very keen eye, one way to distinguish right side up of a JST connector is by looking for the word 'push' on the top side of each connector, as shown below.







# Ambient Light Sensors

## Tools

This procedure requires the following tools:

- Torx T6 screwdriver (magnetized)

## Preliminary Steps

Before you begin, remove the following:

- [Battery](#)
- [Top Case](#)

## Part Location

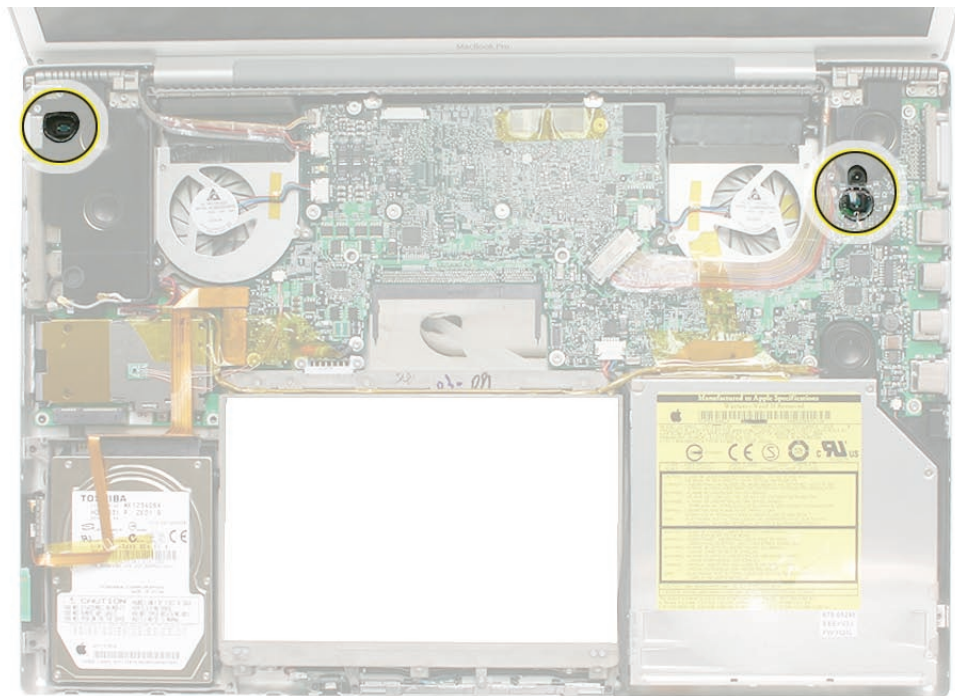

## Procedure

The **right ambient light sensor** is part of the logic board and is not separately replaceable, but has a removable dust cover that attaches with a small screw to the right speaker.

The **left ambient light sensor** is part of the left I/O board and is not separately replaceable, and has a dust cover glued onto the left speaker that is also not separately replaceable.

To remove the right sensor's dust cover:

1. Remove the Torx T6 screw shown.

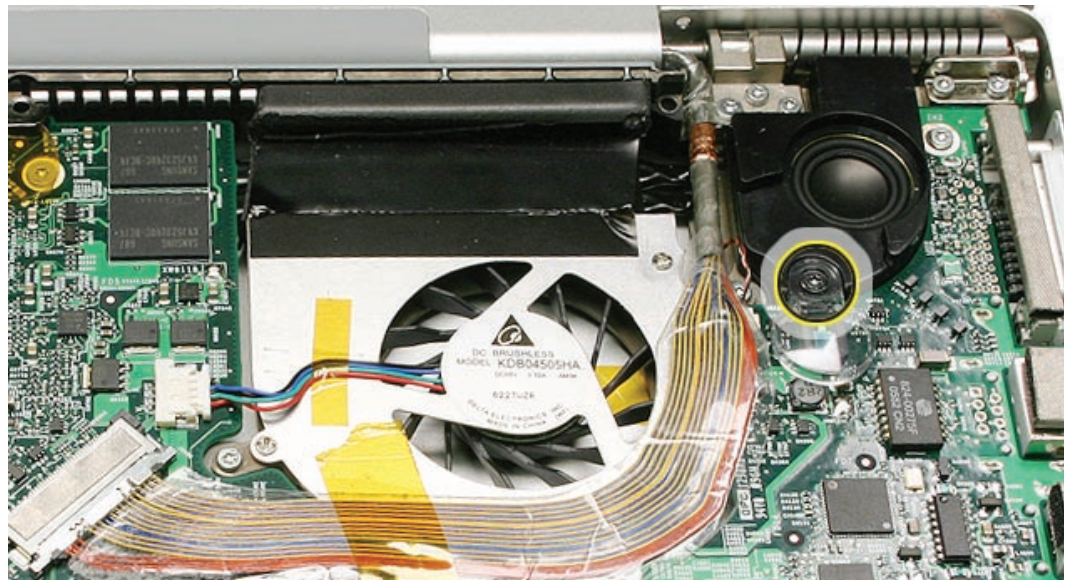



# Speakers and Microphone

The right and left speakers are two separately replaceable parts.

The left speaker also contains a separately replaceable microphone.

## Tools

This procedure requires the following tools:

- Torx T6 screwdriver (magnetized)
- Black stick (nylon probe 922-5065) or other non-conductive nylon or plastic flat-blade tool
- Kapton tape (922-1731) (0.5-inch x 12-yard roll)

## Preliminary Steps

Before you begin, remove the following:

- [Battery](#)
- [Top Case](#)
- [AirPort Extreme Card](#) (for left speaker)
- [Logic Board](#) (for right speaker)

## Part Location

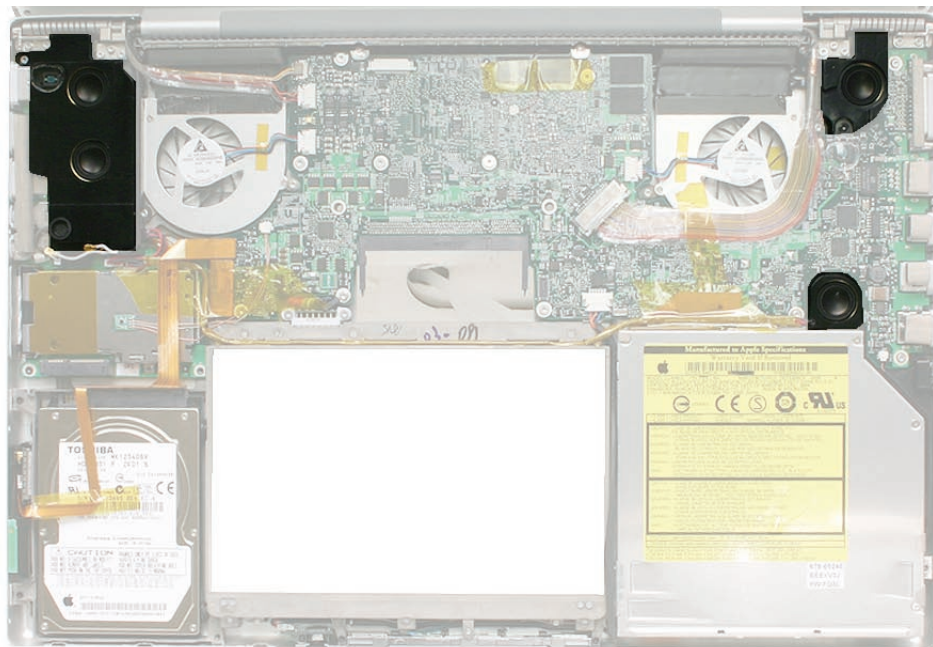

## Procedure

To remove the microphone:

**Note:** The microphone does NOT have to be removed from the left speaker if not replacing the microphone or speaker.

1. Use the flat end of a black stick to pry the microphone boot out of its well in the left speaker.

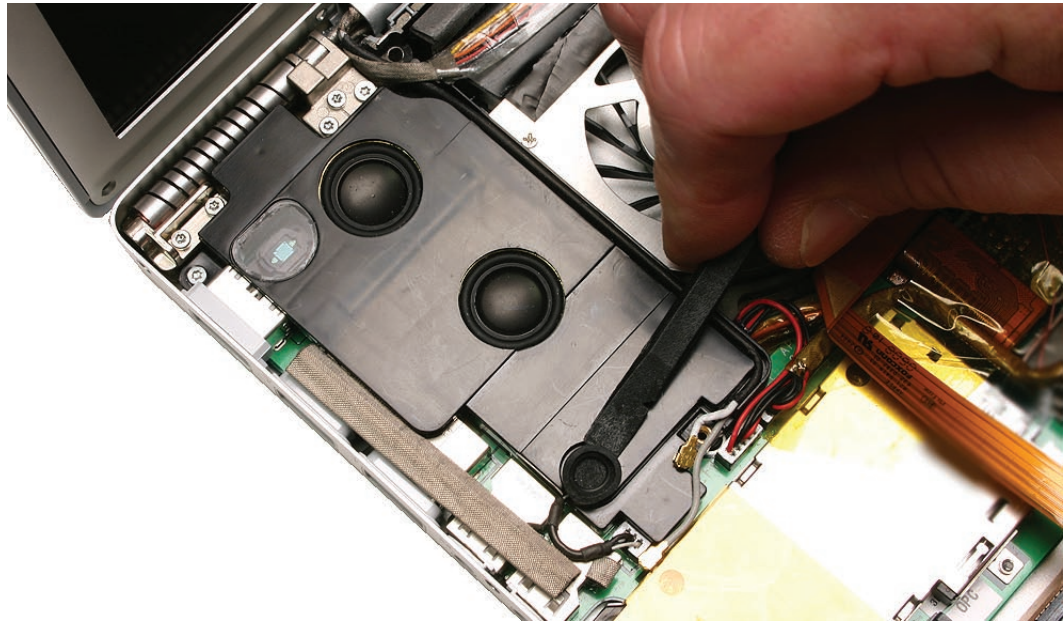

2. Disconnect its connector from the left I/O board.

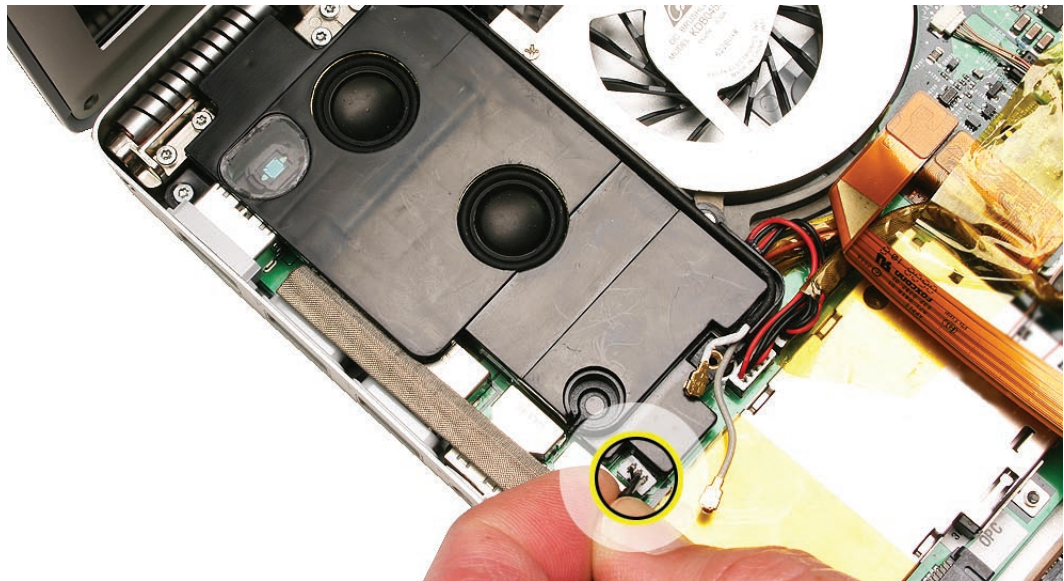

To remove the left speaker:

1. Lift the antenna wires out of the channel along the right side of the speaker.

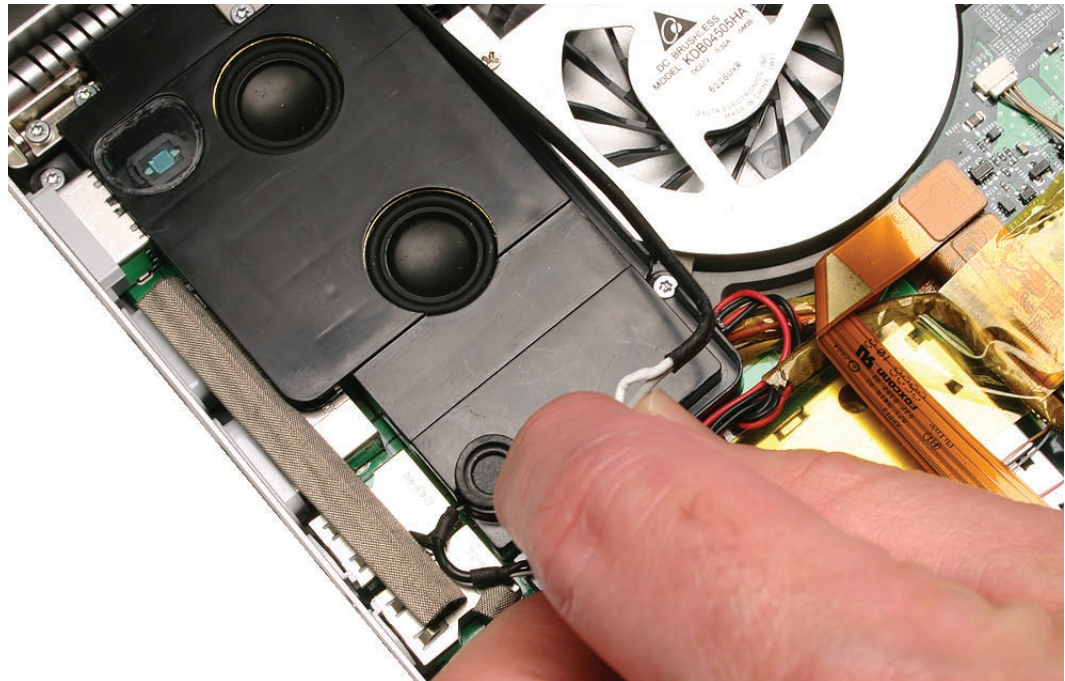

2. Remove two screws.

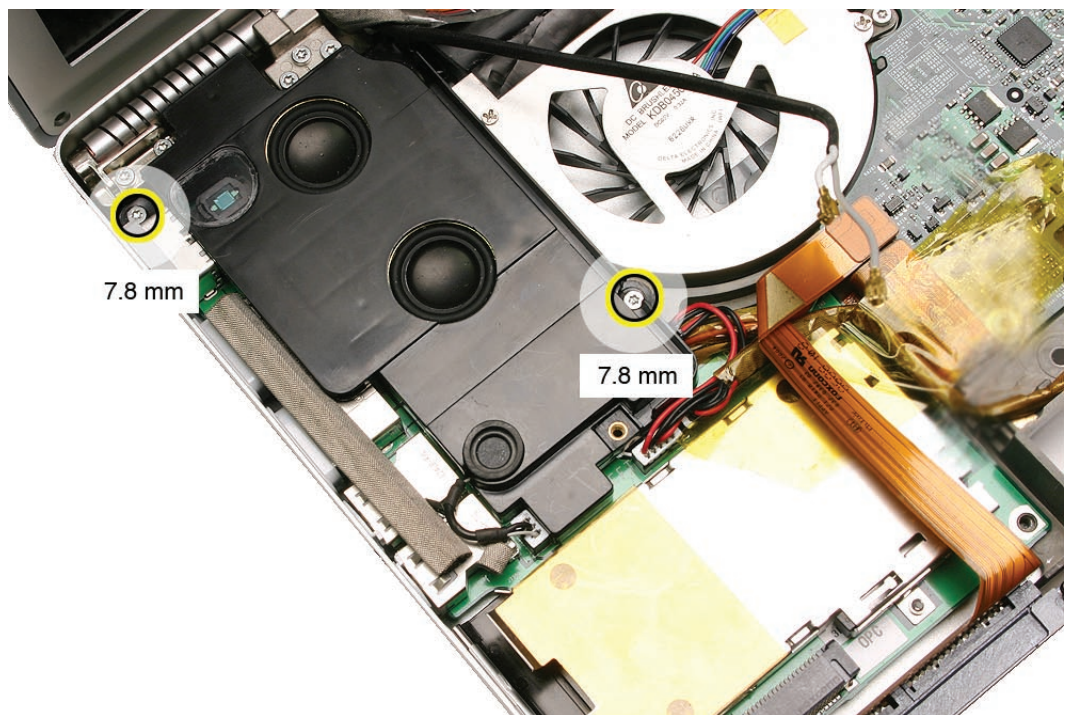

3. Disconnect the speaker cable and the microphone cable, and lift out the speaker.

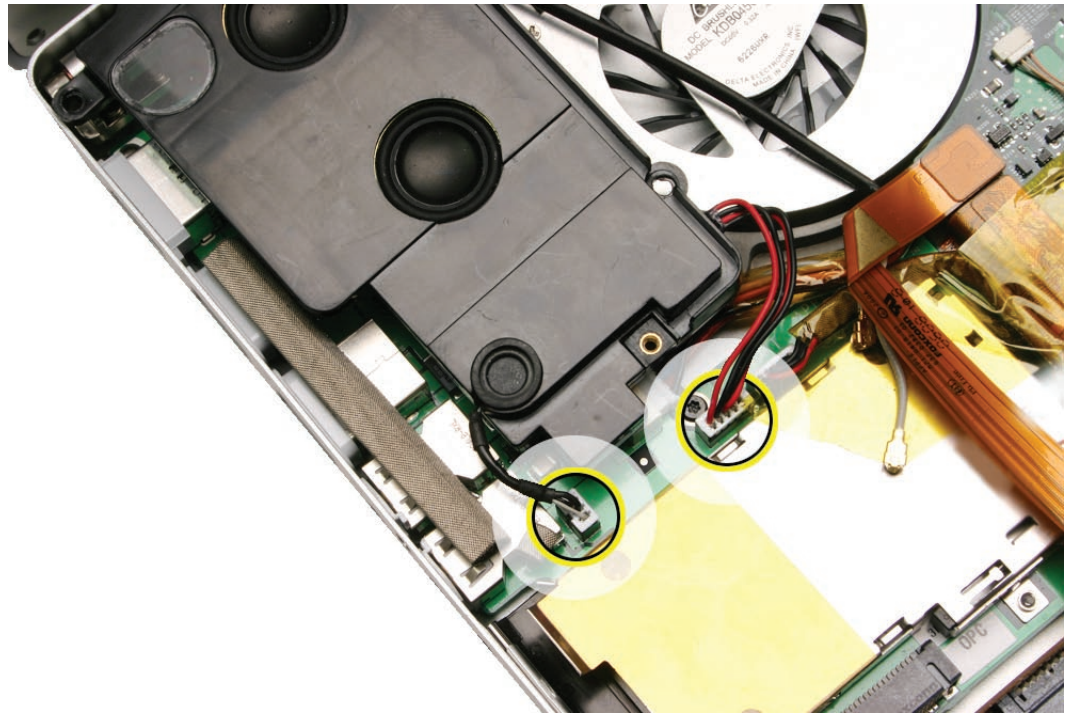

**Replacement Notes:**

- Verify that the antenna cables lay flat within the channel along the edge of the speaker.

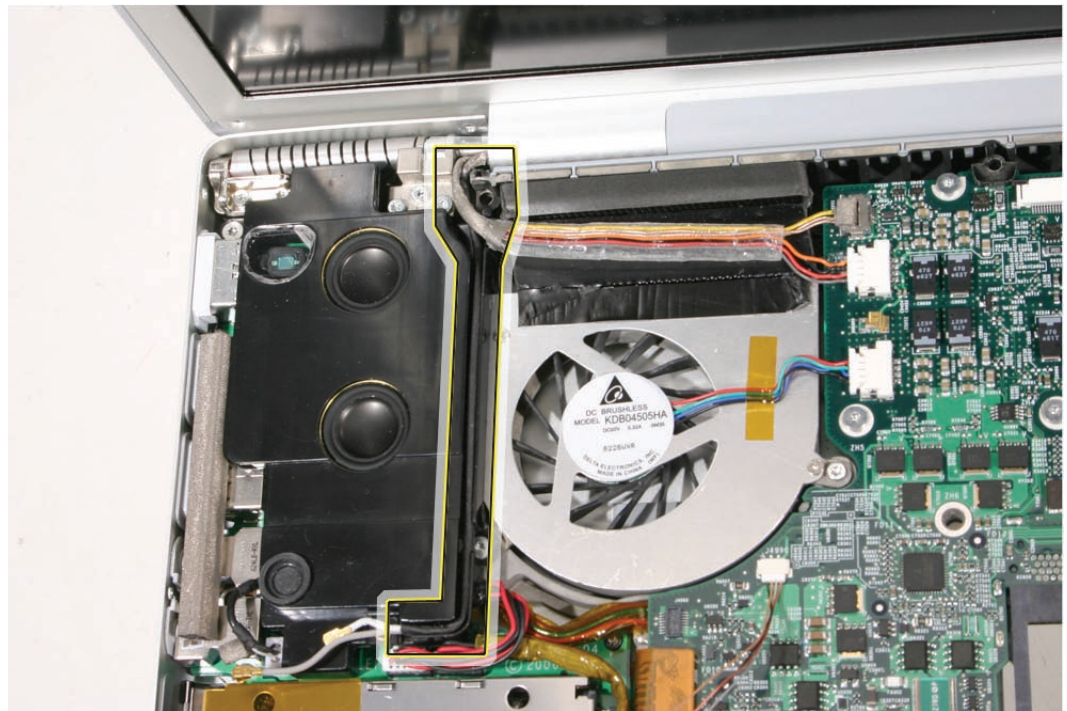

- If not, use Kapton tape to secure, as shown.

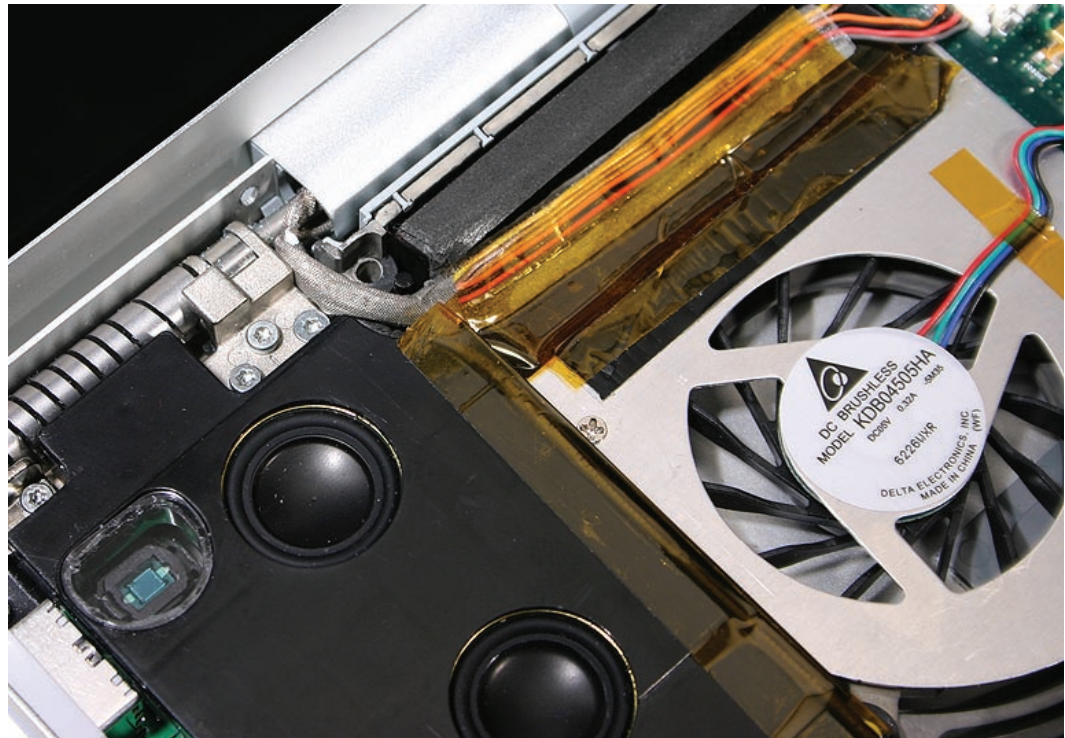

- And verify that the cables for the antennas, and camera and inverter, route to the left of the pin and screw hole at the top right corner of the speaker.

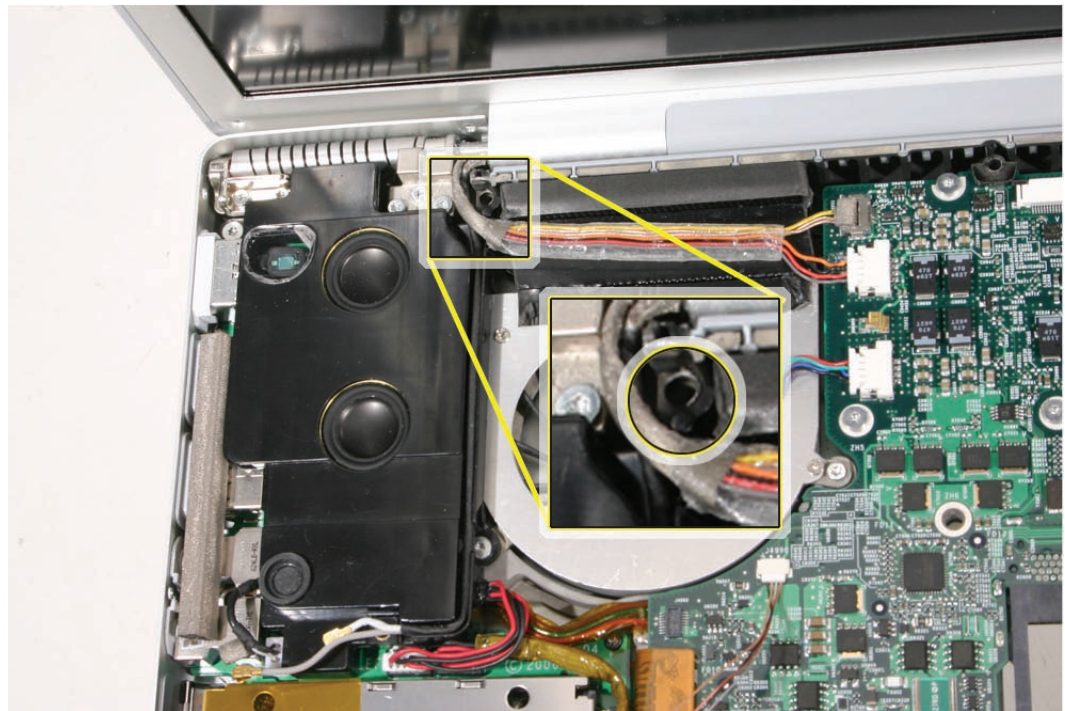

To remove the right speaker:

1. Once the logic board is removed, lift out the right speaker, guide its cable out of the channel above the battery well, and disconnect its connector from the left I/O board.

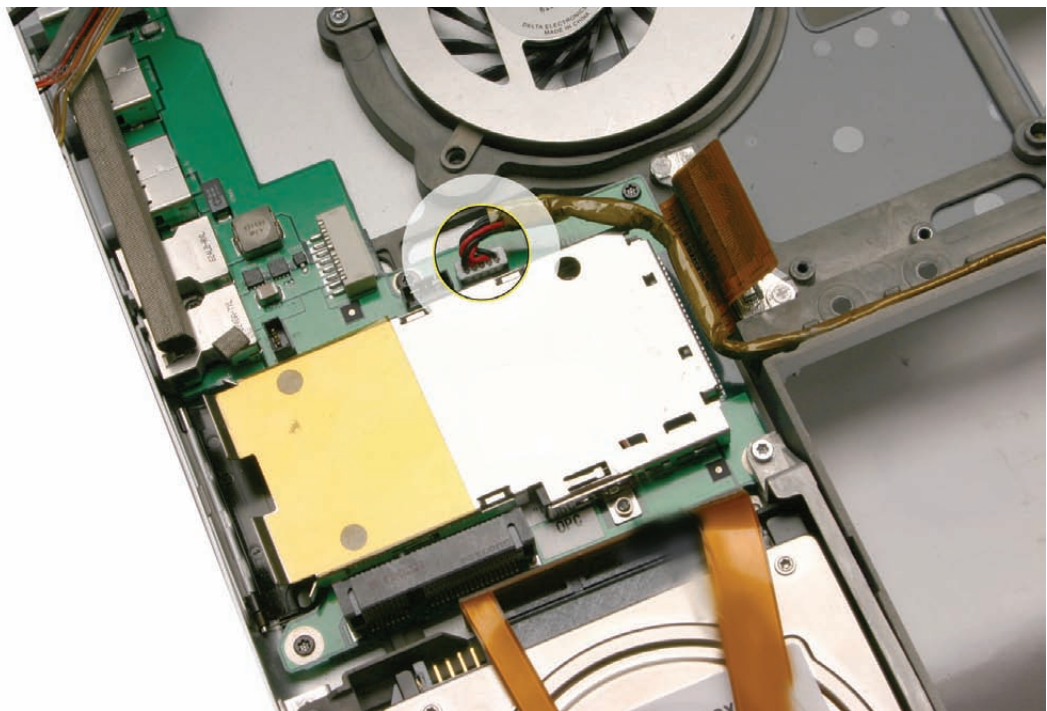
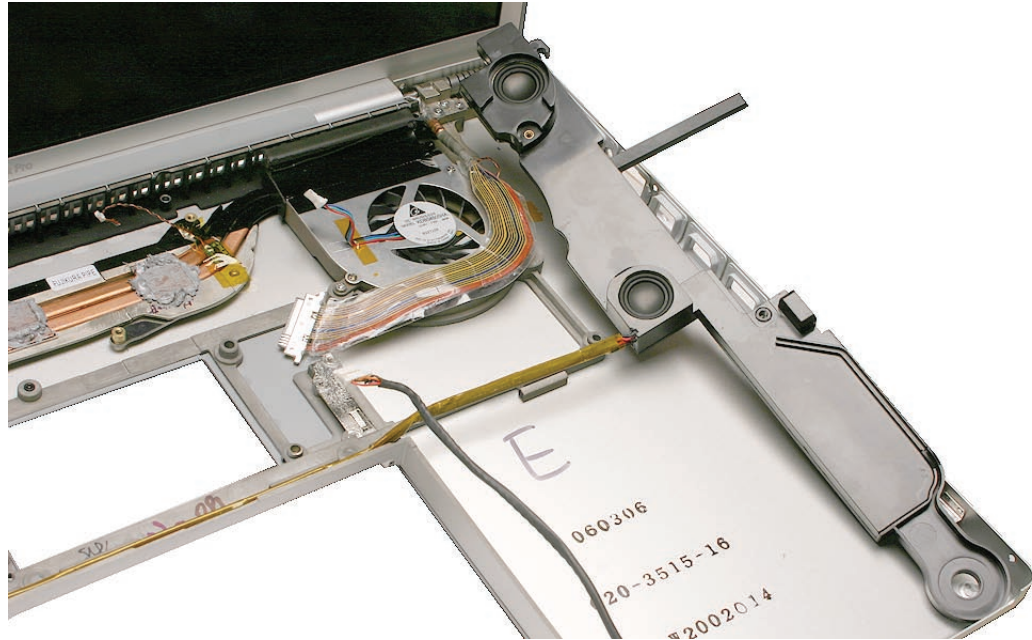





## Left I/O Board

### Tools

This procedure requires the following tools:

- Torx T6 screwdriver (magnetized)
- #0 Phillips screwdriver (magnetized)
- Black stick (nylon probe 922-5065) or other non-conductive nylon or plastic flat-blade tool

### Preliminary Steps

Before you begin, remove the following:

- [Battery](#)
- [Top Case](#)
- [AirPort Extreme Card](#)
- [Left Speaker](#)

### Part Location

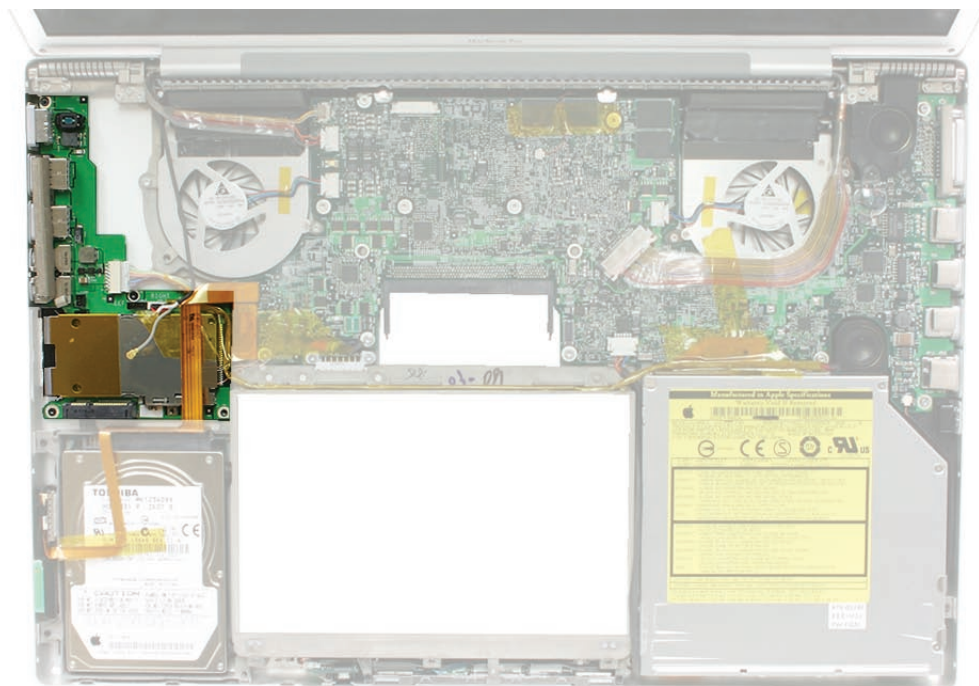

## Procedure

1. Disconnect the hard drive and ExpressCard flex cables, as shown below.

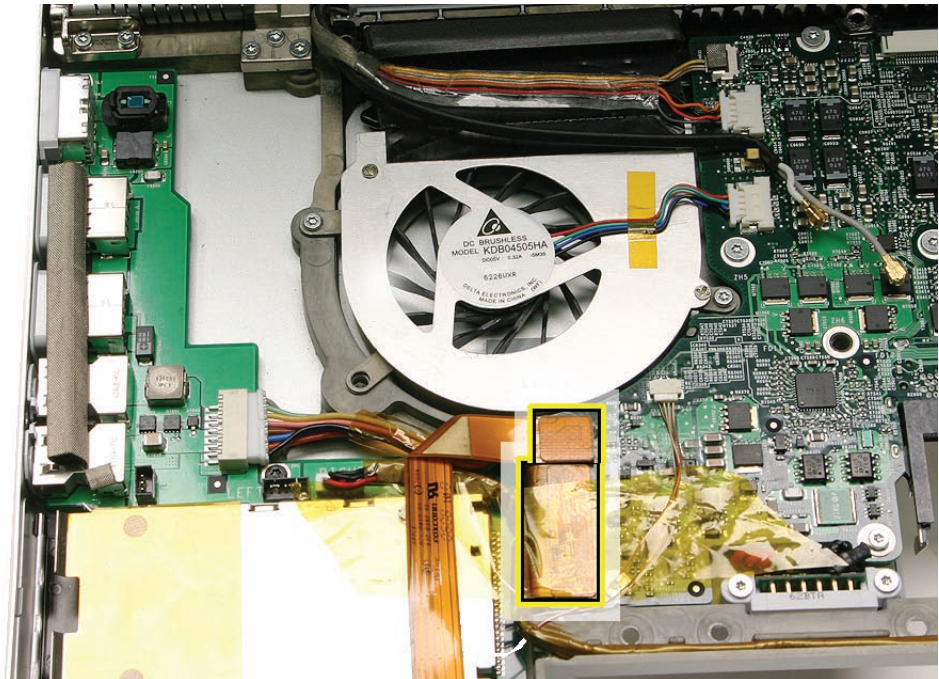

(b) In the MacBook Pro (17-inch Core 2 Duo), the connectors will be the [JST](#) type.

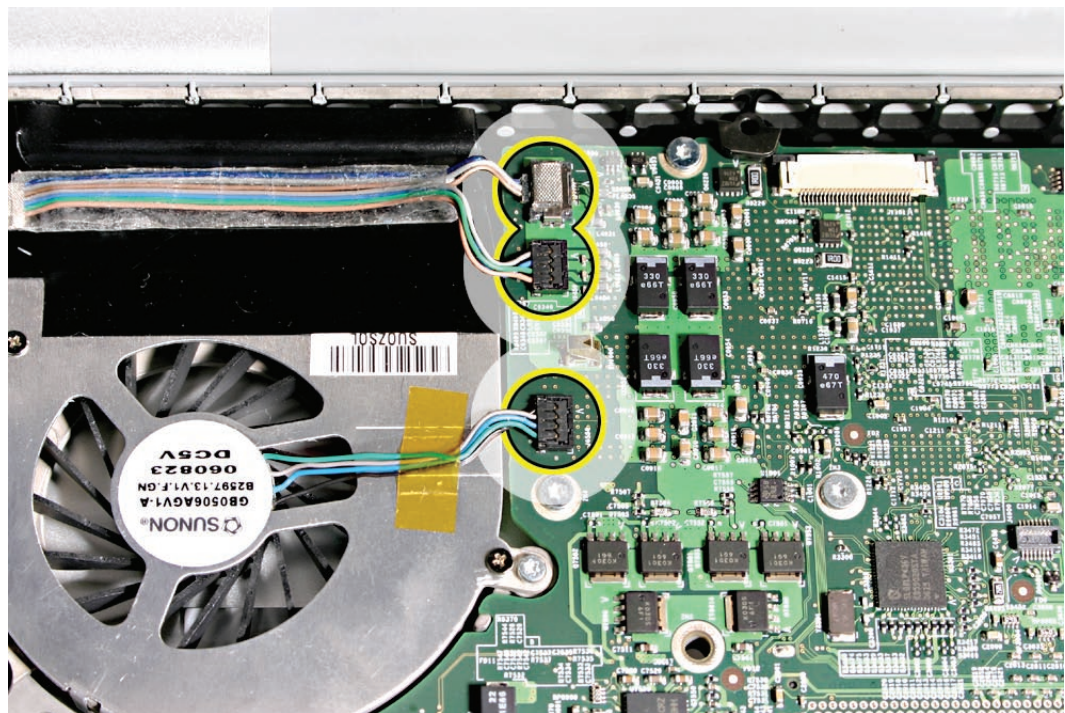

2. Disconnect the left I/O cable and right speaker cable.

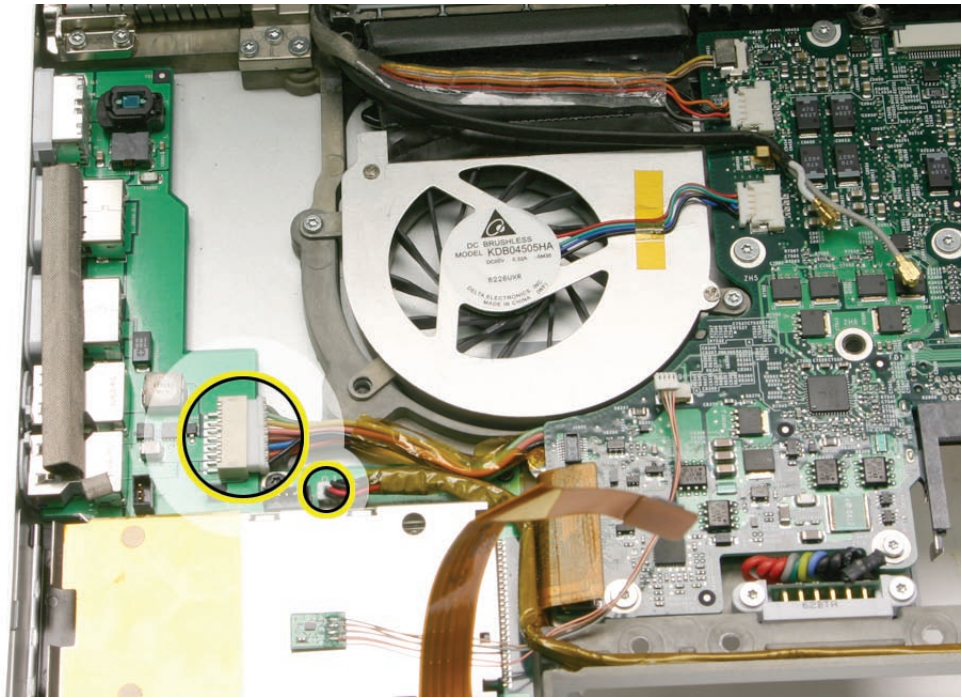

3. Remove the four Torx T6 screws.

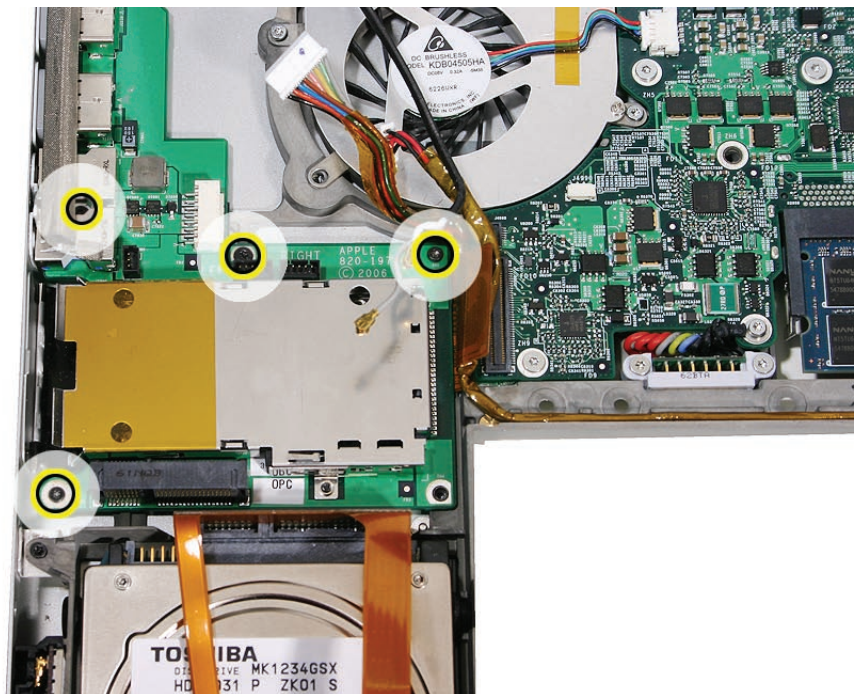

5. Lift slightly and slide the left I/O board assembly away from the port openings to remove.



6. The ExpressCard cage assembly is attached to the left I/O board. Peel back the Mylar and remove the four screws.

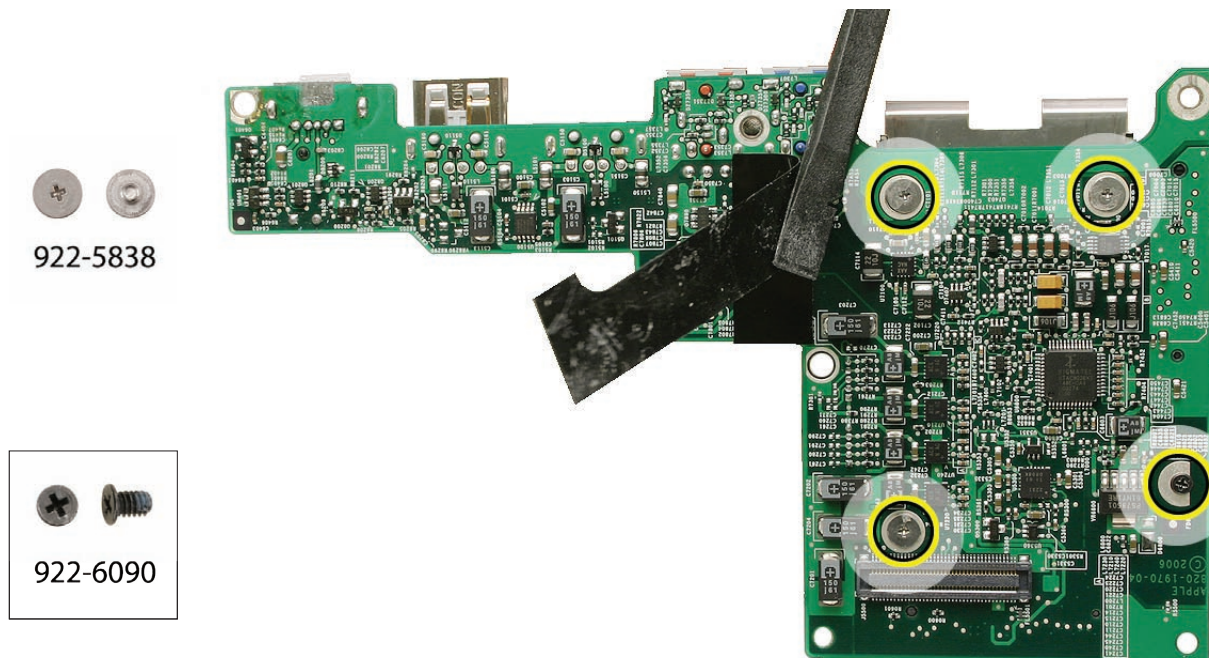

7. Lift off the card cage.

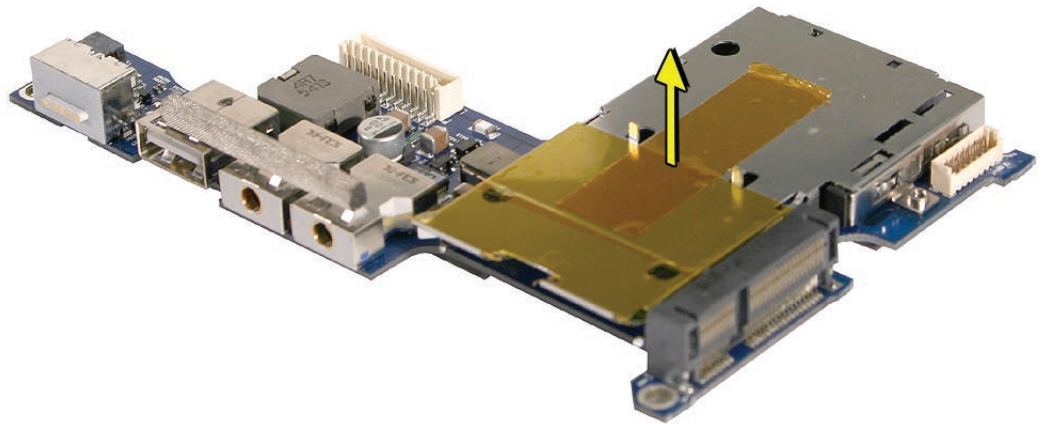

**Replacement Notes:**

- Install the two EMI gaskets.

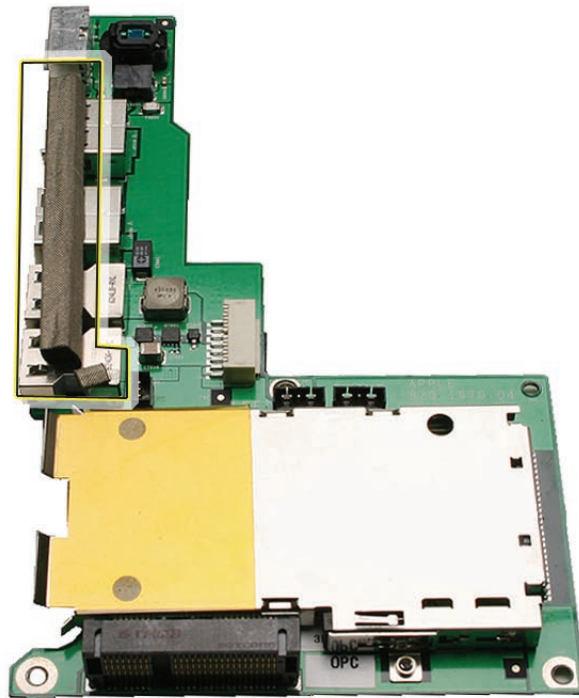

- Install the flex cable in the orientation shown.

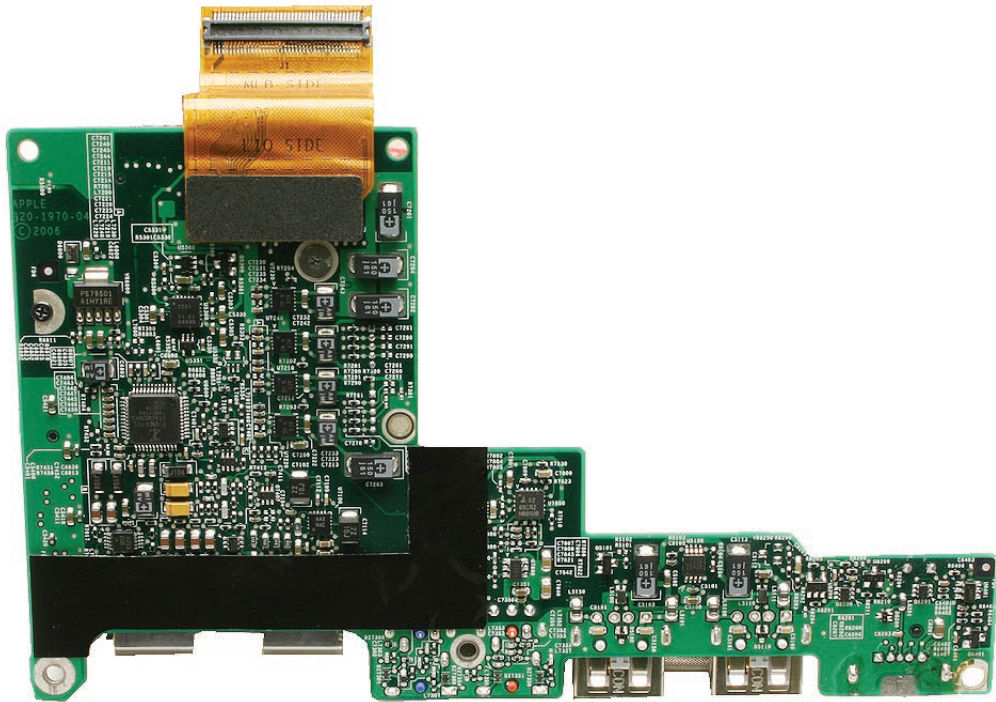

- When the board is in place and the ports are seated, hold the power adapter port tightly against the port opening while installing screws.

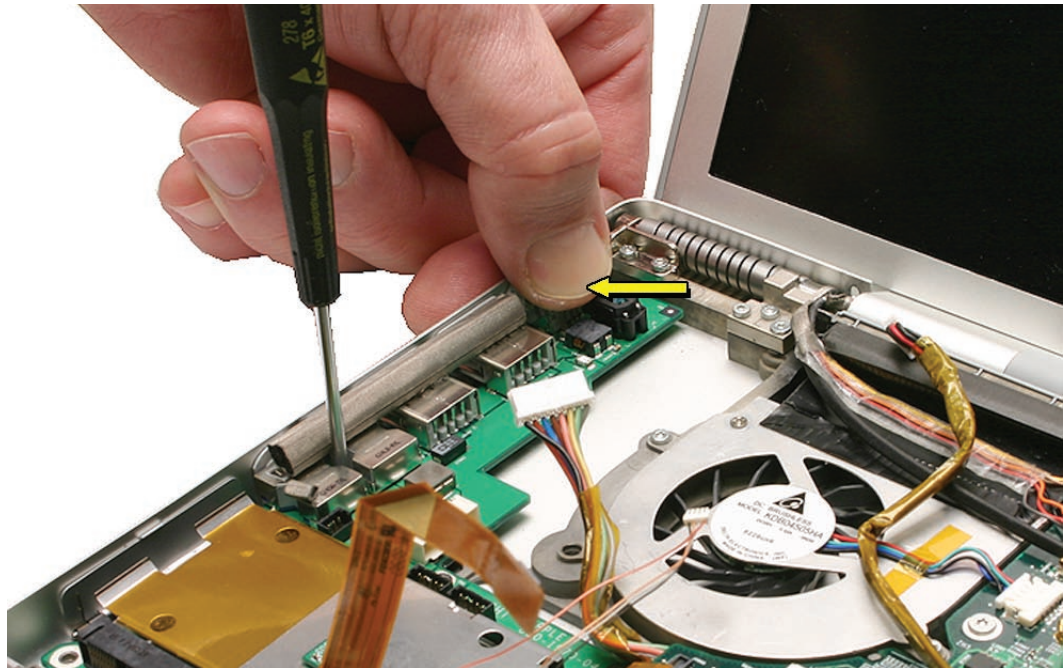

- After securing the board, exercise the ExpressCard slot door to verify clearance.



# ExpressCard Cage

## Tools

This procedure requires the following tools:

- #0 Phillips screwdriver (magnetized)

## Preliminary Steps

Before you begin, remove the following:

- [Battery](#)
- [Top Case](#)
- [AirPort Extreme Card](#)
- [Left Speaker](#)
- [Left I/O Board](#)

## Part Location

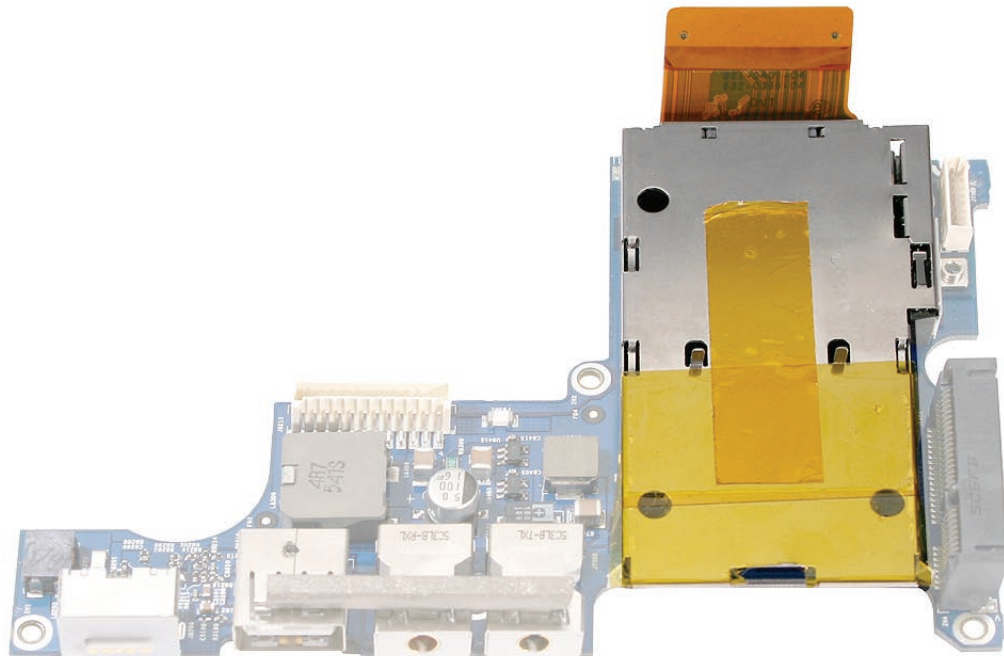

## Procedure

See the [Left I/O Board](#) chapter for removal of the ExpressCard cage.



# Fans

## Tools

This procedure requires the following tools:

- Torx T6 screwdriver (magnetized)
- Black stick (nylon probe 922-5065) or other non-conductive nylon or plastic flat-blade tool
- Razor knife
- Kapton tape (922-1731) (0.5-inch x 12-yard roll)

## Preliminary Steps

Before you begin, remove the following:

- [Battery](#)
- [Top Case](#)
- [Left Speaker](#) (left fan)

## Part Location

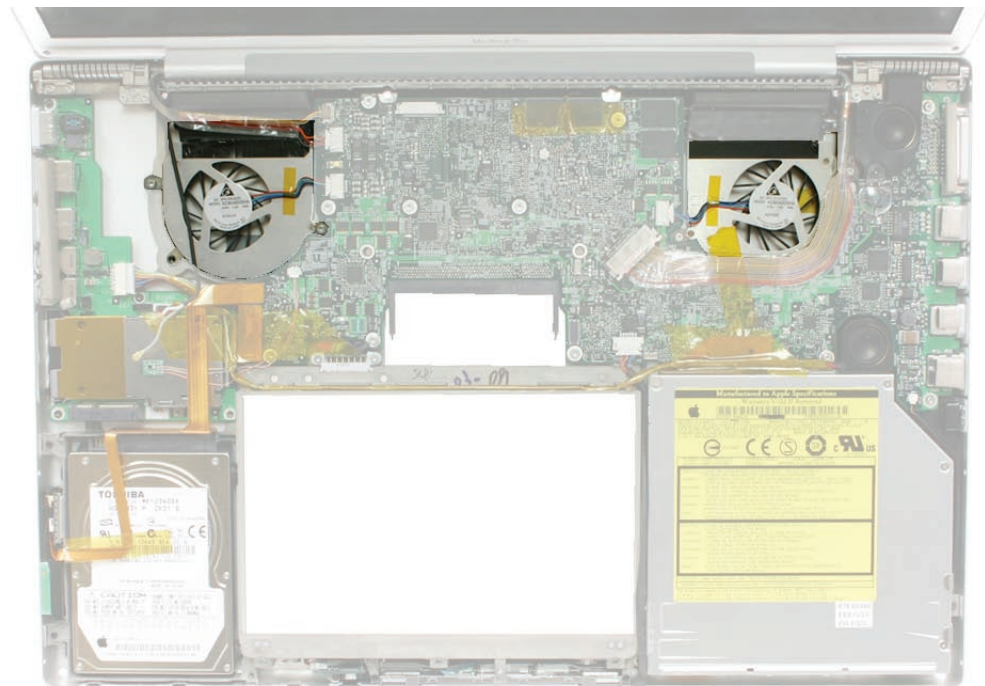



## Procedure

To remove the left fan:

1. Disconnect the three connectors [JST connectors on the MacBook Pro (17-inch Core 2 Duo)], then carefully peel up the inverter/camera cable bundle and move safely out of the way.  
**Note:** Use care to try not to dislodge the EMI gasket on the camera connector (see below).

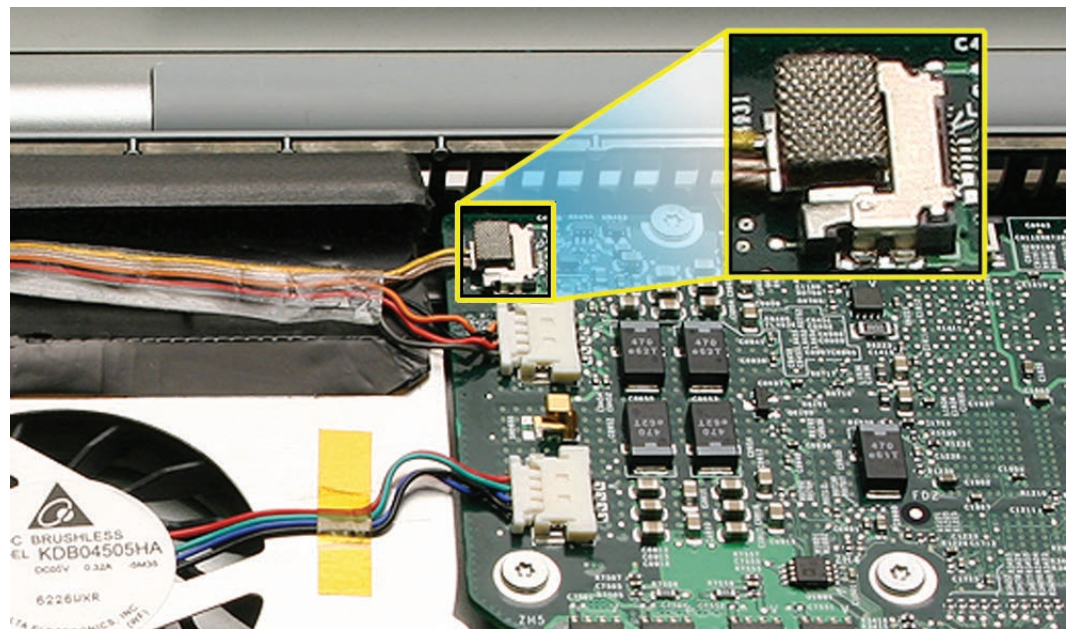
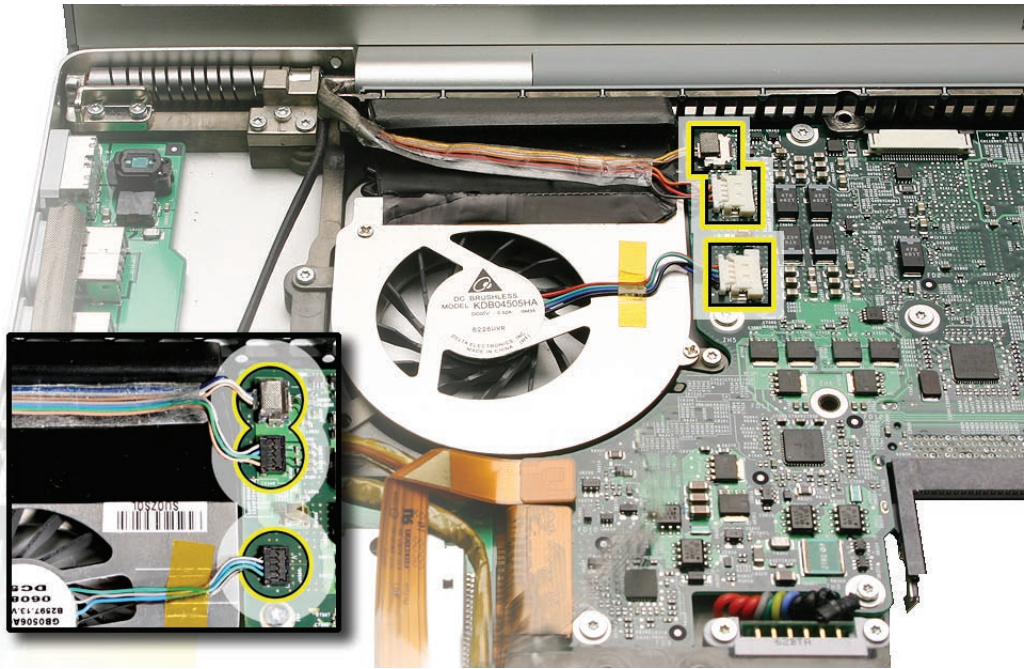

2. With the cables safely out of the way, use a razor knife to cut the length of the tape along the seam between the fan cover and the fins.

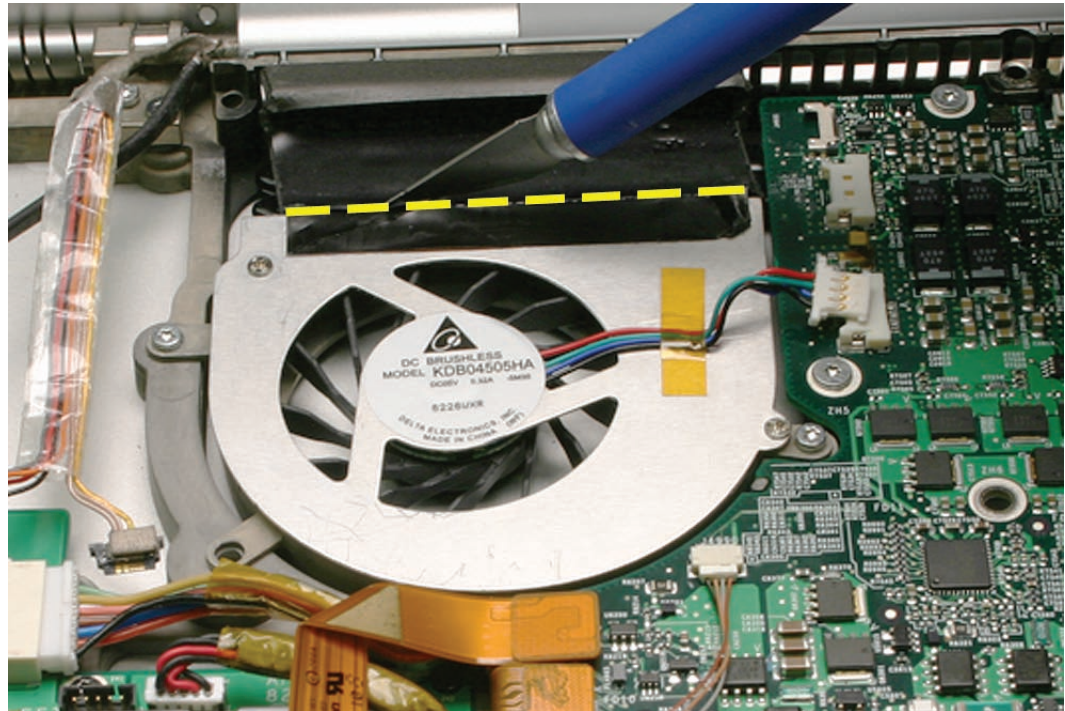

3. Remove two Torx T6 screws.

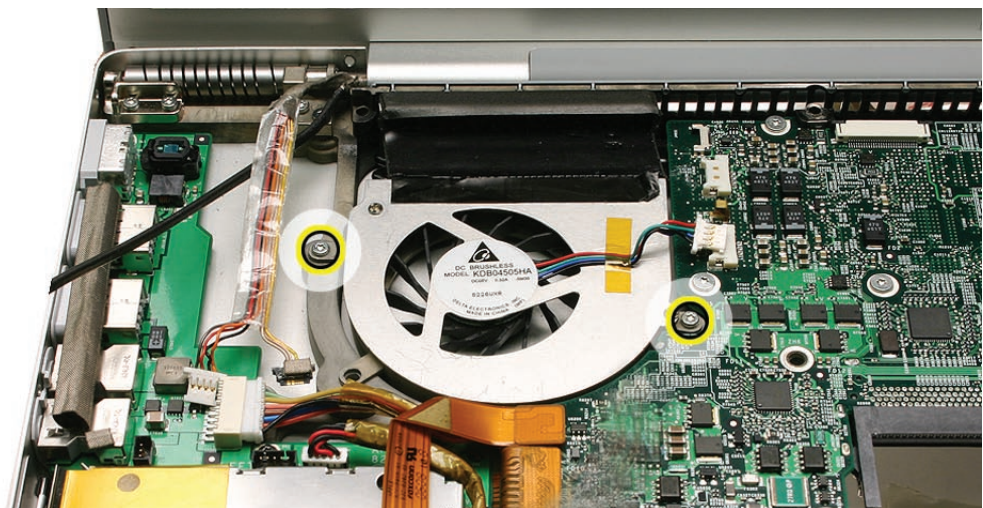

4. Lift the fan out.

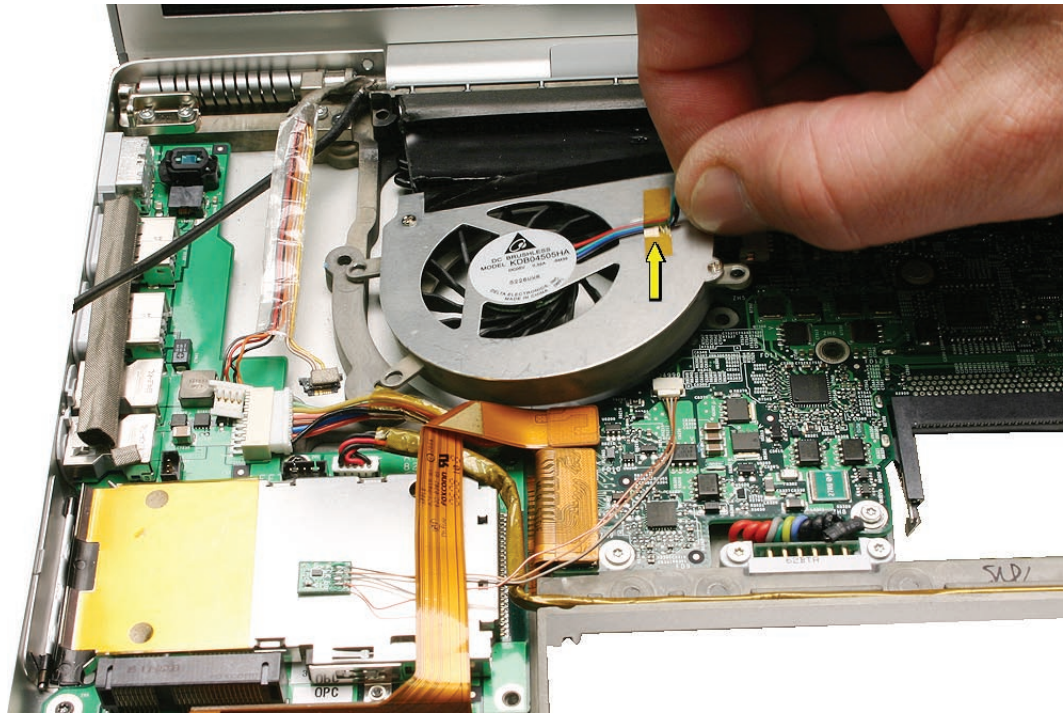

5. **Replacement Note:** Use Kapton tape to reseal the cut tape.

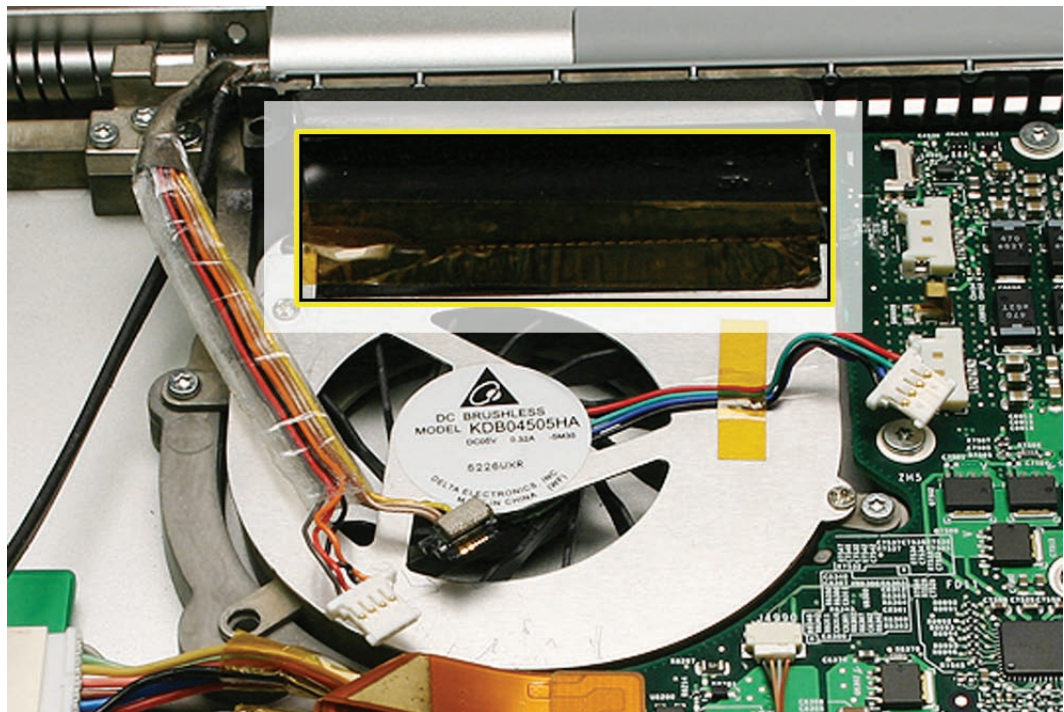

To remove the right fan:

1. Disconnect the LVDS cable and fan connector and move safely out of the way.

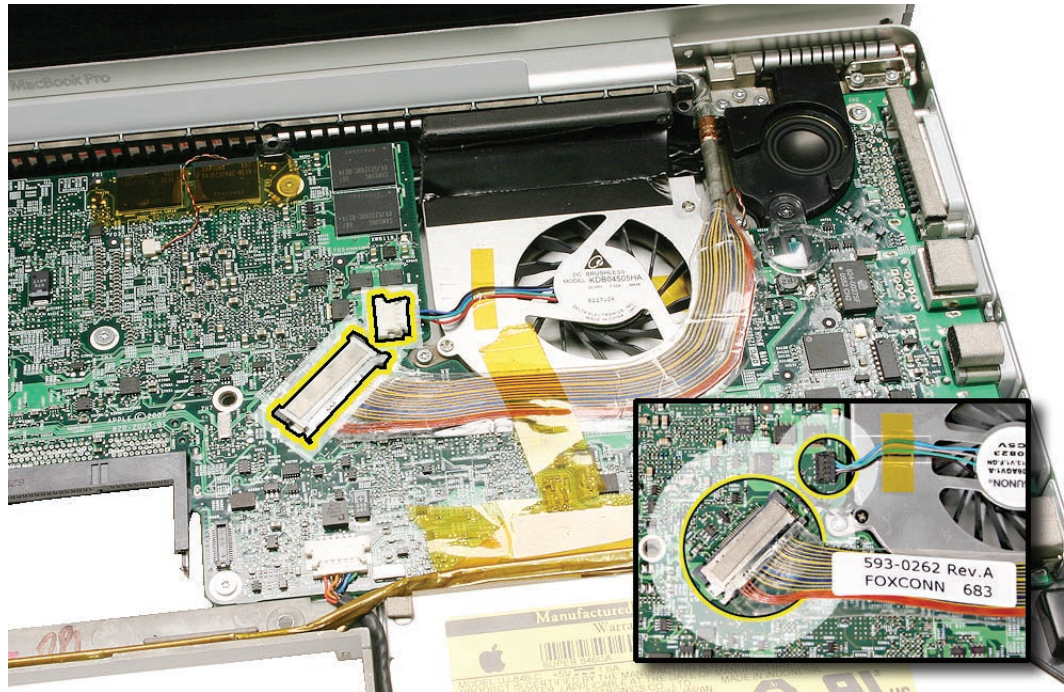

2. Use a razor knife to cut the length of the tape along the seam between fan cover and fins.

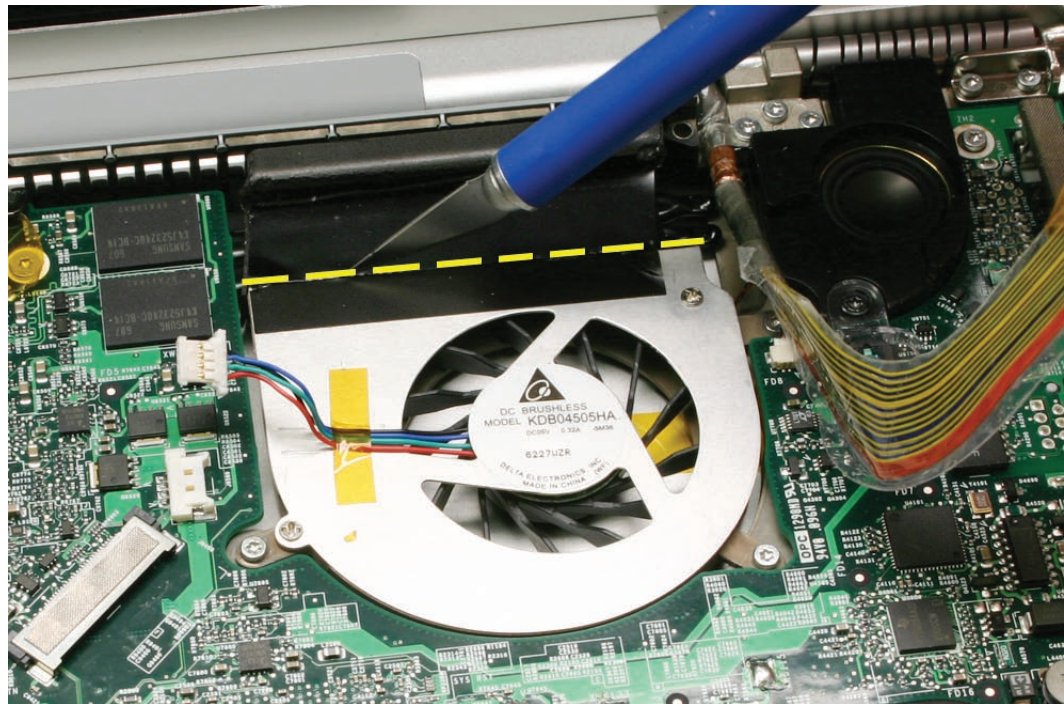

3. Remove three screws and lift the fan out.

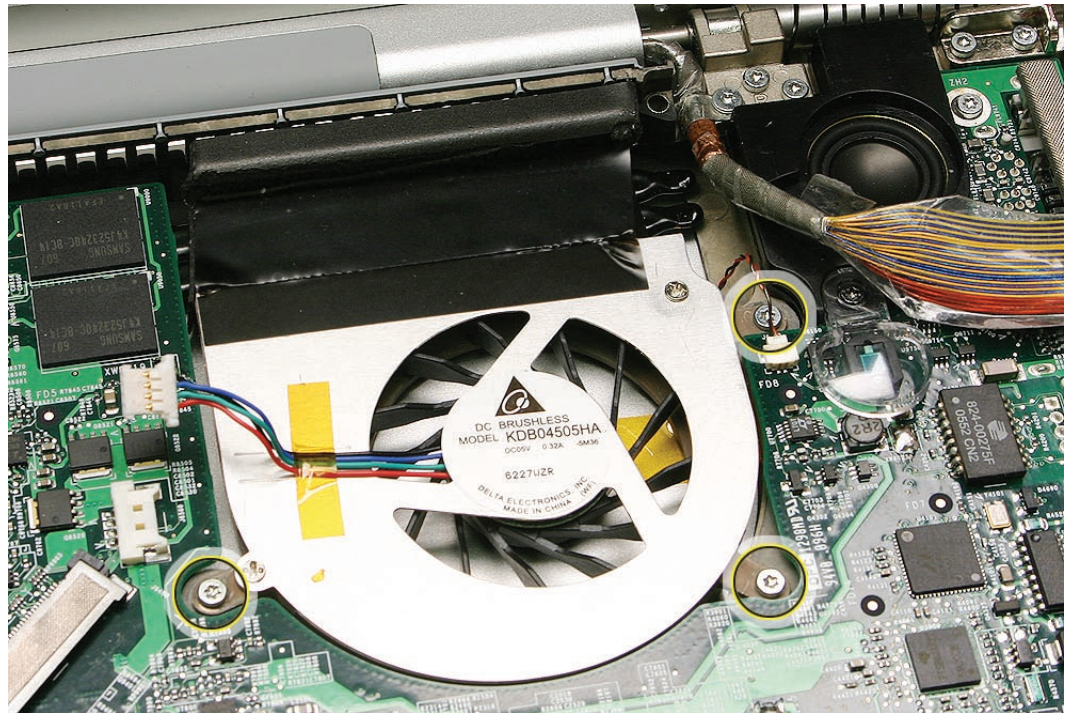

4. **Replacement Note:** Use Kapton tape to reseal the cut tape.

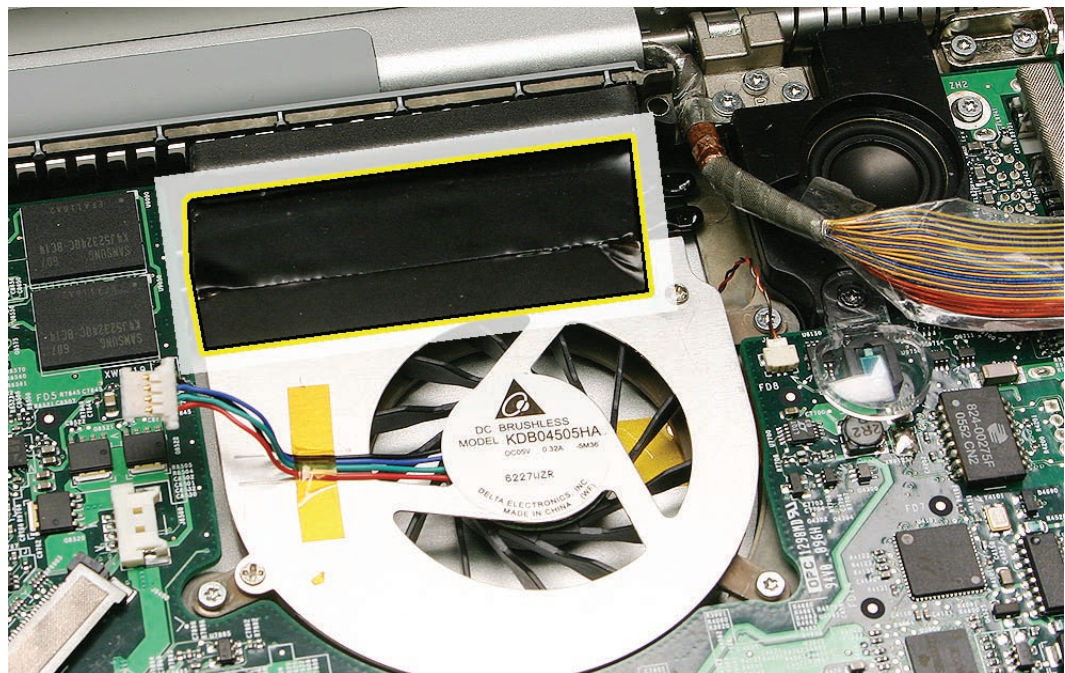



# Logic Board

## Tools

This procedure requires the following tools:

- Torx T6 screwdriver (magnetized)
- Black stick (nylon probe 922-5065) or other non-conductive nylon or plastic flat-blade tool
- Needle-point metal probe
- Multi-compartment screw tray (such as a plastic ice cube tray)
- Kapton tape (922-1731) (0.5-inch x 12-yard roll)
- Thermal grease (922-7144)
- Gasket kit (076-1217)
- Isopropyl alcohol cleaning wipes

## Preliminary Steps

Before you begin, remove the following:

- [Battery](#)
- [Memory](#)
- [Top Case](#)
- [Left Speaker](#)
- [Optical Drive](#)

## Part Location

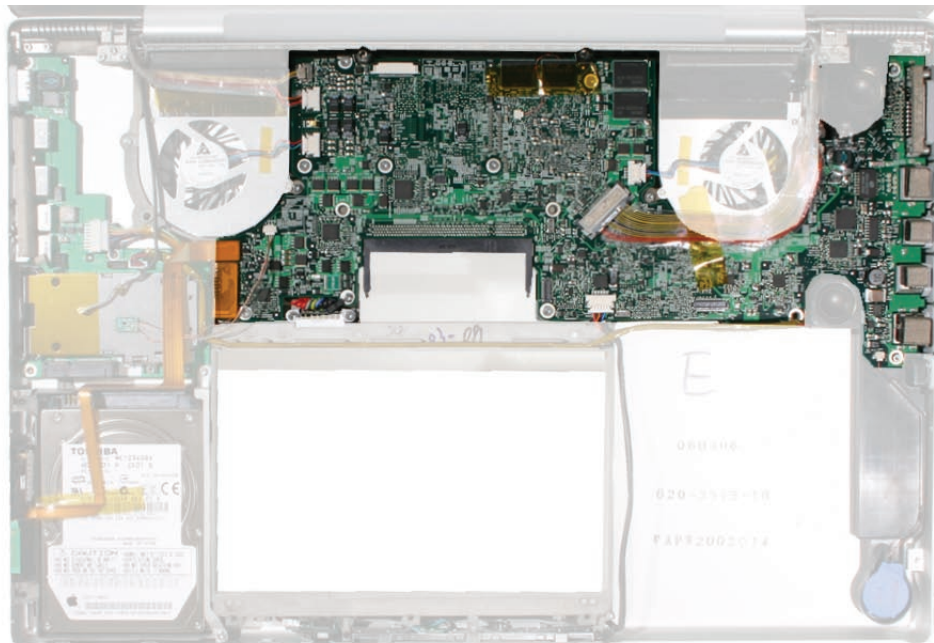

---

## Procedure

There are two ways to remove the logic board:

**Method 1:** Separate the logic board from the heatsink, as usual, then reinstall thermal material when reinstalling.

**Method 2:** Keep the logic board together with the heatsink and fans, thus avoiding the need to replace thermal material.

If not replacing the logic board or heat sink, but removing the board to facilitate another procedure, such as replacing the right speaker or bottom case, then use method 2, if desired.

**Warning:** Allowing a logic board to flex, even slightly, can damage solder joints to components. To avoid flexing, hold the board vertically along the wide sides. Do not hold the board by the ends or by the narrow neck at the fan cutout, or horizontally, as the board's weight can cause flex.

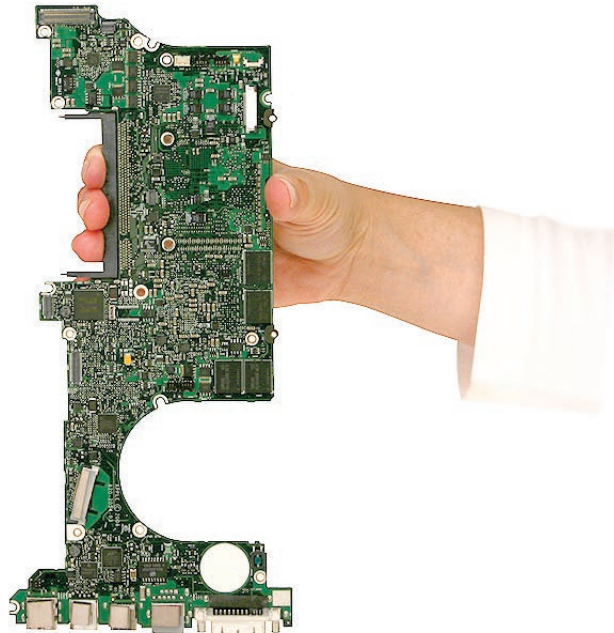

## Method 1

1. Disconnect the twelve cables shown.

**Note 1:** For the MacBook Pro (17-inch), use a needlepoint probe to disconnect the small thermal sensor and backup battery connectors from the logic board.

**Warning:** When using a needlepoint probe, great care must be used to avoid slipping off the connector and damaging components.

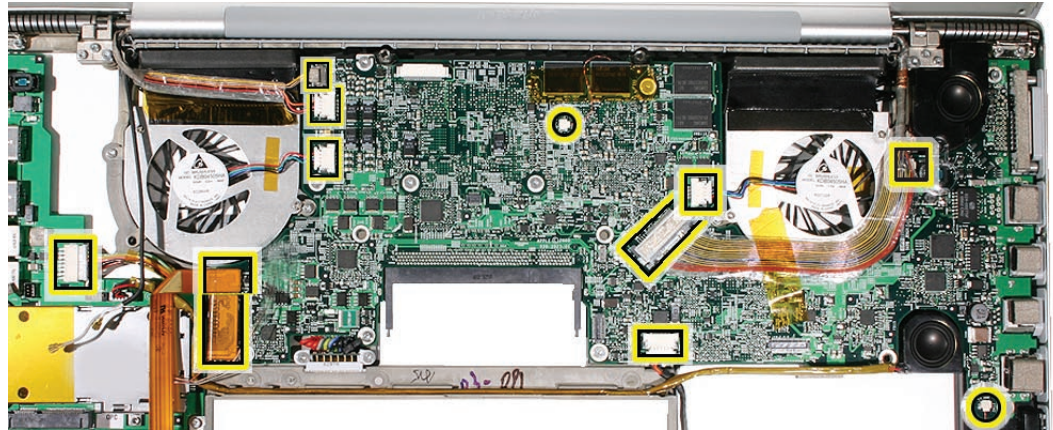

**Note 2:** For the MacBook Pro (17-inch Core 2 Duo), disconnect the [JST](#) connectors by grasping the wires as close to the connector as possible and gently lifting straight up.





2. Tape the thermal sensor cable to the display assembly to avoid getting it trapped under the logic board and forgetting it during reassembly. **Important:** Do not tape over connectors with exposed contacts. Residual adhesive from the tape can contaminate the contacts.

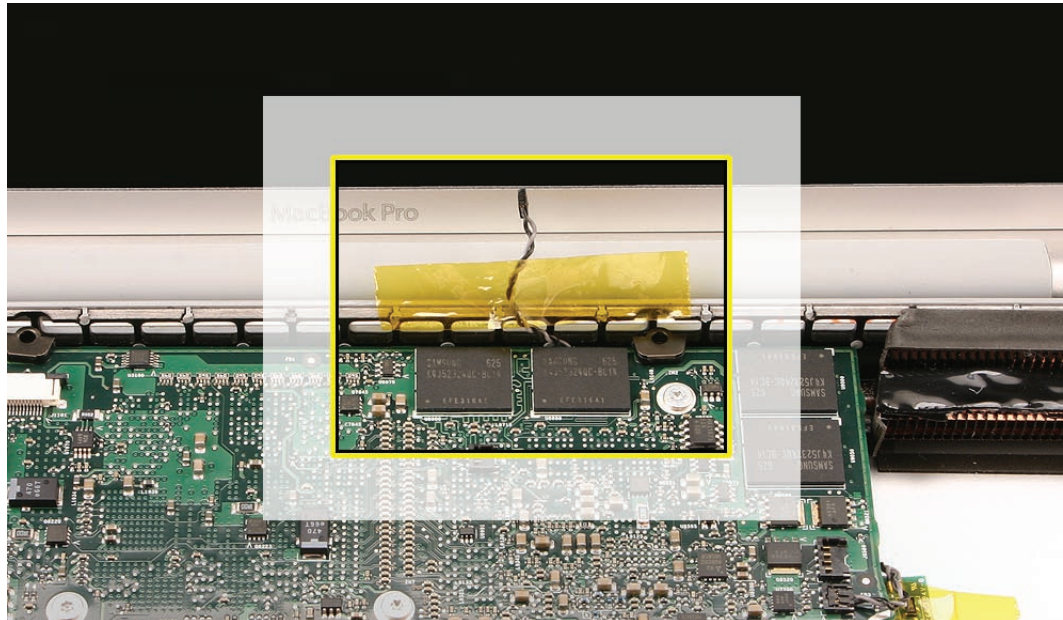

3. Remove the thirteen Torx T6 screws, shown.

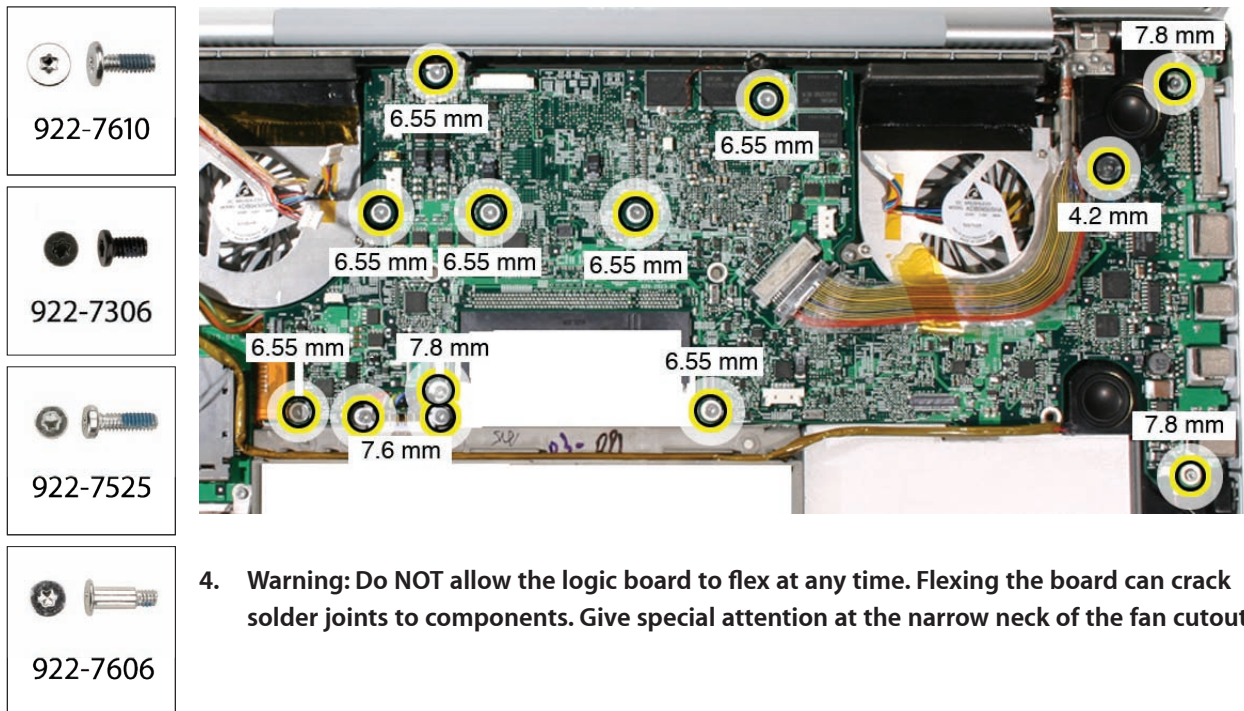

4. **Warning:** Do NOT allow the logic board to flex at any time. Flexing the board can crack solder joints to components. Give special attention at the narrow neck of the fan cutout.

- From the left side of the board, slowly begin to lift the board, avoiding any flexing, until the thermal material on the three chips underneath releases.  
**Note:** The thermal material should easily release. If not, verify that all screws and connectors have been removed



- Be sure to insert the black stick between the logic board and the plastic shield on the bottom case below. Avoid lifting from under the plastic shield.

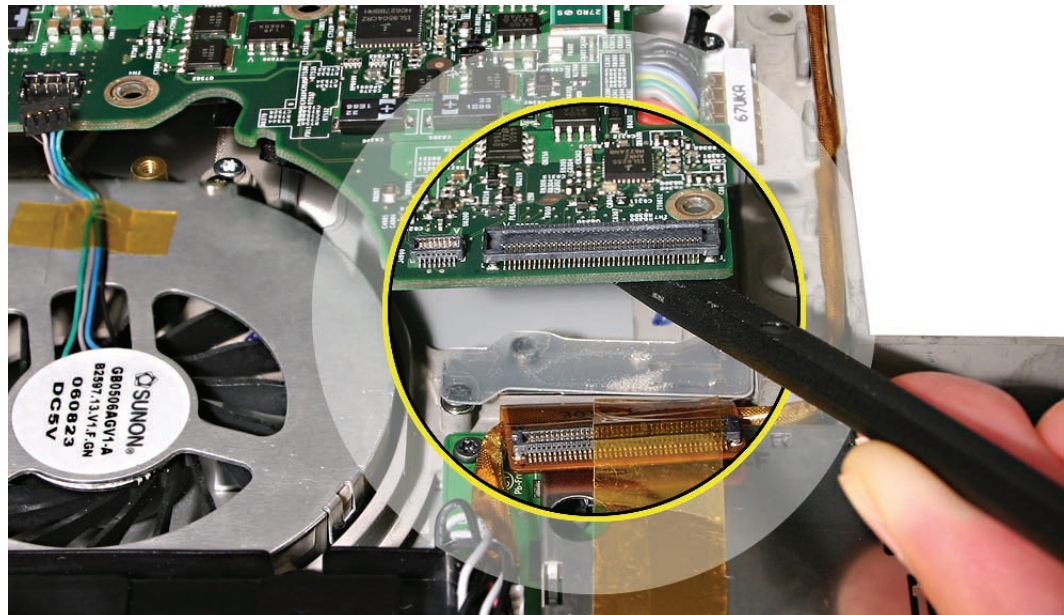

7. Carefully lift the left side of the board, supporting the board along its sides as it lifts, and pivot along the ports side as you finesse it clear of the port openings..

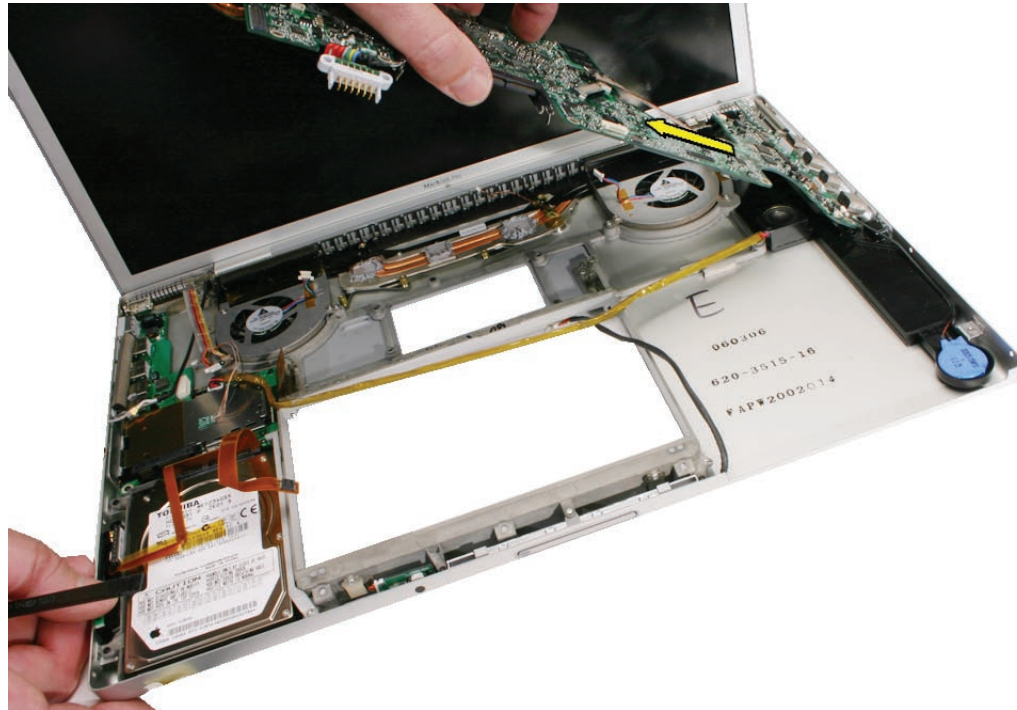

8. Remove the logic board.

**Important:** In the MacBook Pro (17-inch Core 2 Duo) only, there are two metal shims on the *under* side of the logic board near the graphics chip (see callouts below). If reusing this logic board, make sure those shims retain their position above the heat sink posts.

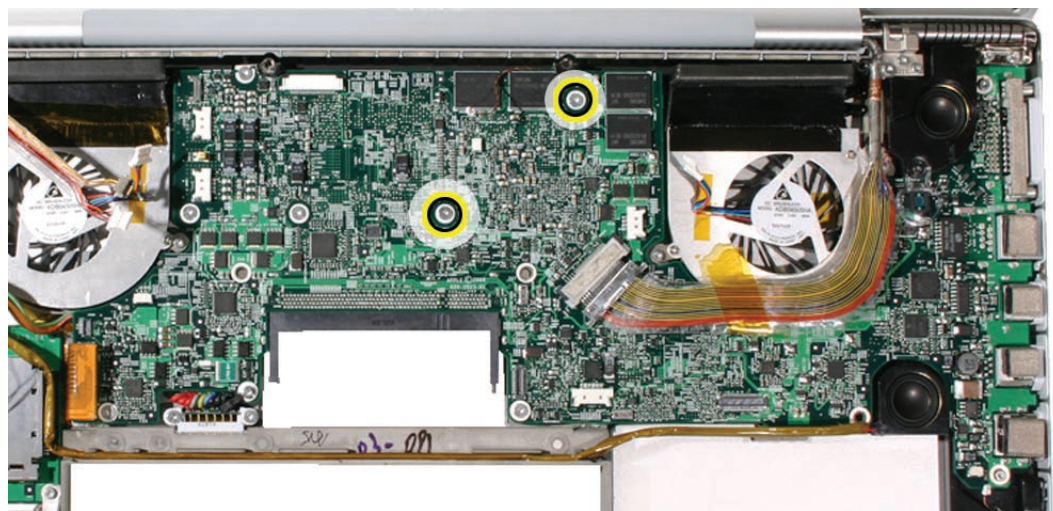

## Method 2

1. Disconnect the ten cables shown. (Note: some of the cable connectors in the MacBook Pro (17-inch Core 2 Duo) may be [JST](#) connectors, not pictured below.)

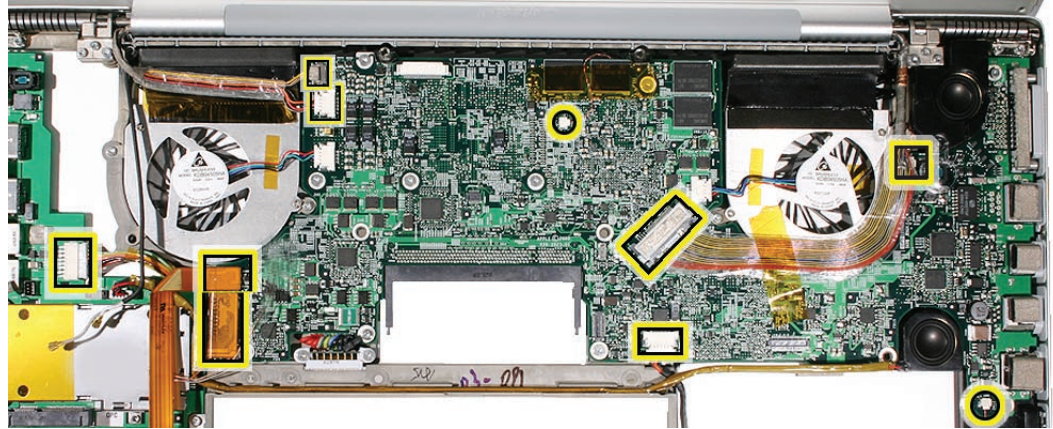

2. Tape the thermal sensor cable to the display assembly to avoid getting it trapped under the logic board and forgetting it during reassembly. **Important:** Do not tape over connectors with exposed contacts. Residual adhesive from the tape can contaminate the contacts.

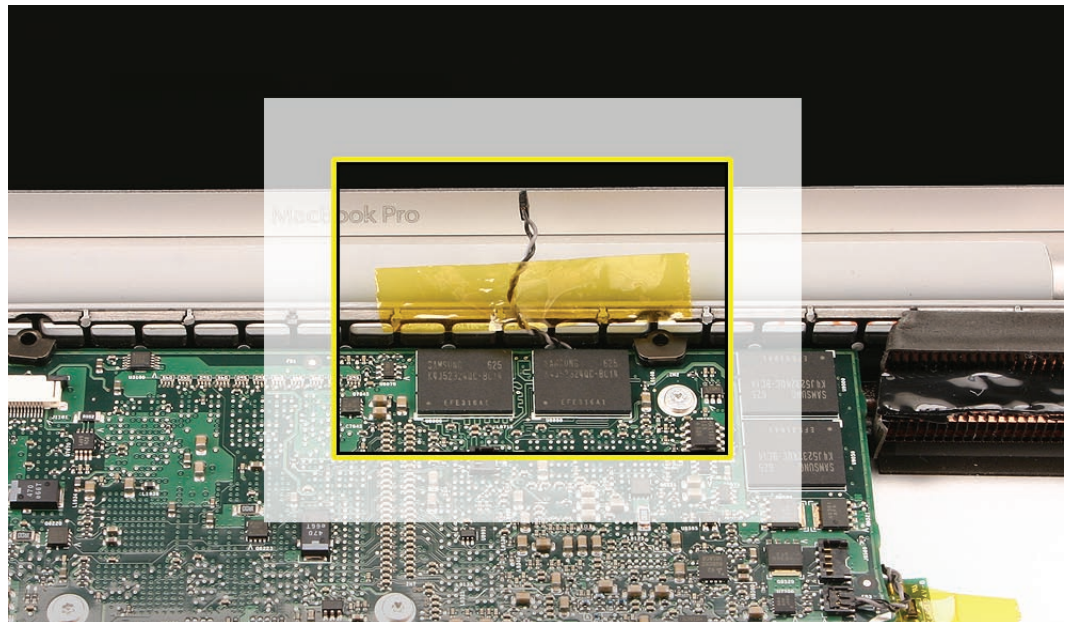

3. Remove the twelve Torx T6 screws, shown. Two screws that secure the fan to the frame are indicated below under the LVDS cable.

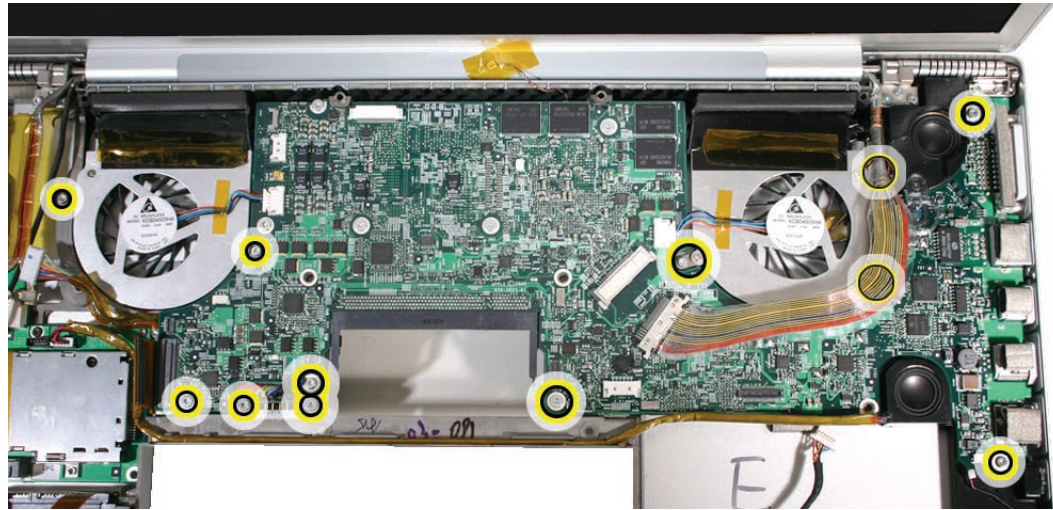

4. **Warning: Do NOT allow the logic board to flex at any time. Flexing the board can crack solder joints to components. Give special attention at the narrow neck of the fan cutout.**
5. Use a black stick under the extension of the heatsink, just below the rear of the left fan, then slowly begin to lift the board, avoiding any flexing.  
**Note:** The the logic board and heatsink assembly, along with the fans, should easily lift up. If not, verify that all the appropriate screws and connectors have been removed.

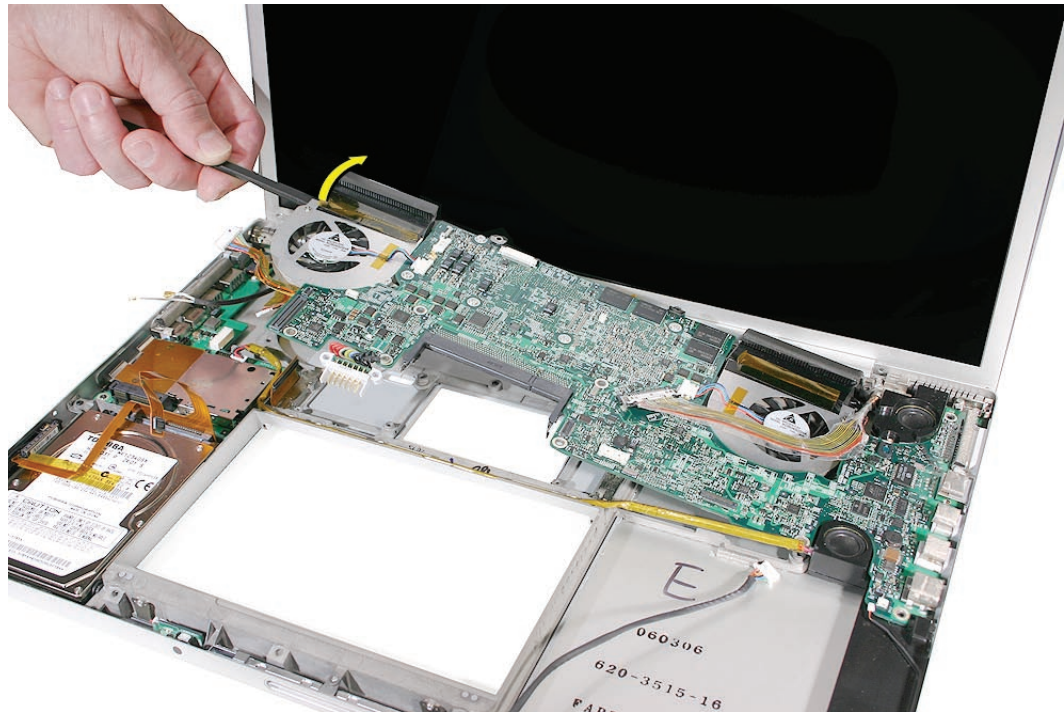

- 
6. Support the assembly as it lifts, and pivot along the ports side as you finesse it clear of the port openings.



7. Remove the assembly.

## Replacement Procedure

1. Verify that the EMI gaskets are in place along the port openings on the bottom case.

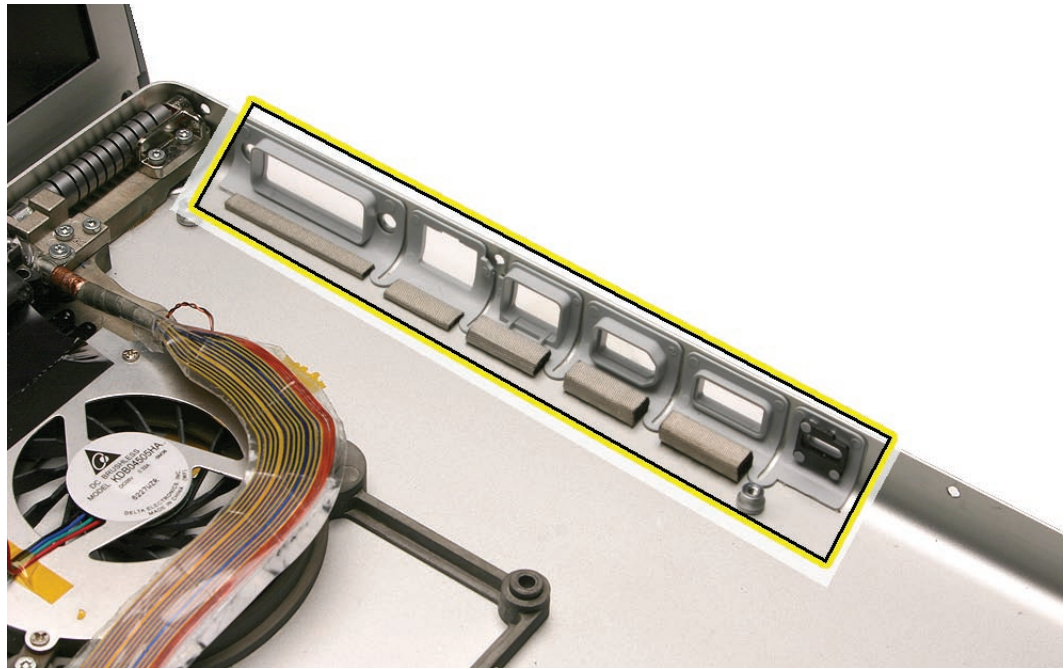

2. If replacing the logic board, transfer the two screw guides, called sleeves, along top edge of the board.

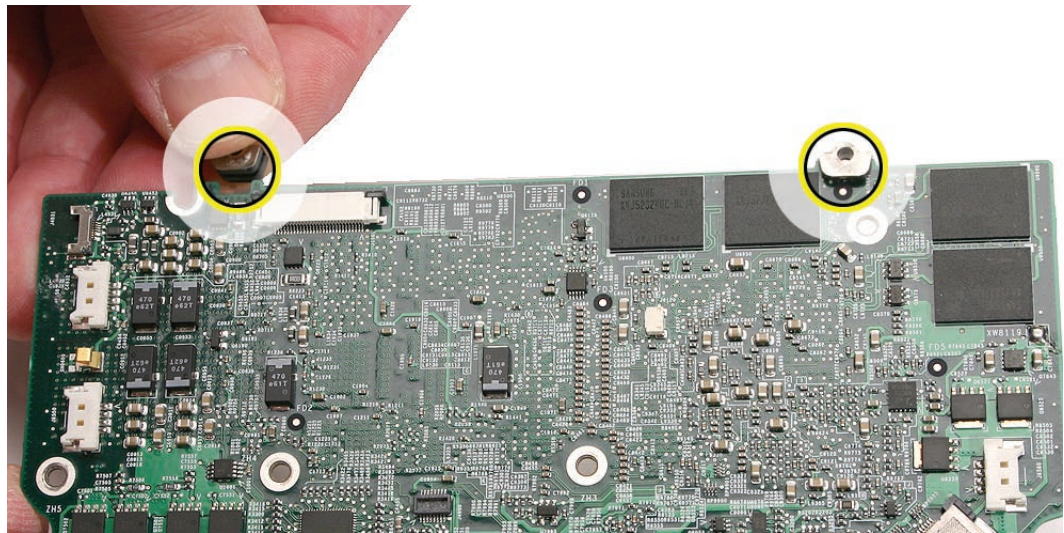

**Important:** There are two metal shims on the *under* side of the logic board near the graphics chip. (See screws #4 and #5 in the screw replacement order in step 14, following.) Make sure those shims retain their position above the heat sink posts when replacing.

3. **Warning:** If the logic board was removed to facilitate another procedure and will be reinstalled, the existing thermal grease cannot be left on the board and must be completely cleaned off, since it will create a thermal barrier if combined with new grease. Use the following procedures to clean off the old thermal grease—or overheating and damage can result.
4. Use a black stick to remove the grease from the mating surfaces of the three chips.  
**Important:** Use extreme care not to damage the chips or logic board components.
5. Use alcohol wipes to completely clean the grease from the surfaces and surrounding area.

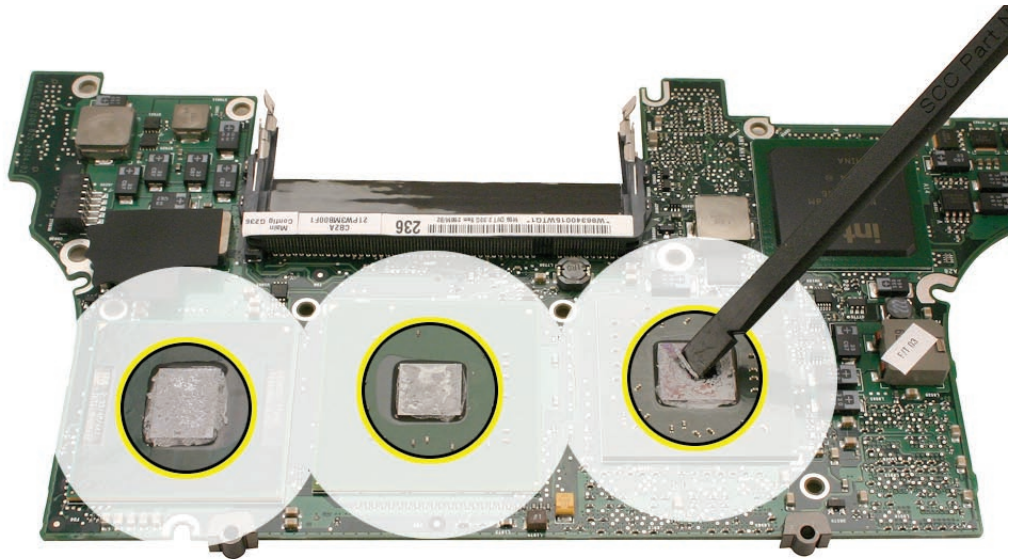

- Install EMI gaskets and tape on the ports from the gasket kit.

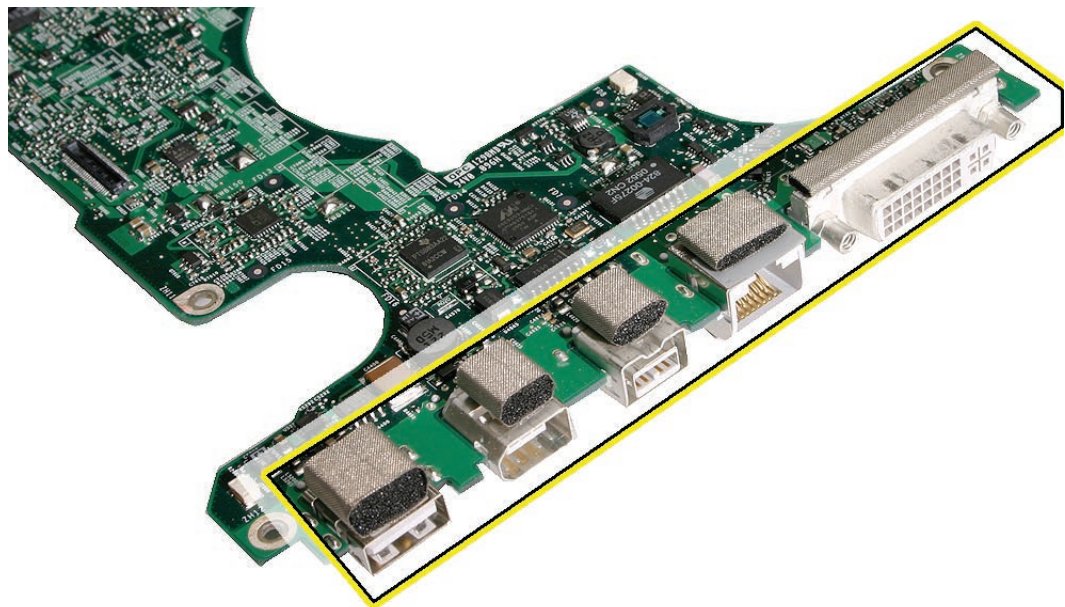



- Transfer the cosmetic shield, if needed.
- Transfer the battery cable and the left I/O board cable

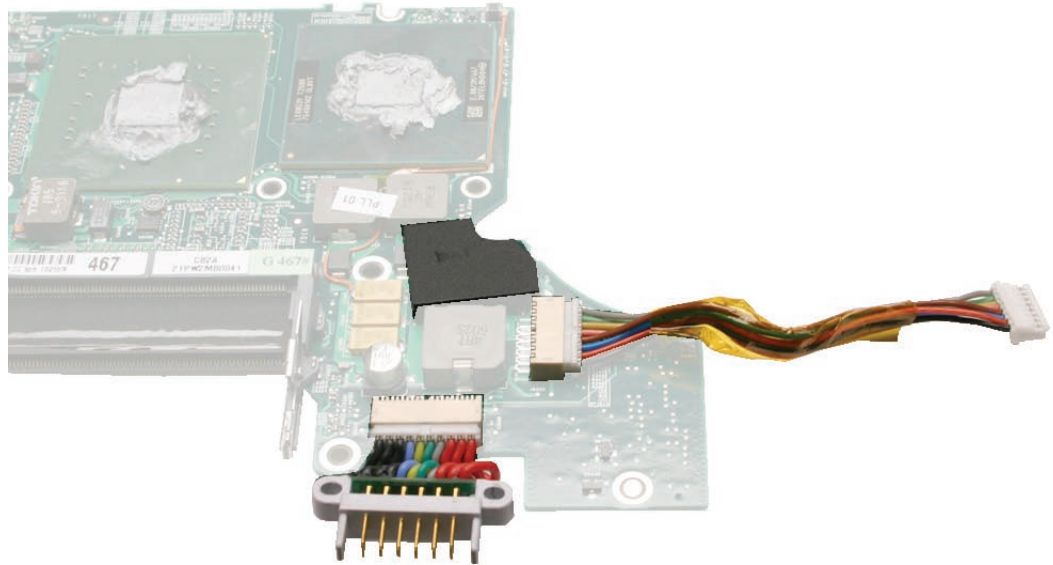

**Warning:** Used/existing thermal grease cannot be reused and must be completely cleaned off, since it will create a thermal barrier if combined with new grease.

Use the following procedures to clean off the old thermal grease, and then to reinstall new thermal grease—or overheating and damage can result.

6. Use a black stick to remove the thermal grease from the three mating surfaces.
7. Use alcohol wipes to completely clean the grease from the surfaces and surrounding area.

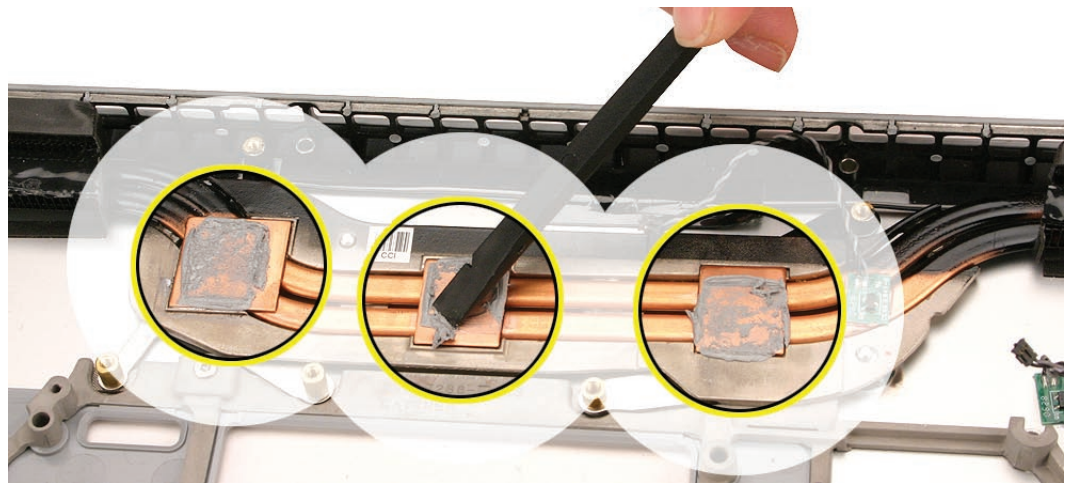

**Warning:** Whenever the logic board is separated from the heatsink, the thermal grease must be replaced. Failure to do so can cause the computer to overheat and be damaged.

**Important:** Avoid unnecessary contact with new thermal material, as dirt and body oils reduce the material's conductivity.

- Note the contents of the syringe of thermal grease. **Important:** One syringe (922-7144) contains 0.3 to 0.35 cubic centimeters (cc) of thermal grease. That is enough for 0.1 to 0.12 cc of grease per chip for up to three chips. Use one-third of the syringe contents per chip. Using a felt-tip pen, mark the 1/3 points on the syringe before applying the first dab. .



- Put a 0.1 - 0.12cc dab of thermal grease, in the center, on each chip mating surface, as shown.

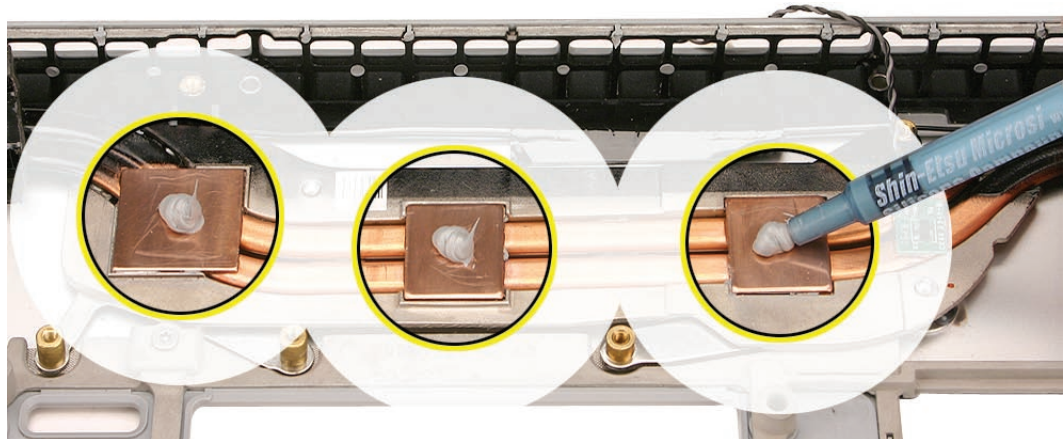

- When replacing the logic board:
  - Verify that the right speaker chamber is installed.
  - Verify that the two screw guide "sleeves" are installed on the top of the board.
  - Guide the logic board's port side into the port openings on the bottom case.
  - Verify that no cables are caught under the board when lowering into place.
  - Important:** Check for two metal shims on the under side of the logic board near the graphics chip. Make sure those shims retain their position when replacing.

11. To insure that the logic board sits flat, tuck the lower right edge of the logic board under the ridge just above the lower speaker driver on the right speaker (as shown below).

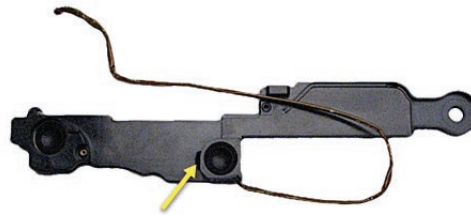

12. Tuck the battery cable under the frame as the board goes into place.

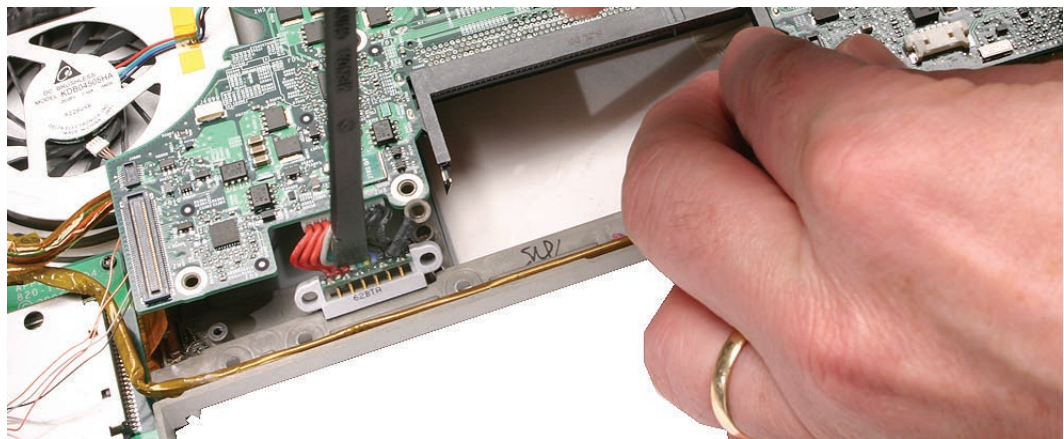

13. Verify, at the check points below, that no cables are caught under the board and that the screw sleeves are installed.

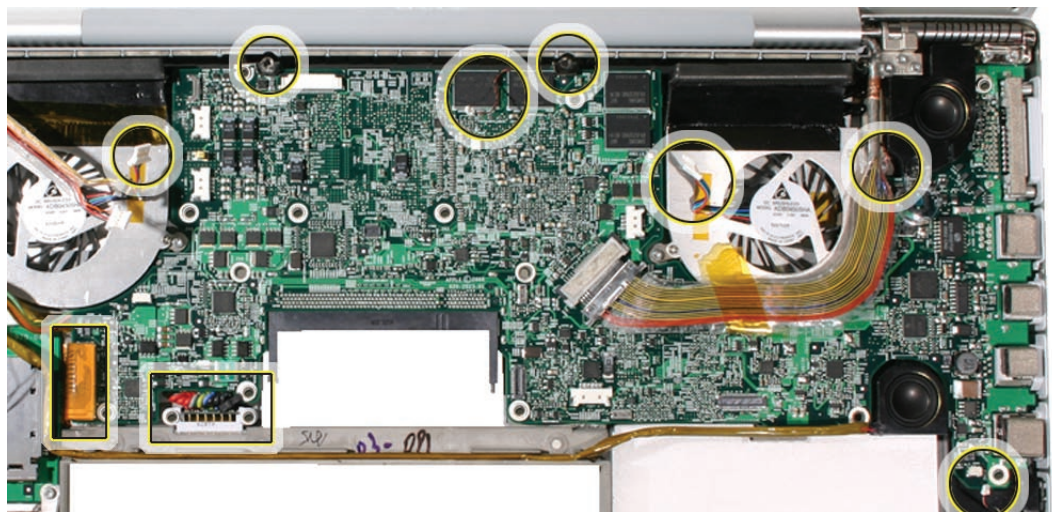

14. Attach the logic board screws in the order show below, including the screw for the right ALS dust cover and the two shoulder screws for the battery cable assembly.

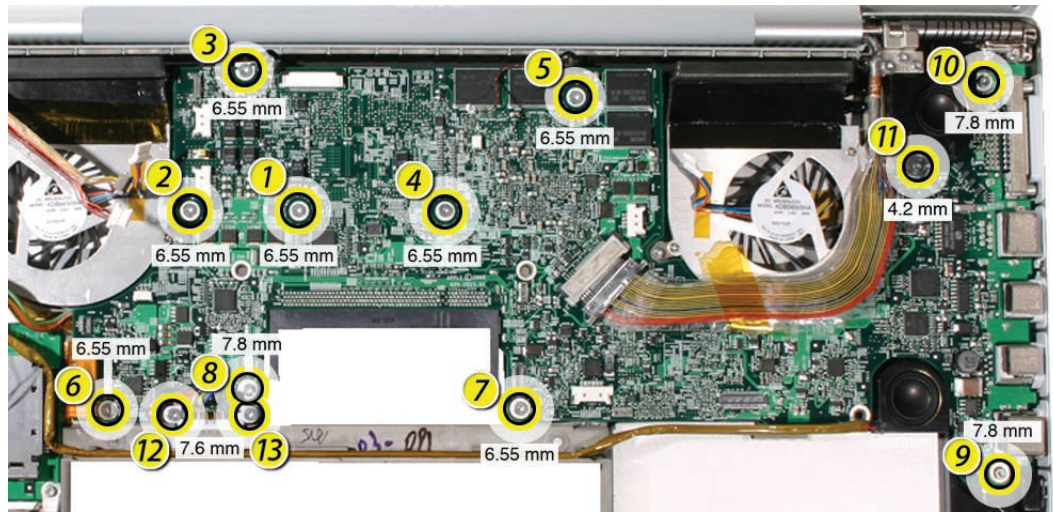

15. Verify that the battery cable ground strap is secured by the screw, as shown.

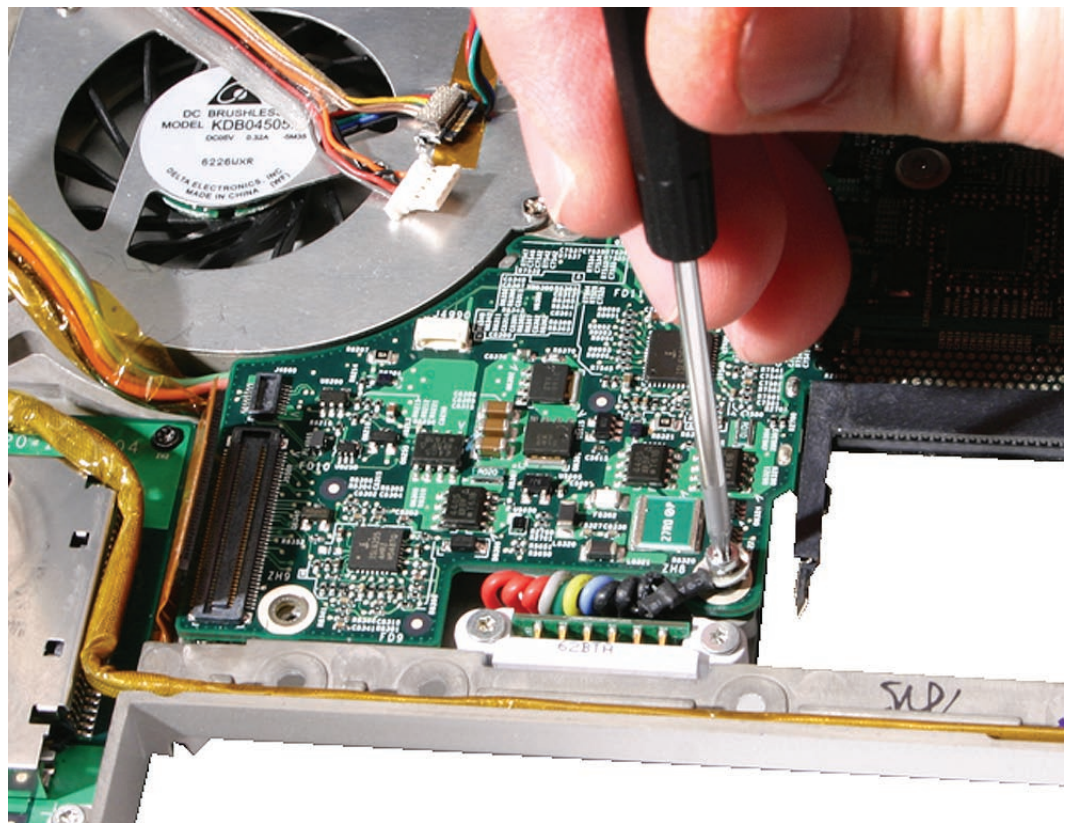

16. Verify that the EMI gasket is on the camera cable connector.

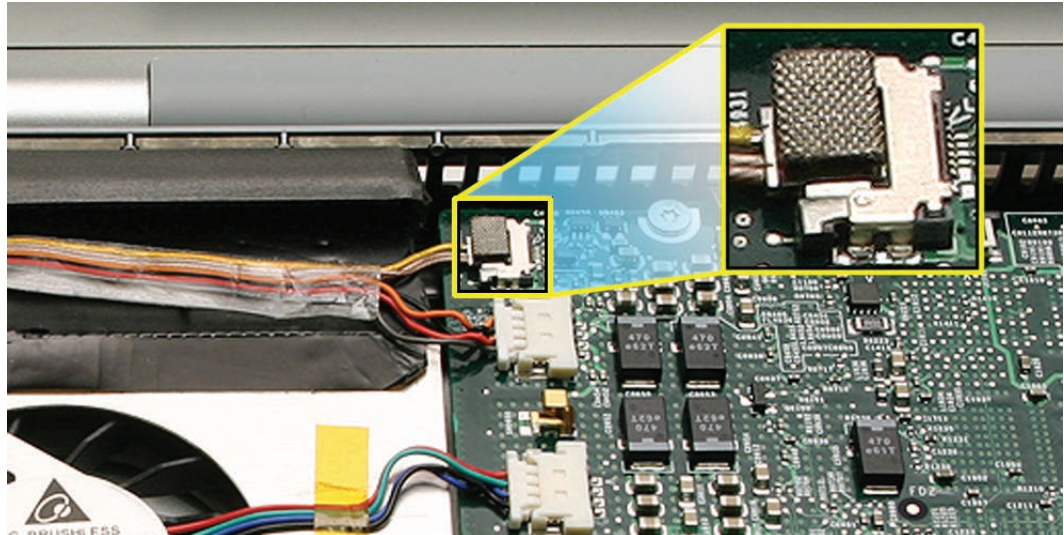

17. Verify that the ExpressCard cage flex connector, from the left I/O board, is seated properly. If the connector on the flex is not lined up with the connector on the logic board, a bad connection with a characteristic bow, shown below, can occur.

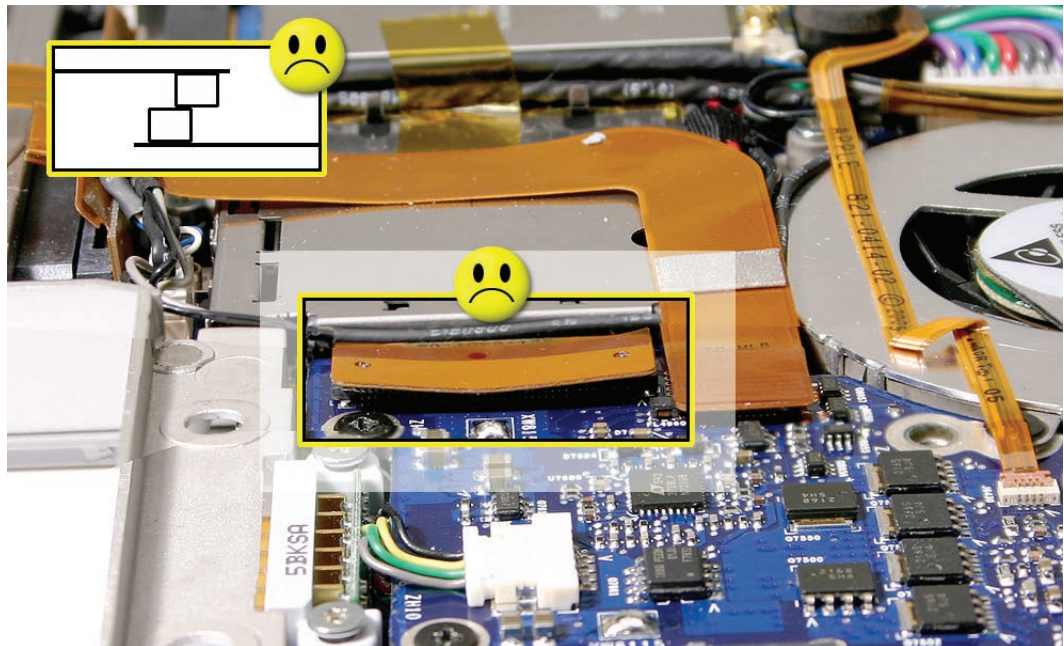

18. Reassemble and test all ports, components and functions of the computer.

**Note:** After installing new thermal grease, if you must briefly re-separate the logic board from the heatsink, it is acceptable to retain the same, new thermal grease, as long as it is not



# Battery Cable Assembly

## Tools

This procedure requires the following tools:

- Black stick (nylon probe 922-5065) or other non-conductive nylon or plastic flat-blade tool

## Preliminary Steps

Before you begin, remove the following:

- [Battery](#)
- [Top Case](#)
- [Logic Board](#)

## Part Location

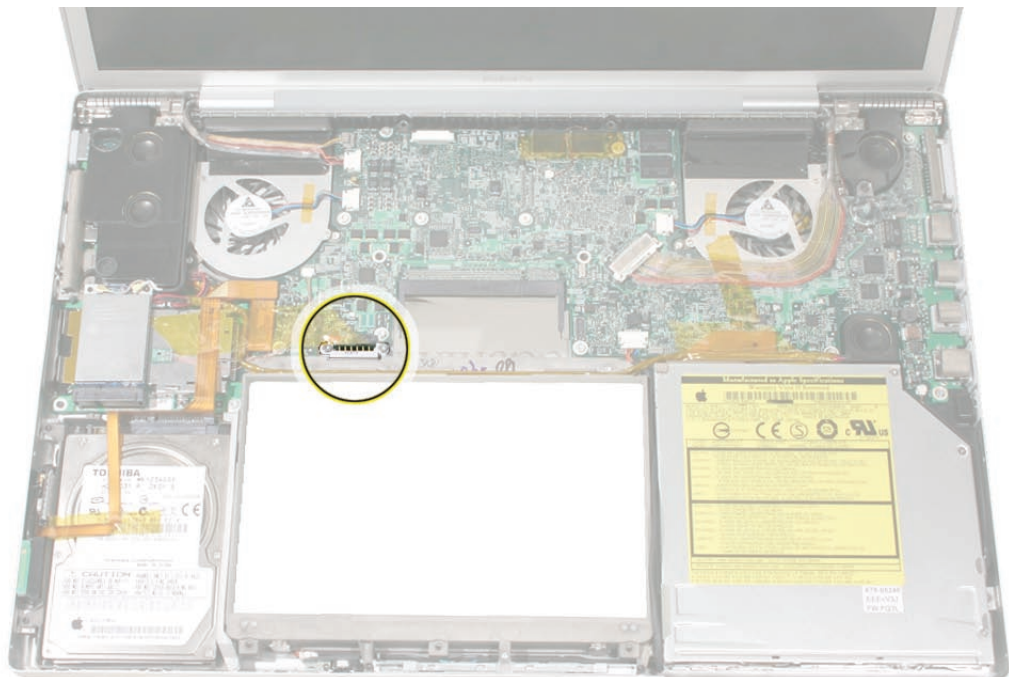

## Procedure

1. Disconnect the cable from the bottom of the logic board.

**Note:** Two shoulder screws mount the battery cable to the bottom case but are removed during the logic board takeapart procedure..

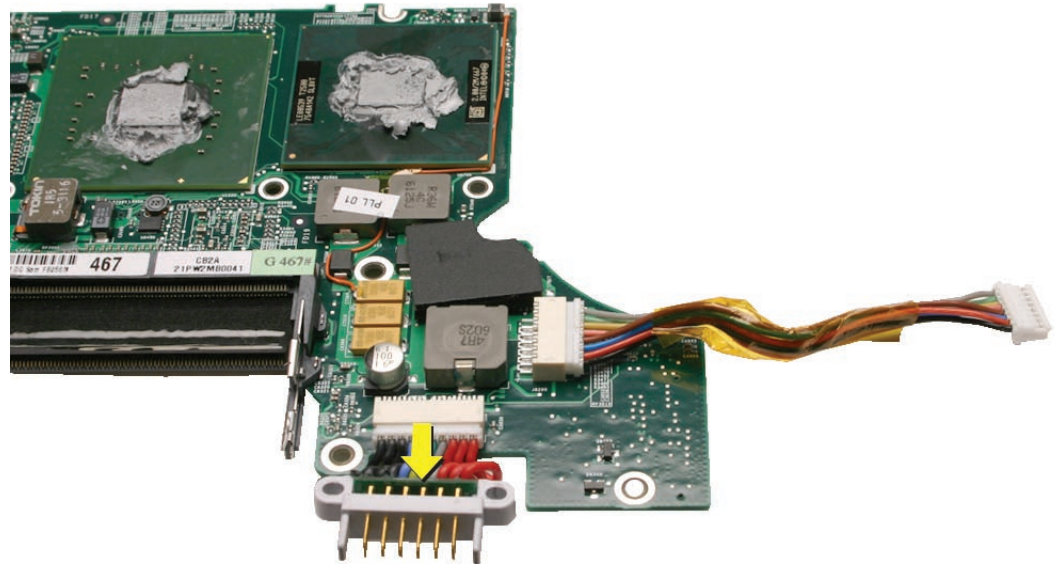



# Thermal Sensors

**Important:** There are two thermal sensors, each requiring precise placement. One sensor is attached to the bottom case and one to the heatsink—they are NOT interchangeable.

## Tools

This procedure requires the following tools:

- Fine-point felt-tip permanent marker
- Razor knife
- Needle-point metal probe
- Kapton tape (922-1731) (0.5-inch x 12-yard roll)
- Black stick (nylon probe 922-5065) or other non-conductive nylon or plastic flat-blade tool

## Preliminary Steps

Before you begin, remove the following:

- [Battery](#)
- [Top Case](#)
- [Right Fan](#) (for bottom case sensor)
- [Logic Board](#) (for heatsink sensor)

## Heatsink Sensor Location

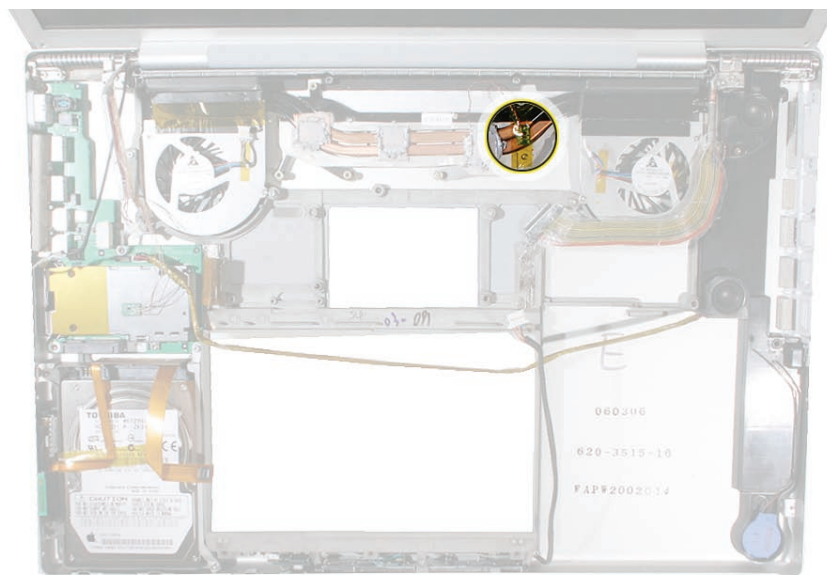



**Bottom Case Sensor Location: MacBook Pro (17-inch)**

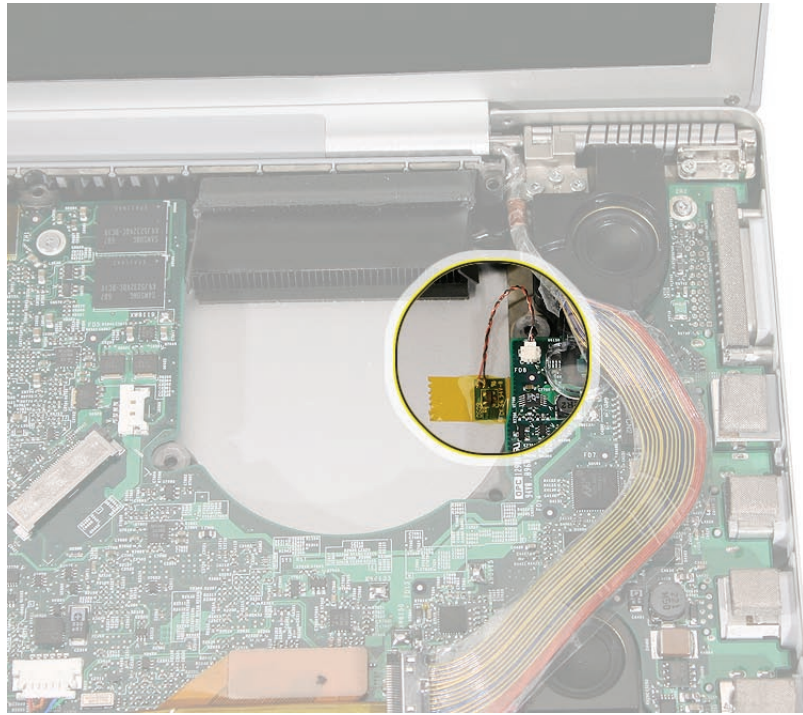

**Bottom Case Sensor Location: MacBook Pro (17-inch Core 2 Duo)**

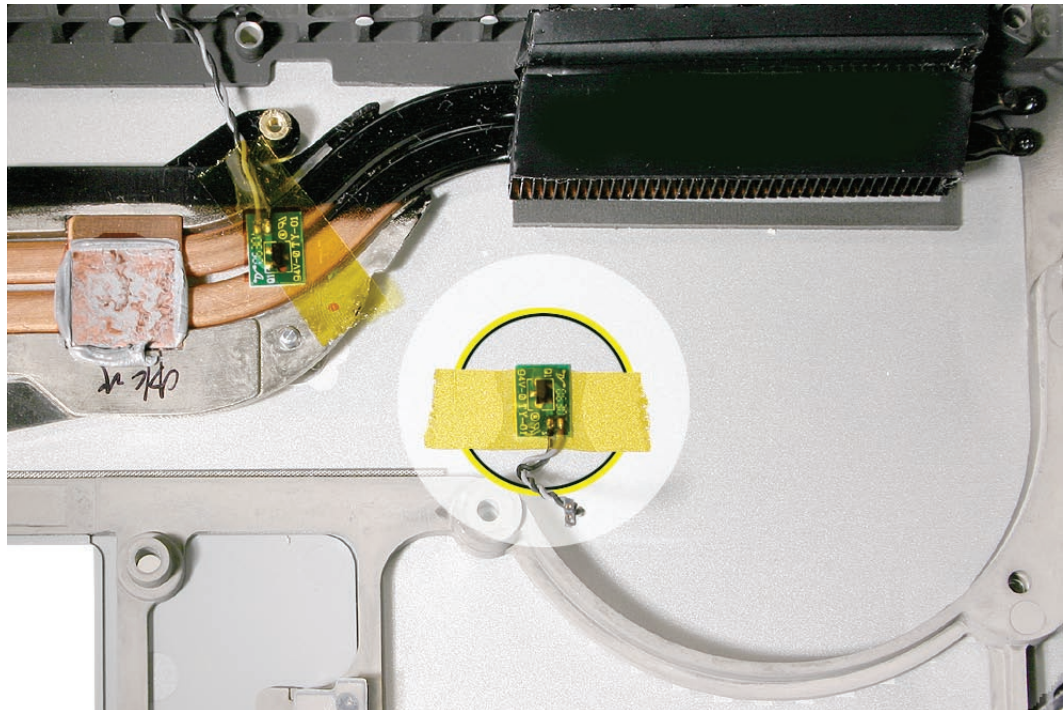

## Procedure

1. For either sensor, peel back any Kapton tape, then before removing the board, mark the outline of its position with a permanent fine-point felt-tip marker.

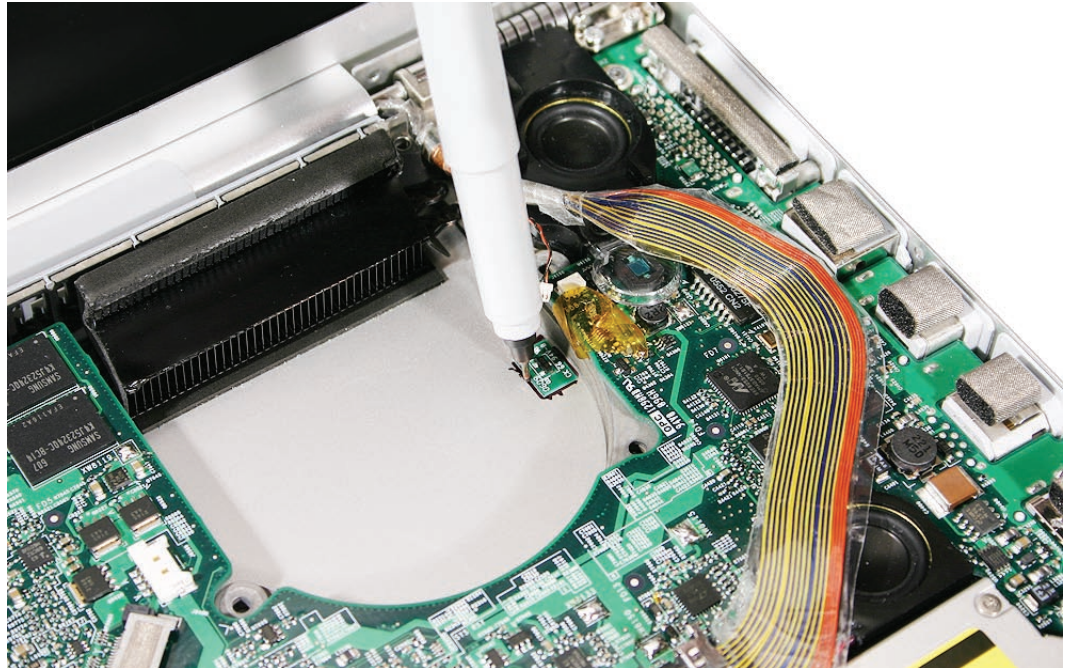

2. Pry up the sensor board with a razor knife.

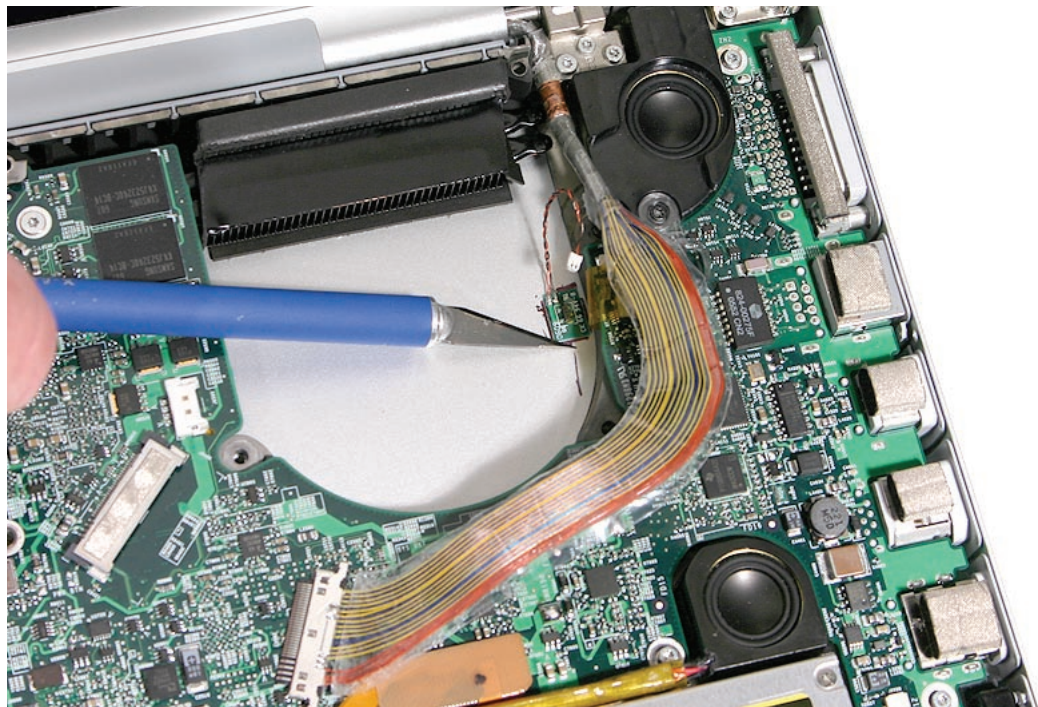

- 
3. **Note:** The connector for the heatsink sensor is disconnected when removing the logic board.
  4. When removing the bottom case sensor on the MacBook Pro (17-inch), use a needlepoint probe to disconnect the cable connector from the logic board.

**Warning:** When using a needlepoint probe, great care must be used to avoid slipping off the connector and damaging components.

**Note:** The MacBook Pro (17-inch Core 2 Duo) will have [JST](#) connectors on both the bottom case thermal sensor and heatsink thermal sensor.

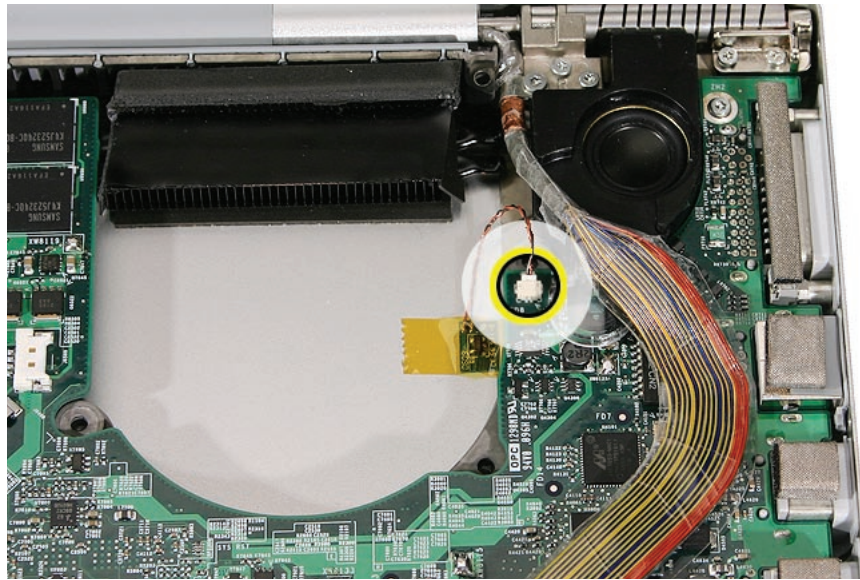

5. Install the replacement sensors in the exact same location.
6. Replace any Kapton tape.



# Heatsink

## Tools

This procedure requires the following tools:

- Black stick (nylon probe 922-5065) or other non-conductive nylon or plastic flat-blade tool

## Preliminary Steps

Before you begin, remove the following:

- [Battery](#)
- [Top Case](#)
- [Logic Board](#)

## Part Location

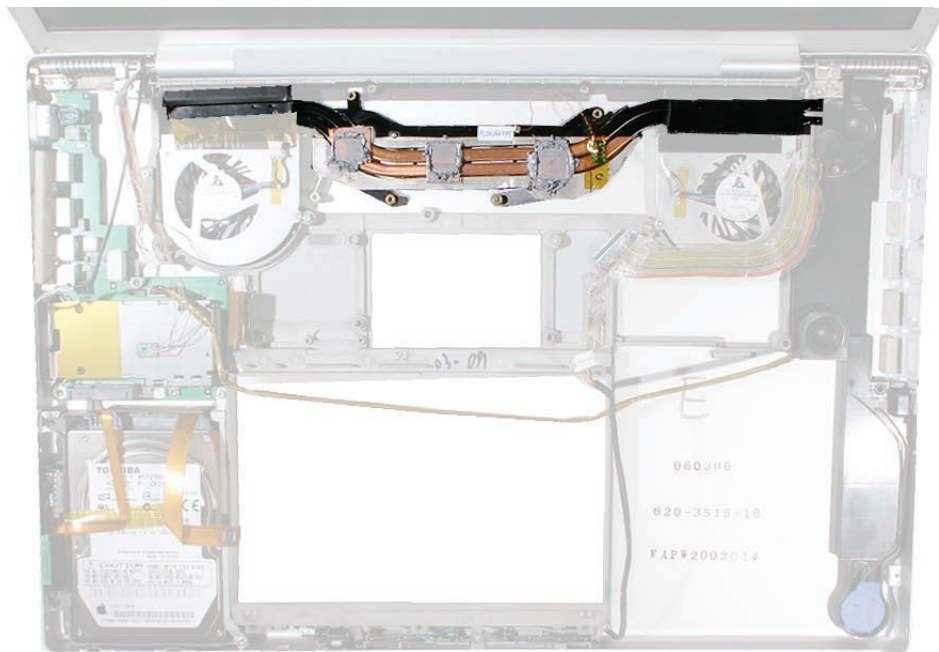

---

## Procedure

1. If the fans will not be removed, cut the tape between the fans and the heatsink (as described in the [Fans](#) Chapter), then lift out the heatsink.

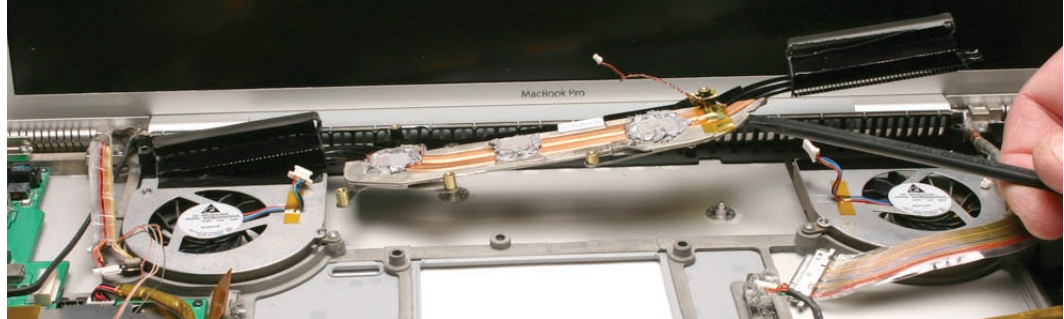

2. When installing the heatsink, make sure that it fits over the pins, shown, and lays flat.

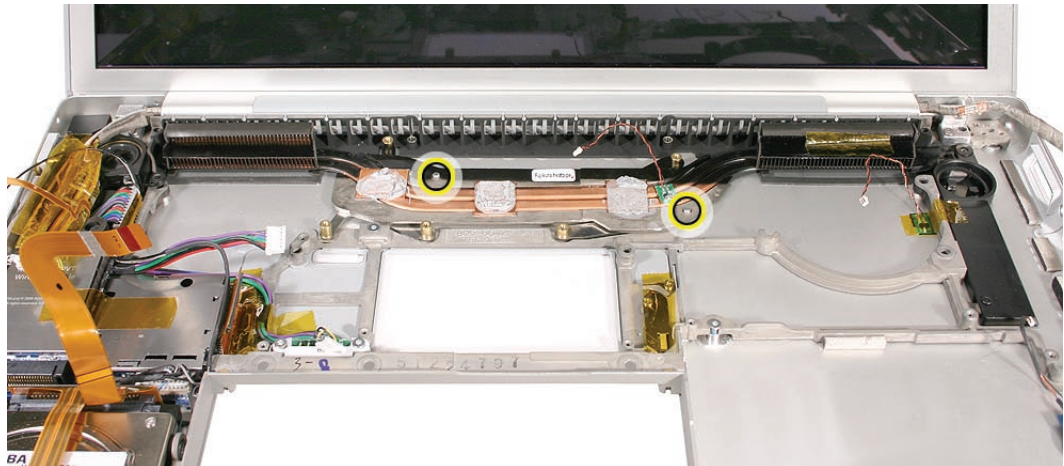

3. Make sure to install new thermal grease as outlined in the [Logic Board](#) chapter.



# Bottom Case

## Tools

This procedure requires no tools.

## Preliminary Steps

Before you begin, remove the following:

- [Battery](#)
- [Top Case](#)
- [AirPort Extreme Card](#)
- [Hard Drive](#)
- [Bluetooth](#)
- [Infrared Board](#)
- [Optical Drive](#)
- [Speakers](#)
- [Left I/O Board](#)
- [Fans](#)
- [Logic Board](#)
- [Heatsink](#)
- [Display Assembly](#)

---

## Part Location

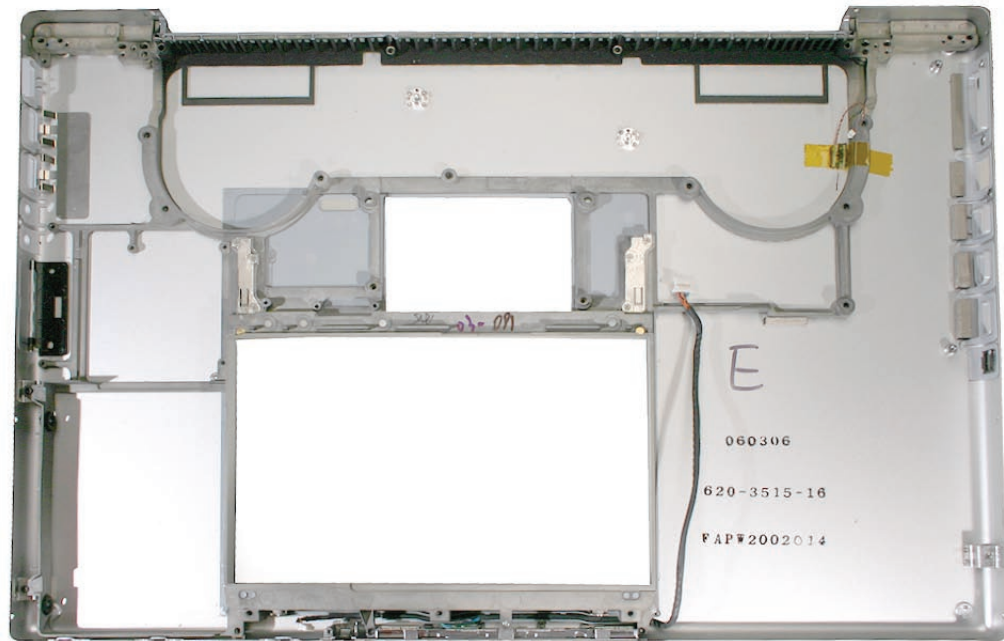

## Procedure

**Note:** If replacing the bottom case, use a razor knife to carefully lift and transfer the Serial Number and Ethernet ID labels to the replacement bottom case.

After the parts are removed in the preliminary steps, what's left is the bottom case..



# Display Assembly

## Tools

This procedure requires the following tools:

- Torx T6 screwdriver (magnetized)
- Black stick (nylon probe 922-5065) or other non-conductive nylon or plastic flat-blade tool

## Preliminary Steps

Before you begin, remove the following:

- [Battery](#)
- [Top Case](#)

## Part Location





## Procedure

1. Disconnect two antenna connectors for the MacBook Pro (17-inch) or three connectors for the MacBook Pro (17-inch Core 2 Duo) from the AirPort Extreme card. Lift straight up.  
**Note:** Take note of the order of the antenna connectors for reinstallation purposes.
2. Disconnect three cable connectors on the logic board—the camera and inverter connectors and the LVDS connector.



3. Remove the four clutch spring end cap screws, two each side.

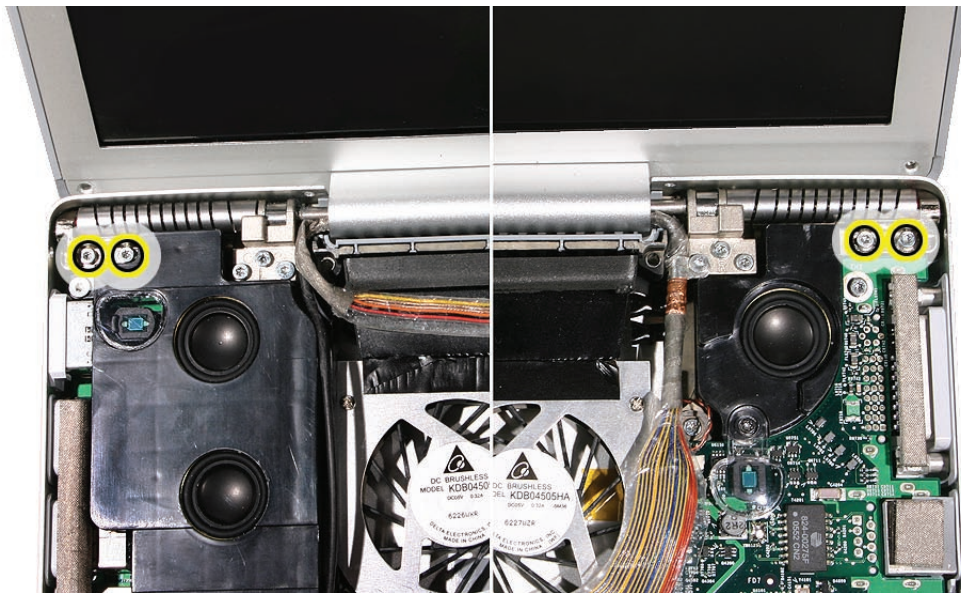

4. Move the display straight up to a 90-degree angle and remove six clutch block screws, three on each side.

**Important:** Support the display from falling over before removing the last screw.

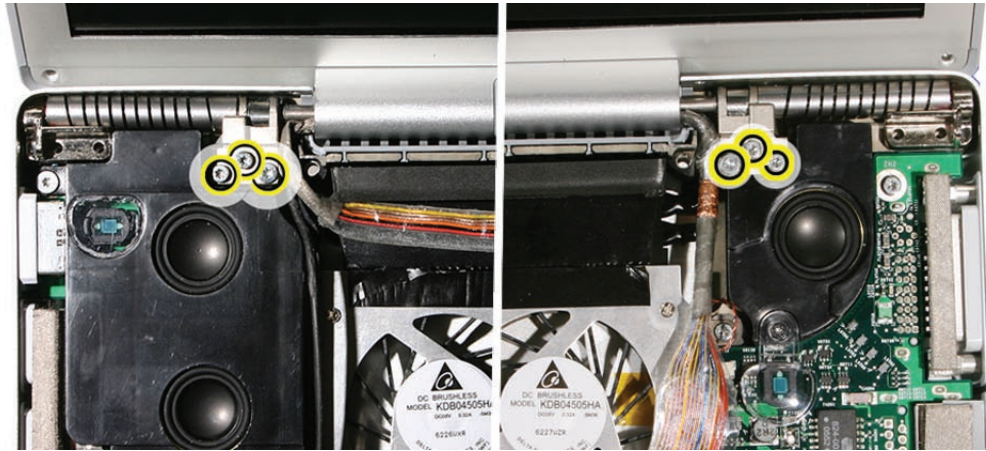

5. Lift the display straight up and off of the computer without catching wires.



- 
6. Remove the clutch spring end caps from each side.



## Replacement Procedure

1. Before installing the display assembly, verify that all cables are routed out of the way.
2. Install the replacement display assembly, and reconnect all cables and antennas.
3. Make sure to capture the LVDS cable grounding loop with the screw, and that the cable is secure and lays flat.



4. Verify that the EMI gasket is on the camera cable connector.

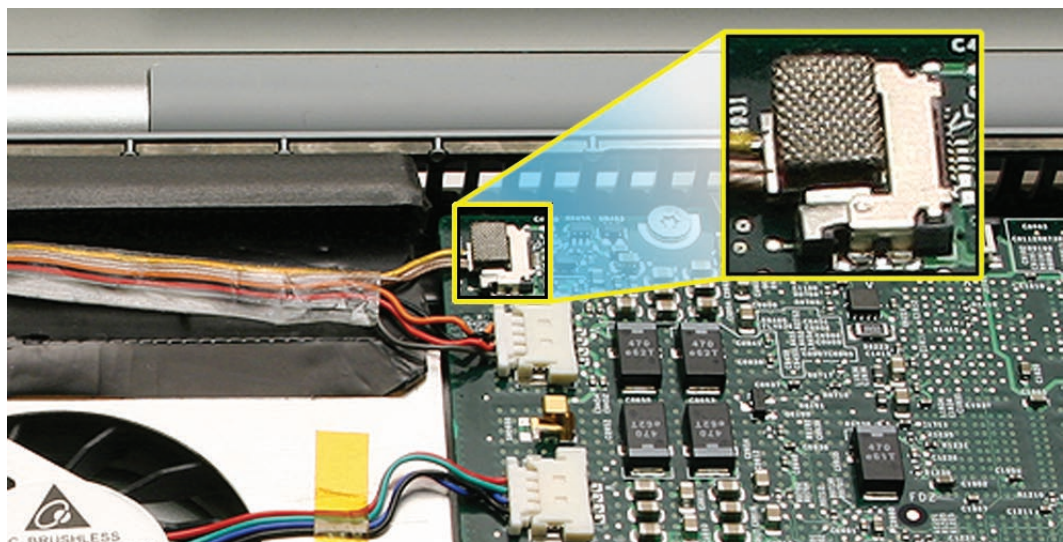

5. Verify that the antenna cables lay flat within the channel along the edge of the speaker.

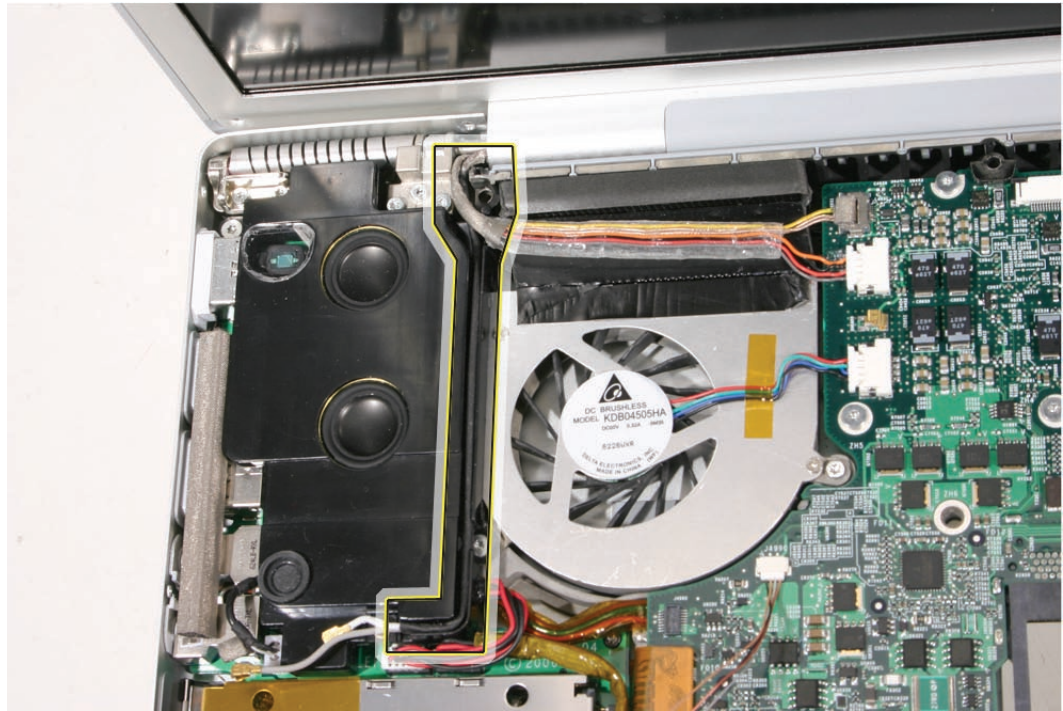

6. If not, use Kapton tape to secure, as shown.

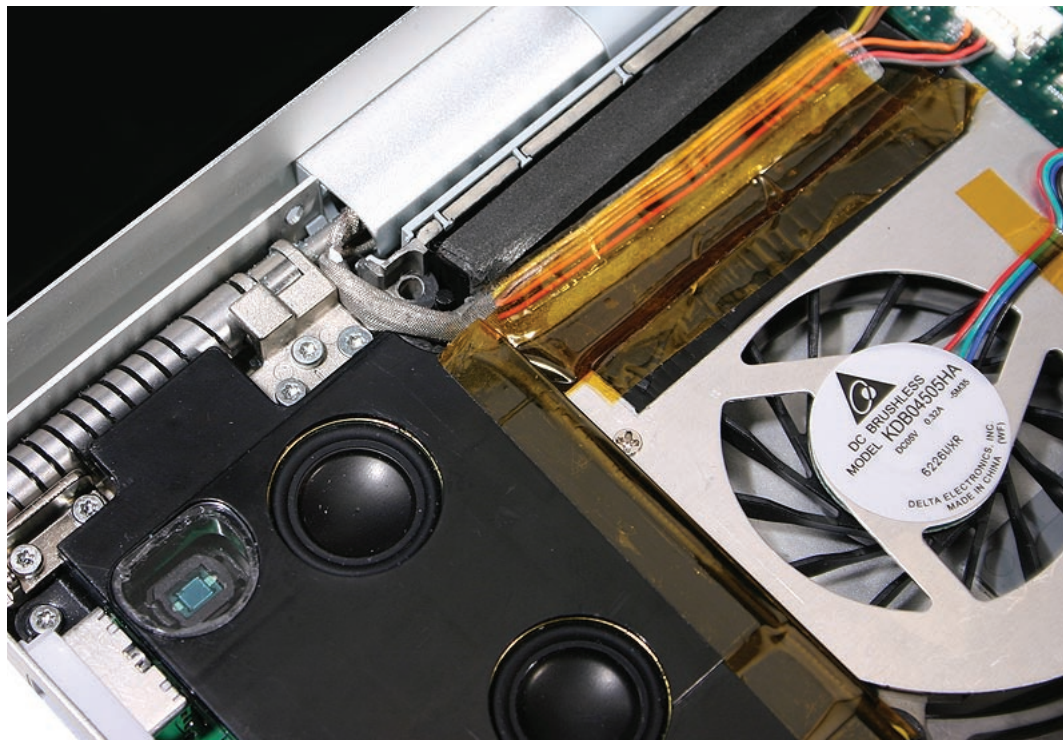

7. And verify that the cables for the antennas, and camera and inverter, route to the left of the pin and screw hole at the top right corner of the speaker.

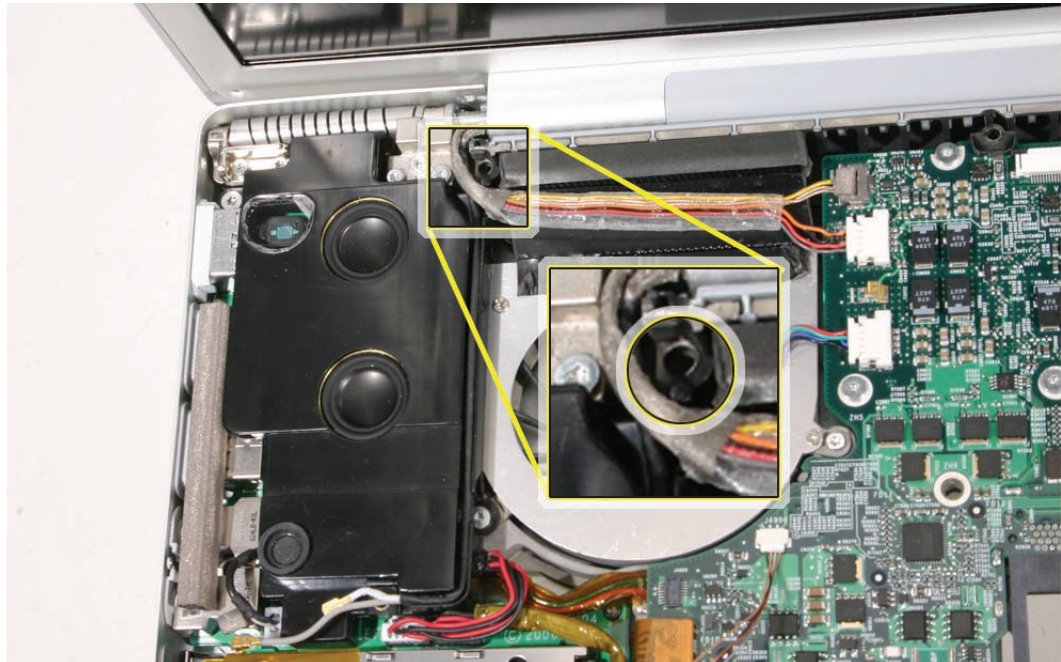

8. Reassemble and test the computer.
9. Testing the computer should include:
  - Testing that the display panel functions properly.
  - Use Apple System Profiler to check that the AirPort Extreme card is recognized, and test that AirPort Extreme is working.
  - Check the camera function.
  - Check that the trackpad and keyboard function properly.
  - Operate the computer in a darkened room to check for keyboard backlight function.

---

Apple Service Source



Troubleshooting

---

MacBook Pro  
(17-inch & 17-inch Core 2 Duo)



## General Information

### Wire and Flex Cables

Because of its extremely thin enclosure design and dispersed circuit board, the MacBook Pro utilizes a large number of flex cables and variety of wire cable harnesses. Many of these cables carry multiple types of signals.

Here is a list of the cables and the signals that run across them. If you notice a group of functions not working, it is likely that the cable is not properly inserted or the connector is damaged.

Cable or Flex Cable	Signal(s) Running Through It
SuperDrive flex	SuperDrive data, power, and control signals (cable select info)
Hard drive flex	Hard drive power and data Bluetooth power and data
Left I/O board flex	Audio in and out left USB (2 ports) ExpressCard data, left ALS, AirPort
Power Button cable	Power-on signal
Infrared Cable	Infrared Power and data
Sleep LED cable	Power to sleep LED
Main battery connector wire harness	Battery power to main logic board
Speaker Assembly cable (left)	Left speakers (2) audio
Speaker Assembly cable (right)	Right speakers (2) audio
Internal microphone	Internal microphone audio
Trackpad flex	Trackpad data and power Power on button Keyboard backlight power Sleep sense signal Keyboard data
Bluetooth antenna cable assembly	Bluetooth radio signal
AirPort Extreme antenna cable	AirPort Radio signal
Left fan cable	Power/control for left fan
Right fan cable	Power/control for right fan
Inverter cable (to logic board)	Display backlight control Inverter control signal (brightness)
iSight video signal cable	Video power and signal from iSight camera
LVDS cable	Video data
Thermal sensors (bottom case, heatsink)	Internal temperature data



---

## Microphone and Camera wires

The following photo shows the microphone wires located on the left speaker, and the camera connector located on the logic board.

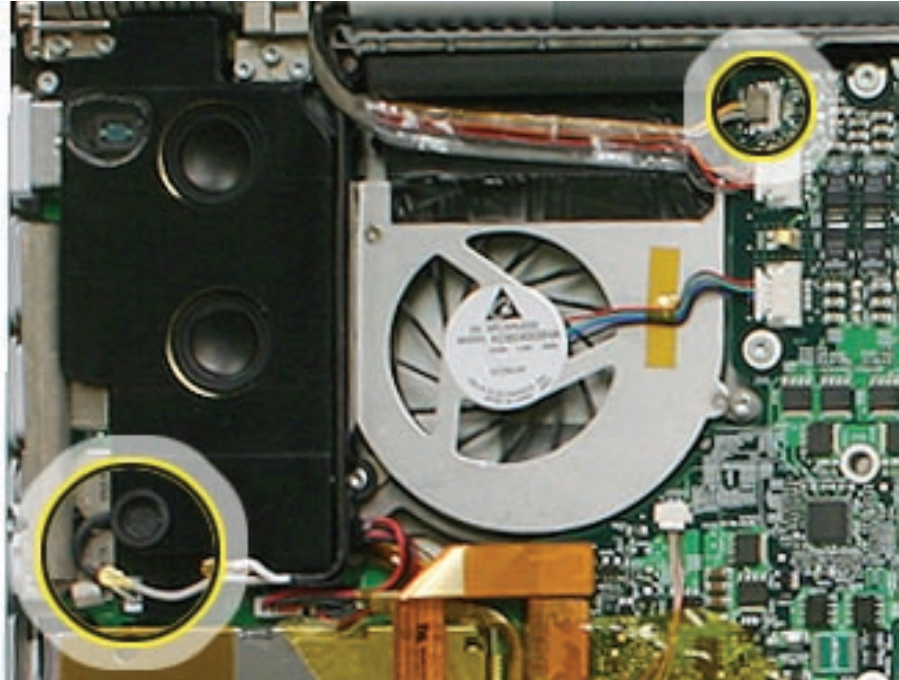

## Hardware Diagnostics

AppleCare offers two diagnostics for MacBook Pro. Apple Hardware Test (AHT) is shipped with every machine and targeted for end-users to troubleshoot their machine. Apple Service Diagnostics (ASD) is offered to Service Providers for more in-depth troubleshooting.

Both applications are available for download from Knowledge Base article 112125: **Service Diagnostics Matrix**. <http://docs.info.apple.com/article.html?artnum=112125>

Apple Hardware Test (AHT) 3A105 for MacBook Pro (17-inch)

Apple Hardware Test (AHT) 3A115 for MacBook Pro (17-inch Core 2 Duo)

### Notes:

- AHT 3A105 and 3A115 are not backwards compatible with previous Macintosh PowerPC-based notebook computers.
- Starting with MacBook Pro, the Apple Hardware Test version numbering changed. All Apple Hardware Tests will be number sequentially starting with the prefix "3A." This approach will provide each AHT release a unique version number and eliminate confusion between the same version across different product lines.

---

**AHT on the DVD follow these steps:**

1. Insert the DVD named “MacBook Pro Mac OS X Install Disc 1” that came with your computer.
2. Hold down “D” and restart the computer.
3. Follow the on-screen instructions.

**Note:** Previously, the option key was held down to boot into a boot manager. You are no longer able to see the AHT volume using boot manager.

Apple Service Diagnostic (ASD) 3S108 for MacBook Pro (17-inch)

Apple Service Diagnostic (ASD) 3S109 for MacBook Pro (17-inch Core 2 Duo)

**Notes:**

- ASD 3S108 and 3S109 are not backwards compatible with previous Macintosh PowerPC-based notebook computers.
- Some older diagnostics are not on the 3S109 disk. Please keep a copy of the 3S108 disk.
- Starting with MacBook Pro, like AHT, the Apple Service Diagnostic version numbering changed. All ASD will be number sequentially starting with the prefix “3S.” This approach will provide each ASD release a unique version number and eliminate confusion between the same version across different product lines.

---

## Troubleshooting Aids and Tips

### Power Button pads on logic board

With the top case removed, the power button is disconnected. Instead of having to reconnect the top case to turn on the system, there are two pads on the logic board that can be shorted across (with a tool like a flat blade screwdriver) to act as the power button.

These pads are located near the left side of the LVDS cable connector on the logic board. It is marked PWR BTN. The pads are separated with a vertical white line.

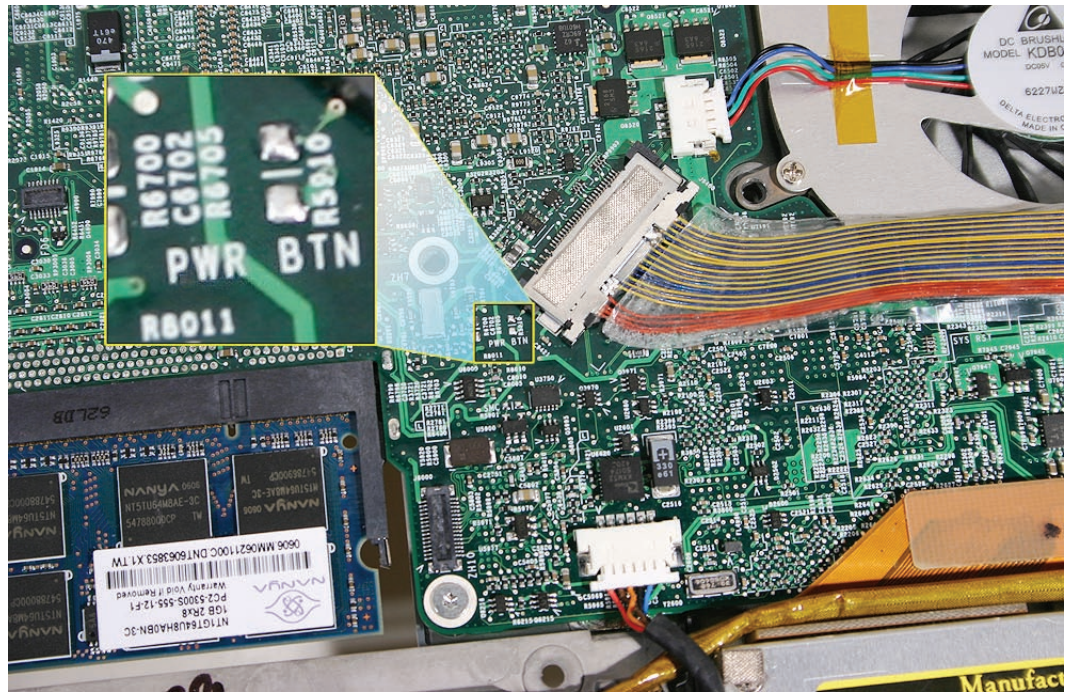

### Resetting the System Management Controller (SMC)

Power management is now handled by a chip called SMC (System Management Controller). Previously, it was handled by the Power Management Unit (PMU). To reset the SMC:

1. If the computer is on, turn it off.
2. Disconnect the power adapter and remove the main battery.
3. Hold the power button down for five seconds, then release.
4. Install the main battery and connect the power adapter.
5. Press the power button to restart the computer.

---

## Display off and sleep LED on

A new state was added to the sleep LED. When the system is running but the video is not turned on (for example, briefly upon boot, or when energy saver turns off the video but does not put the system to sleep), the sleep LED will light up uninterrupted. This feedback is to help avoid a customer's thinking the system is shutdown. It is possible, however, that this signal may fail if the system has crashed. As such, you can also use the next test to see if power is present to an apparently "off" system.

## System powered test using Caps lock LED

There are situations when the system is giving indications that it is shut down (no sleep light, no hard drive access, screen is dark, no fan, and so on); however, the logic board may still be running. In this case, the logic board is drawing power and generating heat.

**Warning: In this situation, if the computer is placed in an enclosed environment like a carrying bag, the computer can overheat.**

Check this situation by pressing the caps lock key. If the LED glows, the System Management Controller is running on the logic board. If instead, pressing the caps lock key and perhaps other methods of waking up the machine have failed, including closing the lid to put it to sleep and reopening it to wake it, hold the power button down for six seconds to force a shut down of the computer. Restart the system to check if it boots up normally.

**Note:** Previously when the keyboard was connected directly to the System Management Controller, this method worked under all conditions; however as a USB device, the OS may be hung and the keyboard cannot respond. So if the caps lock light does not come on, the computer may be drawing power. If in doubt, hold the power button down for six seconds to force a shut down of the computer.

---

## Software Troubleshooting Tips and Tools

All MacBook Pros require an Intel-compatible Mac OS.

- For the MacBook Pro (17-inch), use Mac OS X 10.4.6 or later only.
- For the MacBook Pro (17-inch Core 2 Duo), use Mac OS X 10.4.8 or later only.

### Login window and account

Mac OS X requires at least one user account to be established. This is the Administrator's account. By default, the Accounts system preference pane has the "Log in automatically [Admin's name]" checked. This automatic login setting allows the system to boot into the Finder without having a login prompt. However, if this box is not checked, you will need a password to get to the Finder. In addition, you will need to create a user account after you reinstall system software.

### Customer forgot password

If the customer forgot the password for the computer:

1. Insert the MacBook Pro Mac OS X Install Disc 1 DVD.
2. Restart the computer while holding down the C key on the keyboard.
3. When the installer appears, choose Reset Password under the Installer Utilities menu.
4. Follow the on-screen instructions.

### Safe Mode

Safe Mode is the state Mac OS X is in after a Safe Boot. A Safe Boot is a special way to start Mac OS X when troubleshooting. Starting up into Safe Mode does five things to simplify the startup and operation of your computer:

1. It forces a directory check of the startup (boot) volume. It is identical to using Disk Utility's Repair Disk or the `fsck -fy` terminal command.
2. It loads only required kernel extensions (some of the items in `/System/Library/Extensions`).
3. It disables all fonts other than those in `/System/Library/Fonts`.
4. It moves to the Trash all font caches normally stored in `/Library/Caches/com.apple.ATS/(uid)/`, where (uid) is a user ID number such as 501.
5. It disables all startup items and any Login Items.

To start up into Safe Mode (to Safe Boot), do this:

1. Be sure the computer is shut down.
2. Press the power button.
3. Immediately after you hear the startup tone, press and hold the Shift key.  
**Note:** The Shift key should be held as soon as possible after the startup tone but not before.

- 
4. Release the Shift key when you see the gray Apple screen and progress indicator (looks like a spinning gear). During the startup, you will see “Safe Boot” on the Mac OS X startup screen. To leave Safe Mode, restart the computer normally, without holding any keys during startup.

### Knowledge Base Articles

These troubleshooting articles can be searched from <http://www.apple.com/support>.

107392 [What is Safe Boot, Safe Mode?](#)

107394 [Safe Boot Takes Longer Than Normal Startup](#)

106692 [Mac OS X: Troubleshooting Installation and Software Updates](#)

106693 [Mac OS X: Troubleshooting Installation From CD-ROM](#)

## Application compatibility

With the transition to Intel microprocessors, previous applications written for the PowerPC microprocessor have to be re-compiled to be able to work directly with this new microprocessor chip. As with other microprocessor transitions, Apple has formed bridges for users and developers to aid in the changes—Universal binary and Rosetta.

### Universal binary

Universal binary is a Mac OS X application created by a developer who modifies and recompiles an application so it runs natively on either a PowerPC-based or Intel-based Mac. This application can run on older systems and the new MacBook Pro.

A Universal binary application can work directly with the Core Duo microprocessor. As discussed in the following section, older non-native PowerPC applications can still run on MacBook Pro, but requires a Mac OS X technology called Rosetta to translate for the Core Duo processor.

Universal binary applications are marked with the following logo:



### Rosetta

Rosetta is a Mac OS X technology which allows PowerPC applications to run on an Intel-based Mac. Rosetta works behind the scenes to translate an existing, native, non-Universal application (one that was designed to run natively a PowerPC-based Mac, not a Classic application—see note) so it can run on an Intel-based Mac—all you have to do is double-click the application!

---

**Note:** The Classic (Mac OS 9) application will not run on MacBook Pro. Recommend to customers that they upgrade to Mac OS X versions of required applications.

**Knowledge Base Articles**

These troubleshooting articles can be searched from <http://www.apple.com/support>.

303207 [Intel-based Mac: How to tell if an application is Universal](#)

303120 [Intel-based Mac: Forcing a universal application to run with Rosetta](#)

303137 [Intel-based Mac: Do Classic applications work?](#)







# Hardware Symptoms

## How to Use the Symptom Charts

The Symptom Charts included in this chapter will help you diagnose specific symptoms related to the product.

In this release, a section is dedicated to the normal startup of the Intel-based MacBook Pro (17-inch and 17-inch Core 2 Duo), with a dedicated chart to identify and troubleshoot “no power, no video” and “power, no video” symptoms.

The steps to solve a symptom are listed sequentially. You might not need to perform every step before the symptom is resolved. Start with the first step, and then test for the symptom. If the symptom persists, replace any modules you removed, go to the next step, and test again. Continue down the list until the symptom is resolved.

## Startup

### Startup Sequence

The Intel-based MacBook Pro starts up very much like the previous professional Macintosh notebook computers. If power is available to the system, after pushing the power on button the system will start to boot up.

- The screen will stay dark. The sleep LED will glow solid. This will last a few seconds.
- As the system boots, a power-on self test (POST) will be performed. See Error Codes listed below for failure results.
- If the system is not muted, you will hear a boot beep. The backlight will turn on and the sleep LED will turn off.
- The screen is gray in color. The Apple logo will appear and then the turning gear will appear.
- The desktop pattern will show up, as well as the menu bar start populating.

### No Power, No Video

**The computer will not power on (no fan movement, hard drive spin up and display is not lit).**

1. Remove any connected peripherals and eject any ExpressCard.
2. Check that the battery has enough charge to start the computer by pressing the button next to the LEDs on the battery. At least one LED must light solid (not flashing).
3. Connect a known-good Apple 85W Portable Power Adapter and power cord or plug to a known-good power outlet; make sure the DC plug is properly inserted. The DC plug should light up, if not, replace left I/O board. If not go to the troubleshooting, MagSafe connector.

- 
4. Try powering up without the battery installed. If it boots, try a known-good battery. If it does not boot, replace the battery connector cable.
  5. Reset the System Management Controller. See new procedures under “Resetting the System Management Controller (SMC)” in the **General Info: [Troubleshooting Aids and Tips](#)** section.
  6. Boot up the system and check the sleep indicator. If it turns on solid and turns off, the main logic board is getting power and completing the boot cycle. If no video appears, there is an issue getting video to the display, or system software is corrupted. Try booting from the Mac OS X Install DVD. If the light does not turn off, the boot cycle is not being complete. This may be caused by the hard drive not being detected by the system, system software corruption, or possibly a hardware issue.
  7. Press Caps Lock key to see if the keycap LED comes on. If it does, hold the power button down for six seconds to shut down the computer and restart.
  8. If it still doesn't start, verify that the power button cable is connected properly to the top case flex cable assembly and that the flex cable is connected correctly to the logic board. If the power button is damaged or not functioning correctly, replace the top case.
  9. Disconnect the keyboard completely. Inspect the connectors. Restart with the keyboard disconnected.
  10. Remove any additional RAM.
  11. Try removing the AirPort Extreme card from its socket and start the computer. If it starts, shut it down and check the flex cable connector and the connector on the logic board and replace the damaged parts.
  12. Reseat these flex cables:
    - Left I/O flex cable
    - Hard drive flex cable (will boot to flashing folder if not connected or corrupt)
    - Optical drive flex cable
    - Trackpad flex cable
    - Display LVDS cable
    - Thermal sensor cables
  13. If the computer starts up, inspect the flex cable connector and its terminal on the logic board for damage and replace the damaged parts.
  14. Try known-good left I/O board.
  15. Replace logic board.

---

## Power-On Self Test (POST) Error Codes

The computer automatically performs a power-on self test when it is turned on after being fully shut down (not a restart). This section describes what to do if beeps are heard during the startup. When this occurs, the sleep LED will stay on, occasionally flashing.

MacBook Pro relies on a combination of tones and blinking sleep LEDs to display power-on self test (POST) error codes.

If the computer detects no SDRAM (Synchronous Dynamic Random Access Memory, also referred to as RAM), or the RAM installed does not meet the appropriate specifications, the screen will remain black but the power LED on the front of the computer will blink once per second to signal the error. This error condition may be due to physically damaged RAM, installing the incorrect type of RAM, or not having RAM installed.

Some RAM may appear to pass the power-on self test (POST) but still cannot be used by the operating system. In this case, the computer will display a gray screen, sound three tones and blink the power LED on the front of the computer three times, pause, and repeat the blinking until the computer is turned off.

### Related Knowledge Base articles:

303083: [Intel-based Mac Power On Self Test RAM error codes](#)

303363: [Intel-based Mac: Startup sequence and error codes, symbols](#)

Blue screen appears (a spinning disc cursor may also be visible), Prohibitory Sign appears (a), Kernel Panic dialog box appears (b), or Gray screen during startup

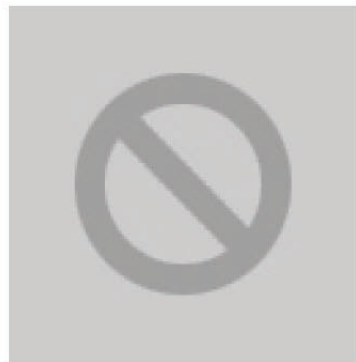

a) Prohibitory sign



b) Kernel panic dialog box

1. Make sure all external devices are disconnected and any ExpressCard ejected. If the kernel panic goes away, troubleshoot the external device by reconnecting each device until the panic occurs.
2. If there are two RAM cards installed in the expansion slots, remove the top card and restart.
  - If symptom repeats, replace bottom card with known-good RAM card.
  - If symptom does not repeat, replace top RAM card with known-good RAM card and restart.

---

For assistance in software troubleshooting, go to Knowledge Base article 106464: [Mac OS X: Troubleshooting a Startup Issue](#).

Flashing question mark appears on the screen

**Note:** This system will only boot the Mac OS X system that shipped with this computer or later. It does not support booting into Mac OS 9.

1. Start up from the MacBook Pro Mac OS X Install Disc 1 DVD that came with the computer (hold down the “C” key during restart) to run Disk Utility.
2. When the Installer opens, select **Disk Utility** from the Installer menu under Utilities.
3. In Disk Utility, you will see all available disk and volumes listed on the left hand side. If you don’t see the internal hard drive, the system is not recognizing it. Skip to the next step. Otherwise, select the internal hard drive icon and follow the instructions under the First Aid tab to verify the hard disk, and repair it if needed. Restart the computer.
4. If Disk Utility is unable to repair a persistent directory issue or corrupt file information, consult the following articles for possible solutions:  
106214: [Using Disk Utility and fsck to resolve startup issues or perform disk maintenance](#)  
25505: [Directory Issue Verification or Repair Is Not Part of Installation](#)  
25770: [Handling “overlapped extent allocation” errors reported by Disk Utility or fsck](#)  
302411: [Disk Utility reports “Underlying task reported failure” when repairing a volume](#)
5. If the hard drive is not recognized, check the hard drive flex cable for damaged connectors (a connector peeled off the flex cable, for example), and if bad replace the hard drive flex cable.
6. Reseat the hard drive flex cable. If still not recognized, replace the hard drive.  
**Important:** If the computer is under warranty and data recovery is required, refer to Knowledge Base article 31077: [DriveSavers: Hard Drive Data Recovery & Warranty Implications](#) for important information.
7. Reinstall system software using the MacBook Pro Mac OS X Install 1 disc.  
**Note:** Don’t forget to install both the Mac OS X system and application software.

For assistance in software troubleshooting, go to Knowledge Base article

88410: [SMART: A Brief Description](#)

152349: [Mac OS X 10.3: Replacing a disk before it fails](#)

Computer begins to power up, the fans and hard drive are spinning, pressing caps lock key lights LED, but there is no startup chime or video

1. Reset the System Management Controller. See new procedures under “Resetting the System Management Controller (SMC)” in the **General Info:** [Troubleshooting Aids and Tips](#) section.
2. Try connecting an external display to check for video signal that is not being displayed on the LCD. If no external video appears, skip to step 4 below. Otherwise proceed to step 3.
3. Check all cable and flex connections to the logic board. Try restarting.
4. Replace the logic board.

---

## System shuts down intermittently

1. Disconnect all external peripherals and eject any ExpressCard.
2. Make sure a known-good fully charged battery is fully inserted. Check that the battery latch is fully engaged and is not broken or getting caught before fully catching. Check battery connection to logic board.
3. Make a visual inspection of the battery connector in the battery bay. Make sure all blades are visible and not bent. If damaged replace the battery connector.
4. Make sure the system is not overheating, the air vents are clear and the unit was not used on a soft surface.
5. Make sure all feet are still on the bottom case. If not, order foot replacement kit.
6. Check that the fan cables are connected and the fans are operational.
7. Remove the battery and connect known-good 85W power adapter and power cord or plug to a known-good power source; make sure the DC plug is properly seated. The DC plug should light up. If not, consult the MagSafe power adapter troubleshooting section.
8. Verify that both thermal sensors are well seated and there is no damage to the cables.
9. Verify that the left I/O board cable is securely connected and shows no signs of wear.
10. Try known-good left I/O board.
11. Check that thermal material between the heat exchanger and logic board is in contact by unscrewing the logic board screws and gently pulling up on the left side of the board to verify resistance caused by adhesion from the thermal material. If not, reinstall new thermal materials for the processor, control ASIC, and video chip (see Logic Board Takeapart chapter).
12. Replace the logic board.

## System shuts down almost immediately after startup

1. Disconnect all external peripherals and eject any ExpressCard.
2. Make sure a known-good battery is fully inserted. Check battery charge and make sure that at least two LED charge indicators light up, otherwise connect the adapter. The adapter should light when plugged in. If not, consult the MagSafe power adapter troubleshooting section for further troubleshooting.
3. After charging for a while, if the battery does not seem to charge, or if it is charged up but quickly discharges, replace the battery. Verify with a known-good battery.
4. Check battery connection to logic board, and check wire attachment to connectors.
5. If just before the system shuts down, the sleep LED briefly comes on, check the two thermal sensor connections to the main logic board. They should be fully seated with no damage to the wiring. If the thermal sensor is damaged, replace it.
6. If a known-good battery does not charge, replace the left I/O board.
7. Replace the logic board.

---

## Application Quits, Kernel panic or other booting problems

1. If a specific application quits, replace the application. Verify the application is compatible with OS X.
2. Clear parameter RAM (PRAM). Hold down Command-Option-P-R during startup until you hear a second startup chime. For more information, consult Knowledge Base article 2238: [Resetting your Mac's PRAM and NVRAM](#).
3. Run Disk Utility from the Software Install and Restore DVD.
4. Perform a clean install of system software with the software install and restore disc that came with the computer. Note: Restore disc images are available at <http://service.info.apple.com>. Select "Disc Images."
5. Reboot system.
6. Run Apple Service Diagnostic (ASD) in loop mode (Control-L) for an extended time to test the memory. If the test finds bad memory, replace the DIMMs one at a time and test until all bad DIMMs are replaced with known-good modules.
7. Replace the logic board.

## AirPort Extreme

**Note:** The AirPort Extreme card is now separate from the Bluetooth module. In addition, the AirPort antenna is now in the clutch barrel behind the gray plastic window. The Bluetooth module and antenna are now mounted underneath the top case.

### AirPort Extreme not recognized

1. In Mac OS X, use Software Update in System Preferences or see the Apple Software Updates web page to make sure the latest version of AirPort Extreme software is installed.
2. Restart the computer.
3. Open AirPort in System Preferences and make sure AirPort is on and Base Station is selected.
4. Reseat the AirPort Extreme card in its slot.
5. Remove and reinstall the AirPort Extreme software.
6. Replace with known-good AirPort Extreme card.
7. Replace left I/O board.
8. Replace the main logic board.

### AirPort connection is slow

1. Move computer closer to AirPort Base Station or other AirPort device.
2. Check the number of users trying to use AirPort in the area. Too many users may be accessing the network at the same time, causing heavy network traffic. To improve network

---

connection speed, add additional AirPort Base Stations.

3. Check for other changes in the environment that may cause interference with the AirPort signal. For more information, consult Knowledge Base article 58543: [AirPort: Potential sources of interference](#).
4. Use Software Update in System Preferences or see the Apple Software Updates web page to make sure the latest version of AirPort Extreme software is installed.
5. Restart the computer.
6. Check the AirPort Extreme antenna connection to the AirPort Extreme Card.
7. Reseat the AirPort Extreme card in its slot.
8. Replace with known-good AirPort Extreme w/ Bluetooth card.
9. Check AirPort Extreme antenna wires coming from clutch barrel for nicked insulator or crimped wire. If bad, replace the AirPort Extreme antenna in the clutch barrel.
10. Replace left I/O board.
11. Replace the main logic board.

## Battery

### Battery will not pop up

1. Flip over the unit and slide the battery latches.
2. If the battery does not pop up, use a small plastic flat-blade tool to pry up the battery around the battery latch.
3. Try a new battery.
4. Verify proper latch operation, by exercising the latch. If it does not move smoothly or evenly, replace the bottom case.
5. If the latch does exercise correctly, verify that the customer is not installing the battery with excessive force or the body of the battery has not been deformed around its perimeter.

**Warning: If the battery plastic housing has been damaged, or the two halves of the housing have separated, the battery is unsafe for use.**

**Note:** If there is no sign of abuse (dents, scratch marks) replace the battery under warranty.

### The battery won't charge

1. Remove any externally connected peripherals.
2. Try known-good power outlet.
3. Connect known-good MagSafe 85W power adapter and power cord or plug; make sure the DC plug is properly inserted. The DC plug should light up. If not, troubleshoot the MagSafe connection and power adapter. If the power adapter light is green, turn over the computer and press the battery button. The battery lights should glow green and stay on if the power

---

adapter is operating correctly.

4. Try a known-good battery. If it charges, replace the battery. If doesn't charge, check the battery connector and its connection to the logic board.
5. Replace the battery connector assembly (requires removing the logic board).
6. Reset the System Management Controller. See new procedures under "Resetting the System Management Controller (SMC)" in the **General Info:** [Troubleshooting Aids and Tips](#) section.
7. Make sure the left I/O cable is firmly connected. Look for damaged insulation or wires.
8. Replace left I/O power cable.
9. Replace logic board.

### Battery won't charge completely

If the battery appears to stop charging between 95 and 99 percent, this is normal operation. Refer to Knowledge Base article 88344: [PowerBook G4, iBook: battery does not show full charge in Mac OS X](#).

### Short battery life

Three categories to consider:

- There is a system issue (not the battery).
  - If you have the customer's power adapter, plug it into a known good outlet and verify that it can charge the system. Also make sure it is the correct 85W adapter.
  - Plug a known good 85W adapter into a known good outlet. Verify that the DC connector is fully seated into the computer.
  - Check whether the customer's system is setup for heavy battery power use (AirPort on, optical media always in drive, Energy Savings set to Highest Performance, etc.)
  - Test the computer with all third-party devices (printers, hubs, third-party keyboard or mouse) removed.
  - Reset the System Management Controller. See new procedures under "Resetting the System Management Controller (SMC)" in the previous chapter, **General Info:** [Troubleshooting Aids and Tips](#) section.
- The battery needs calibration, or it is nearing the end of its useful life.
  - Calibration should be done when you first use the battery, and every few months after. It allows the battery to properly calculate how much power is left in the battery.
  - The battery is a consumable part. It can be charged and discharged only so many cycles before it becomes depleted and can no longer hold a charge.
  - **Note:** The battery calibration procedure is as follows:
    1. Plug in the power adapter and fully charge your battery until the light on the power adapter plug changes to green and the onscreen meter in the menu bar indicates that the battery is fully charged.
    2. Allow the battery to rest in the fully charged state for two hours or longer. You may use your computer during this time as long as the adapter is plugged in.



- 
3. Disconnect the power adapter with the computer on and start running it from the battery. You may use your computer during this time. When your battery gets low, you will see the low battery warning dialog on the screen.
  4. Continue to keep your computer turned on until it goes to sleep.  
**Note:** Save all your work and close all applications when the battery gets low, *before* the system goes to sleep.
  5. Turn off the computer or allow it to sleep for five hours or longer.
  6. Connect the power adapter and leave it connected until the battery is fully recharged again.
- The battery has a defect.
    - Symptoms include, but are not limited to, a relatively new battery that will not charge at all, reports an “X” in the menu bar icon, or status light on its case that will not go out. In the first two cases, the battery may need calibration—try this first. In addition, after troubleshooting at the system level, if it is demonstrated that the battery is causing abrupt shut-downs or goes to sleep without warning, the battery can be considered severely degraded and follow the criteria below.
    - **Warranty Note:** If the battery was purchased (either with the computer or as a standalone part) in the last 90 days and exhibits severely degraded performance (as defined above) provide an in-warranty replacement. If the battery was purchased between the last 90 to 365 days, have the customer calibrate their battery. If after recalibration, the battery still exhibits severely degraded performance, then provide an in-warranty replacement. If the battery was purchased more than 365 days ago, the customer will need to purchase a new battery.

**Useful Knowledge Base articles:**

86440: [PowerBook, iBook: Battery Life, for tips on extending battery life and explanations of some concepts of battery use.](#)

86284: [Calibrating your computer's battery for best performance](#)

304301: [MacBook and MacBook Pro: Battery not recognized after being fully drained](#)

## Bluetooth

Bluetooth system preference pane does not show up under hardware section of System Preferences

1. Check for software/firmware updates on the web.
2. Check the Bluetooth card flex cable underneath the top case. Make sure the cable is not damaged and is fully seated.
3. Check the Bluetooth flex connection to the trackpad flex.
4. Check the top case flex connection to the main logic board.
5. Replace the Bluetooth card.
6. Replace the top case.

- 
7. Replace the logic board.

### Bluetooth card not recognized by other devices

1. Open Bluetooth in System Preferences and make sure that Discoverable is checked under the Settings tab.
2. Make sure the Bluetooth antenna is properly installed.
3. Check the Bluetooth antenna is connected to Bluetooth card.
4. Replace with known-good Bluetooth card.
5. Replace the top case.
6. Replace logic board.

## Display

### Display latch not working

**Note:** When the display is being closed, two latch hooks in the top of the display housing should be magnetically pulled down through the slots in the top case and secured by the latch mechanism. When the latch button is pushed, the hook should release and retract into the display housing.

If the latch hook is broken, replace the display latch hook assembly.

### When displaying a single color over the screen area, the LCD panel shows one or more pixels that are not properly lit

To determine whether or not the display has an acceptable number of pixel anomalies, follow the steps below:

1. Set the display image to one of the following colors: all-white display, all-red display, all-green display, or all-blue display. Knowledge Base article 112125: [Service Diagnostics Matrix](#), has the LCD Tester Diagnostic Utility that will generate these patterns on the screen.
2. Using a jeweler's loupe, pocket microscope, or other magnifying device, identify and count each pixel anomaly:
  - Bright subpixel anomaly = subpixel that is always on
  - Dark subpixel anomaly = subpixel that is always off
3. The number of acceptable pixel anomalies for this system is:

#### Acceptable Number of Subpixel Anomalies

Bright	Up to 3
Dark	Up to 5
Combination	Up to 7

- 
- If the number of subpixel anomalies exceeds the acceptable number listed in the above chart, replace the display panel assembly.

### Replace

Bright	4 or more
Dark	6 or more
Combination	8 or more

- If the number of subpixel anomalies is acceptable, explain to the customer that the pixel anomalies are within specifications, and no repair is necessary.

**Important:** Do not release the specifications to customers. Instead, inform them that a certain number of subpixel anomalies are considered acceptable, and these factors apply to all manufacturers using LCD technology—not just Apple products.

When speaking with customers, please use the following explanation:

Active-matrix LCD technology uses rows and columns of addressable locations (pixels) that render text and images on screen. Each pixel location has three separate subpixels (red, green, and blue) that allow the image to be rendered in full color. Each subpixel has a corresponding transistor responsible for turning the subpixel on or off.

There are typically millions of these subpixels on an LCD display. For example, the LCD panel used in the Apple Cinema HD display is made up of 2.3 million pixels and 6.9 million red, green, and blue subpixels. Occasionally, a transistor does not work perfectly, which may result in the affected subpixel being turned on (bright) or turned off (dark). With the millions of subpixels on a display, it is quite possible to have a low number of faulty transistors on an LCD. Therefore, a certain number of subpixel anomalies are considered acceptable. Rejecting all but perfect LCD panels would significantly increase the retail price for products using LCD displays. These factors apply to all manufacturers using LCD technology—not just Apple products.

## ExpressCard/34

### ExpressCard will not insert into the ExpressCard slot

- Make sure the ExpressCard is 34mm in width. The ExpressCard standard allows for 54mm cards which will not fit in this slot.
- Make sure the ExpressCard is right side up (cards are keyed and cannot be inserted upside down).
- Verify the ExpressCard is not warped or damaged in any way; if so replace the card.
- Try a different ExpressCard.
- Carefully raise the ExpressCard slot cover and check for a foreign object inside the slot.
- If the slot cover is preventing the card from being inserted, re-seat the ExpressCard on the left I/O board by making sure the cage is closer to the main logic board. The door catch on

---

the top of the ExpressCard mechanism.

7. Reseat the ExpressCard cage.
8. If the ExpressCard cage is damaged, replace it.
9. Replace the left I/O board.

### ExpressCard does not mount to the desktop

1. Make sure the ExpressCard has its drivers installed.
2. Check if a known-good ExpressCard works in this slot. The ExpressCard may be bad.
3. Check the left I/O Board flex cable connection to the logic board.
4. Try inserting the card without the ExpressCard cage installed on the left I/O board. If the card is recognized, reinstall the ExpressCard cage with the card in place.
5. Replace the ExpressCard cage.
6. Replace the left I/O flex cable.
7. Replace the logic board.

## Hard Drive

### Internal hard drive will not initialize:

1. Make sure the hard drive is a cable select drive set as a master (0).
2. Start up from the MacBook Pro Mac OS X install Disk 1 disc that came with the computer (hold down the "C" key during restart).
3. When the Installer opens, from the Installer menu, select Open Disk Utility.
4. If the hard drive is recognized, format it under the Erase tab.

To format a blank hard drive:

- Boot from the MacBook Pro Mac OS X Install Disc 1 which came with the system (hold down "C" key while booting).
- Select the desired language.
- Select Disk Utility, under the Utilities menu.
- Click the Erase tab.
- Select the hard drive in the Source pane.
- Verify that Mac OS Extended (Journaled) is selected.
- Click Erase.

Continue using the MacBook Pro Mac OS X Install Disc 1 to install the system software.

Restart the computer and run Software Update and install updates. Continue to run Software Update until no more updates are listed.

**Important:** If the computer is under warranty and data recovery is required, refer to Knowledge

---

Base article 31077: [DriveSavers: Hard Drive Data Recovery & Warranty Implications](#), for important information.

## Apple Remote

Remote won't communicate with system applications such as iTunes or iPhoto, or with the optical drive.

Make sure of the following when using the (infrared) Apple Remote:

- You are within 30 feet of the front of the computer.
  - You have an unobstructed line-of-sight to the front of the computer.
  - You are pointing the lens end of the Apple Remote directly at the front of the computer.
  - The computer is powered on and awake.
  - The "Disable remote control infrared receiver" checkbox in the Security pane of System Preferences is NOT checked.
1. Make sure the active application works with Apple Remote. Apple Remote uses Front Row, and from Front Row it can access DVD Player, iPhoto, iTunes, and QuickTime Player.
  2. Make sure the remote is paired with the computer. Access the System Preferences/Security pane and check "Unpair" if available. Close the Security pane, and re-pair the Apple Remote with the computer. See Knowledge Base article 302545.:
  3. Use a digital camera to test your Apple Remote.  
If you have a digital camera or DV camera with an LCD display, you can use it to see if your Apple Remote is emitting a signal. Infrared beams are invisible to the human eye, but most digital cameras and video cameras use Charged-Coupled Device (CCD) chips or image sensors that are sensitive to infrared light.  
To use a camera to test your Apple Remote, follow these steps:
    - Turn on your digital camera or DV camera and remove any lens cover.
    - Point your Apple Remote toward the display latch button.
    - Press and hold the Menu button on the remote while looking at your camera's LCD display.
    - If you see a faint blinking light coming from the Apple Remote in the camera's LCD, then the remote is working properly.
    - If you don't see any blinking light in the camera's LCD, replace the battery in your Apple Remote and then test it again with your computer
  4. Replace Apple Remote battery. See Knowledge Base article 302543: [How to replace the Apple Remote battery](#).
  5. Replace Apple Remote.

## Infrared Board

Supported applications do not respond to input from the remote control.

1. Make sure "Disable remote control infrared receiver" checkbox is not checked.

- 
2. If “Unpair” is available in the Security pane of System Preferences, another Apple Remote may be paired to the computer (pairing allows only one Apple Remote to control the computer). To delete a pairing between the remote and the MacBook Pro, click Unpair. (You may have to enter your Administrator password to make changes in the Security pane.) For further instruction, consult Knowledge Base article 302545: [Pairing your Apple Remote with your computer](#).
  3. Perform the checks above under “Apple Remote” to verify that the Apple Remote is functioning correctly, and retest.
  4. Check that the infrared board cable is connected to the hard drive flex and infrared board.
  5. Verify that the infrared sensor can be seen in Apple System Profiler. Open Apple System Profiler and click on “USB” section. If you don’t see it, replace the infrared board and retest.
  6. Replace the hard drive flex and retest.
  7. Replace the logic board.

## Built-in iSight Camera

The built-in camera is not recognized.

1. Boot the MacBook Pro to the desktop and launch iChat AV. Note: You do not need to be connected to a network to use iChat AV to troubleshoot. Verify that the correct versions of Mac OS X and iChat AV are installed. Reinstall or update software as needed.
2. Open the iChat AV preferences and click on the ‘Video’ icon. Verify whether the camera is recognized by the iChat AV software. Is the camera recognized?
3. Check the camera connection to main logic board.
4. Check the camera connection to the camera board (in the display assembly).
5. Replace the display assembly.

### Camera image quality poor

- Verify that the lens assembly for the iSight camera is clean. Fingerprints and other contaminants can affect image quality. Clean the lens using a lint free lens cleaning cloth being while being careful not to scratch the lens. Verify that there is sufficient lighting to produce a good quality image.
- Lighting which is comparable to that found in a well lit office will product a good quality image. If possible, avoid having a brightly lit background. Diffused lighting is preferred over direct lighting. Launch iChat AV and open the iChat AV preferences. Click on the ‘Video’ tab. Is the video quality acceptable?

**Yes:** The camera is functioning normally. The image quality problems may be caused by bandwidth limitations when using iChat over the internet. Instruct the customer to use the iChat AV connection doctor feature to verify that there is sufficient bandwidth to have a video iChat session without a significant degradation of image quality.

---

**No:** The camera may not be functioning normally. Replace display assembly and retest.

### Camera recognized but no audio

1. Open the System Preferences window and click on Sound. Verify that the built-in internal microphone has been selected as the device for sound input. Verify that the volume settings (on the slider bar) are appropriate.
2. Launch iChat AV and open the iChat AV preferences. Click on the 'Video' icon. Speak into the microphone while monitoring the microphone level indicator. If line meter responds, it was a settings problem.
3. Check that the microphone is plugged in.
4. Replace the microphone assembly.

### The camera is recognized but the built-in microphone's audio quality is poor.

1. Open the System Preferences window and click on Sound.
  - Verify that the internal microphone has been selected as the sound input port.
  - Verify that the input volume settings are appropriate. Use the volume level meter to verify settings.
2. Open iMovie and create a new project. Click on the Audio button and record a sound sample. If audio quality is fine, it was a settings problem.
3. Check that the microphone is plugged in.
4. Replace the microphone assembly.

## Keyboard

### No response from keys on the keyboard

1. Remove any connected peripherals and eject any ExpressCard.
2. If only numbers show up, check if NUM lock (F6) is engaged.
3. Go to Apple System Profiler and look at the USB bus. If you see Apple internal keyboard / trackpad, go to step 6.
4. Attach an external USB keyboard. If it doesn't work, go to step 6.
5. Turn off the computer. Check the keyboard flex cable connection to the trackpad and the trackpad flex cable connection to the main logic board (especially check connectors for damage).
6. Start up from the MacBook Pro Mac OS X Install 1 DVD that came with the computer (hold down the "C" key during restart, if possible) to verify that it is not a software problem.
7. Replace keyboard.

- 
8. Replace top case.
  9. Replace logic board.

### No keyboard illumination

1. Go to the Keyboard system preference pane and make sure the “Illuminate keyboard in low light conditions” check box is checked. Cover the left and right speaker grills with your hands.  
**Note:** The keyboard illumination is not bright enough to be seen in most well lit spaces. In order to view the keys being illuminated, the ambient light needs to be dim.
2. Check the keyboard backlight flex cable connection to the top case flex cable.
3. Replace keyboard.
4. Replace top case.
5. Replace the left ALS board.
6. Replace logic board.

### Keyboard is partially illuminated.

1. Check the keyboard backlight cable connection to the top case flex.
2. Replace keyboard.
3. Replace top case.

## Microphone

### The microphone is not working

1. Check the Sound system preference pane and verify that the selection under the Input tab is for the built-in microphone.
2. Check the signal level and level meter and adjust the gain.
3. Reset PRAM (shutdown the computer, press the power button, then hold down the Option-Command-P-R keys simultaneously until you hear the startup chime at least one additional time after the initial startup chime).
4. If there is no sound output from the internal speaker nor is the microphone working, verify cable connections.
5. Replace the microphone assembly.
6. Replace left I/O flex cable.
7. Replace the left I/O board.
8. Replace the logic board.



---

## Modem (External)

**Note:** MacBook Pro does not have a built-in modem. Apple offers an optional external USB Modem.

### No modem dial tone

1. Check that the correct modem is selected in the Network Port Configuration section of the Network system preferences.
2. Verify known-good analog (not digital) telephone line.
3. Verify known-good RJ-11 telephone cable.
4. Verify RJ-11 cable is not plugged into Ethernet port (should not be physically possible with this MacBook Pro).
5. Verify RJ-11 telephone cable is firmly installed in the modem port.
6. Inspect RJ-11 connector for pin damage. If damaged, replace modem.
7. Open Apple System Profiler, and under the Hardware tab look at USB . It should show the modem presence by indicating Apple External Modem.. If not visible, start checking modem USB connection.
8. Update system software.
9. Try a known-good Apple USB modem in all USB ports. If it does not work in either of the two left USB ports, replace the left I/O board. If it does not work in the right USB port, replace the logic board.

### Modem does not respond (can hear dial tone)

1. Check that the correct modem is selected in the Network Port Configuration section of the Network system preferences.
2. Check that the modem application is properly configured.
3. Open Apple System Profiler, and under the Software tab look at Extensions. Check to see that the MotorolaSM56K and AppleI2SModem Family files are listed and loaded. If not, restart the system and check again. If still not visible, replace system software.
4. Open Apple System Profiler, and under the Hardware tab look at USB. It should show the modem presence by indicating Apple External Modem. If not, start checking the modem USB connection.
5. Replace Apple USB Modem.
6. Replace logic board.

### Modem intermittently disconnects or low performance

1. Verify known-good RJ-11 telephone cable (for example, the retaining clip is not broken off) and check that it is firmly installed when used. If telephone cable is bad, replace it.

- 
2. If the issue happens with only one particular phone line, but not another, the problem may be an issue with that particular phone line. Under bad line conditions, try setting the modem script to start with a slower connect rate such as "Apple Internal 56K Modem (v.34)."
  3. If the customer indicates the system disconnects under very high CPU loads such as burning DVDs and/or working with video editing software such as Final Cut Pro, try connecting the modem without any application running and see how the modem performs. Use Knowledge Base article 106642: [Mac OS X: Using Apple PPP Test Server](#) to test the modem. If OK, suggest to the customer to use the modem with less applications running simultaneously.
  4. Replace Apple USB modem.
  5. Replace the logic board.

## Optical Drive

### Optical drive not recognized

1. Make sure the optical drive is a cable select drive set as a slave (1).
2. Make sure the optical drive flex cable is undamaged and properly installed. If bad, replace.
3. Replace optical drive.

### The optical drive does not accept CD or DVD discs (mechanical failure)

1. Verify disc is not warped and is a 12 cm circular disc.
2. Check that a small disc is not stuck inside, or other foreign objects. Remove drive from system to extract disc.
3. Verify disc is pushed almost all the way into the slot.
4. Check that the optical drive flex cable is undamaged and properly installed. If damaged, try replacing the flex cable.
5. Replace optical drive.

### The optical drive does not eject CD or DVD discs

1. Verify disc is not in use by quitting any applications that may be using the disc.
2. Press and hold Media Eject key at top right corner of keyboard. If that does not work, hold down Function (fn) key and Media Eject key.
3. Drag disc icon to trash or select it and press Command-E.
4. Choose Restart from Apple menu while holding down trackpad button.
5. Reseat the optical drive mechanism. Make sure the drive is oriented toward the back of the computer, and that all four corners are seated, so that the drive sits flat in its bay.
6. Replace optical drive.

---

The disc icon does not show up on desktop, or a dialog box appears to initialize disc, when inserting a read-only disc

1. Verify the correct type of disc is being used.
2. Use Software Update system preference pane to check if there is updated firmware.
3. Try cleaning the disc. If it is dirty or scratched, it may not mount.
4. Try a different disc.
5. Replace optical drive cable.
6. Replace optical drive.

### Difficulty writing to optical media

1. Verify the correct type of disc is being used.
2. Try a different brand or speed of CD-R disc.  
**Note:** Some brands of 24x or 32x CD-R media may not work with the SuperDrive.  
**Note:** There are two factors in the ability for the optical drive to write to media.
  - First, there are varying qualities of blank optical media. Some media are made to such low specifications that the ability for the drive to write to it is marginal. There are variations in optical media even under the same brand. Some brands source their optical media from a variety of manufacturers, so there may be variations in the quality.
  - Second, an optical drive that supports writing to a CD-R/RW or DVD-R/RW disc requires a special writing algorithm for discs from different disc manufacturers. There are hundreds of disc manufacturers, it is impossible to implement writing algorithms for each disc manufacturer. Usually, drive manufacturers implement special writing algorithms for discs from major disc manufacturers. For discs that are not supported by the drive with special writing algorithms, the drive will use a generic writing algorithm to write the disc. In this case, the writability and readability may not be optimal.
3. Replace optical drive flex cable.
4. Replace optical drive.

## Ports

### A USB port is not recognizing devices

1. Shut down the computer; then press the power button to start the computer.
2. Use Software Update system preferences to verify that the latest software is installed.
3. For USB, test ports with an Apple keyboard or mouse. If the left port is not recognized check the left I/O flex cable's condition and connection.
4. If the left I/O flex cable is fine, replace the left I/O board for the left USB port. For the right USB port, replace the main logic board.
5. Use Apple System Profiler to verify that the computer is recognizing the bus. If not, replace

---

the logic board.

### A USB device not recognized by computer

**Note:** If you are trying to use a serial device with a USB/Serial adapter, check with the manufacturer of the adapter for compatibility.

1. Shut down the computer; then press the power button to start the computer.
2. Verify that the current driver for the device is installed.
3. If a camera, turn on camera after initiating download with camera application.
4. Try the other USB ports.
5. Try a different USB device on same port.
6. Eliminate chain by plugging in only one peripheral.
7. Try known-good Apple USB keyboard or mouse to verify the port is working properly. If the left port is bad, check the left I/O board flex cable and connections. If the right port is bad, check the backup battery flex cable and connections.
8. If the left I/O flex cable is fine, replace the left I/O board for the left USB port.
9. If the right port is bad, replace the main logic board.

### A FireWire port is not recognizing devices

**Note:** In FireWire Target Disk Mode, MacBook Pro cannot be mounted on systems with Mac OS X 10.3.9 or earlier. Refer to Knowledge Base article 303118: [Intel-based Macs: About using Target Disk Mode with Mac OS X 10.3.9 or earlier.](#)

1. Test the FireWire port by connecting to another computer using FireWire Target Disk Mode. Refer to Knowledge Base article 58583: [How to Use FireWire Target Disk Mode.](#)
2. Verify that drivers are installed properly for third party, if needed.
3. Make sure the cable is firmly attached.
4. Try a different cable.
5. If self-powered make sure that the power supply is connected and the device's LED indicates it is getting power.
6. Replace logic board.

## Power Adapter

### The power adapter LED does not turn on

1. Confirm the power adapter is connected to a known-good outlet.
2. Try replacing the AC plug or the AC power cord. If the adapter works replace the appropriate plug or cord.

3. Check the pins in the power adapter's DC plug for pins that are stuck down.

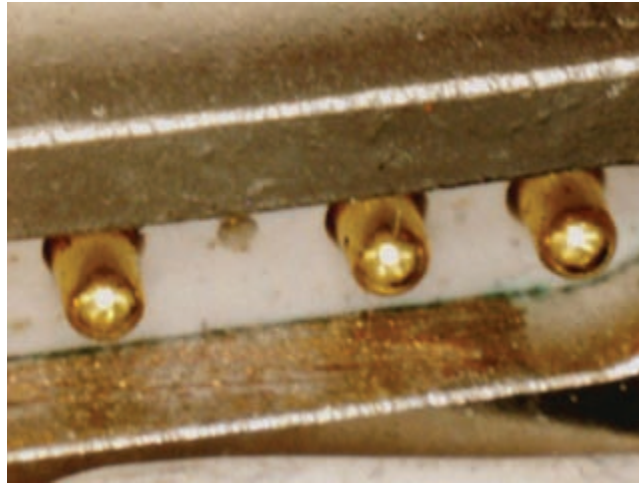

If pins are stuck down, try cleaning the contacts.

Debris removal should be done with a soft, non-electrostatic generating (non-plastic bristle) brush. A tool such as a cotton swab may introduce foreign material that will cause the pins to seize up. If the pin has become stuck, try working the pin to release it.

4. If the LED on the DC cord does not turn on, there may be contamination in the computer port. The contact pins can be dirty. It can be cleaned with a soft brush. Do not use liquid.

In addition, foreign material may be pulled in which covers the contacts or prevents the DC plug to seat enough for the sense pin to connect to the system.



5. Check if pins are missing or bent. Replace the power adapter
6. Check the power port on the computer for contamination which prevents the pins to make contact. It can be cleaned with a soft brush. Do not use liquid.
7. Remove the battery and connect the power adapter. If the adapter turns on and boots the system, replace the left I/O board.

---

## Sound

No sound is heard and the Speakers section of the Sound system preference pane indicates an external device is plugged in (to the headphone jack or USB ports)

1. If there is nothing plugged into the headphone jack or USB ports, under the Output tab of the Sound system preference pane should be set to the internal speakers.
2. If not, and if nothing is plugged in, try plugging in headphones or external speakers. Restart the computer. Remove the device.
3. Reset PRAM. (Press the power button, then hold down the Option-Command-P-R keys until you hear the startup chime at least one additional time after the initial startup chime).
4. If the system continues to indicate a phantom device is plugged into the system, replace left I/O board.
5. Replace logic board.

No sound from speaker(s)

1. Use Software Update to verify that the latest audio update has been installed.
2. Press the F3 key (with the fn key pressed and then not pressed) to verify that mute mode is not enabled.
3. Press the F4 or F5 key (with the fn key pressed and not pressed) to check the volume setting.
4. Verify that no external speakers or headphones are plugged in.
5. Check the speakers tab on the Sound control panel to confirm that the software is correctly seeing that there are no external speakers or headphones connected.
6. Shut down computer and restart.
7. Reset PRAM. (After restart, hold down the Option-Command-P-R keys until you hear the startup chime at least one additional time after the initial startup chime).
8. Verify that the speaker cable is connected properly to left I/O board.
9. Check speaker cable. Verify left and right cable connections.
10. Verify with headphones or external speaker. If audio is heard, replace speaker assembly.
11. Replace left I/O flex cable.
12. Replace left I/O board.
13. Replace the logic board.

Distorted sound from speakers

1. Verify sound is correct with external speakers/headphones. If sound is correct, check speaker wire and connections.
2. In Sound system preference pane, check balance.

- 
3. Compare same sound with two different units to make sure that sound is actually distorted.
  4. Check speaker wire. If damaged, replace speaker assembly.
  5. Replace left I/O flex cable.
  6. Replace logic board.

## Trackpad

### The cursor does not move when you are using trackpad

1. Verify that no USB device is connected.
2. Boot from the Software Install and Restore DVD to verify that it is not a software problem. If the trackpad works, restore the system software.
3. Reset the System Management Controller. See new procedures under “Resetting the System Management Controller (SMC)” in the **General Info:** [Troubleshooting Aids and Tips](#) section.
4. Check trackpad flex cable connection to the logic board.
5. Replace top case.
6. Replace logic board.

### The cursor intermittently does not move or moves erratically

#### Notes:

- User must touch with the surface of only one finger at a time and point directly down on the trackpad surface.
  - When running Apple Hardware Test or Apple Service Diagnostic, the trackpad will respond in very small movements of the cursor. This behavior is normal.
1. Clean trackpad surface (with computer off, using a non-static-inducing material).
  2. Completely shut down, then press the power button to start the computer.
  3. Reset the System Management Controller. See new procedures under “Resetting the System Management Controller (SMC)” in the **General Info:** [Troubleshooting Aids and Tips](#) section.
  4. Make sure power adapter is using the AC power cord, not the duckhead. If the intermittent behavior goes away, recommend using the AC cord to provide a ground path for static to go.
  5. Disconnect the power adapter, and run on battery power only. If problem goes away, replace power adapter.
  6. Place the MacBook Pro Mac OS X Install 1 Disc in the optical disc drive, press the start button and hold down the “C” key. Check the cursor movement, to see if the problem is software.
  7. Check trackpad flex cable connection to the logic board.
  8. Replace top case.
  9. Replace logic board.

---

## Video

### No display, or dim display, but computer appears to operate correctly

1. Remove any connected peripherals.
2. Make sure F1 key is not stuck down.
3. Press the F2 key (with the fn key pressed and not pressed) to increase the screen brightness.
4. Reboot the computer—hold down the Control and Command keys and press the Power button to restart the computer. Or press and hold the Power button for 5 to 10 seconds to shut down the computer, then press the Power button to restart. Let the system run for an hour, so the panel can warm up.
5. Try connecting an external display to check for intact video signal. If no external video appears, skip to step 10 below. Otherwise proceed to next step.
6. Verify inverter cable and LVDS cable connections are seated properly and that the cables are not damaged.
7. Replace inverter board.
8. Replace the display rear housing (which includes the inverter cable assembly, or replace separately if available).
9. Replace LCD panel.
10. Replace logic board.

### Computer appears to work, but there is no video on an external device connected to the S-video/Composite port of the optional DVI to Video Adapter

1. The device must be connected to the S-video/composite port while the MacBook Pro is sleeping or off for the device to be recognized.
2. Verify monitor that is used in testing is known-good and is supported by this computer.
3. Try different DVI-to-Video Adapter.
4. Replace logic board.

### No video on external VGA device connected to the external monitor (DVI) port

1. Verify monitor that is used in testing is known-good and is supported by this computer.
2. Try another DVI-to-VGA adapter cable.
3. Restart the computer and test again.
4. Replace logic board.

### No display, or dim display, but can display external video

1. Remove any connected peripherals.



- 
2. Try adjusting the brightness using the F2 function key.
  3. Open Display system preference panel and check brightness. If works, replace keyboard.
  4. Check connection of the inverter cable to the main logic board.
  5. Check inverter cable connection to the inverter board and the inverter to the LCD cable connection.
  6. Replace inverter board.
  7. Replace display rear housing (which includes the inverter cable assembly, or replace separately if available).
  8. Replace display assembly.
  9. Replace logic board.

#### Display has repetitive patterns or shifting color pattern

1. Check for the latest system software update.
2. Check the LVDS connection is fully seated on the logic board.
3. Replace the logic board.

#### Display has permanent vertical or horizontal lines.

1. Check for the latest System software update
2. Replace display panel.
3. Replace logic board.

### Misc. Symptoms

#### The Date and Time settings reset repeatedly

**Note:** Resetting the System Management Controller or PRAM resets the date and time. The MacBook Pro uses a non-rechargeable lithium battery.

1. Do a backup battery test:
  - Set the date and time.
  - Perform a Shut Down from the Apple menu.
  - Remove the main battery and disconnect the power adapter for 10 minutes.
  - Connect the power adapter, insert the battery, and power on the computer.
  - If the date and time were lost the backup battery may be dead or discharged.
  - Remove main battery from the unit and leave it plugged in for at least 5 hours.
2. Replace backup battery.
3. Replace the logic board.

---

## Feet came off the bottom case

Replace the missing foot or feet.

## Sleep LED does not come on when lid is closed

1. Put the computer to sleep using the menu option. If the sleep LED goes on, there is a problem with sensing the closed display. If the LED does not go on, skip to step 3.
2. With the display housing removed, check the sleep magnet location on the LCD panel: (See the LCD Panel chapter in the Take Apart section of this manual.)
  - If it is not positioned correctly, reposition it. Polarity makes a difference.
  - If the magnet is missing, replace it with a new magnet.
3. Check that the sleep LED is plugged into the logic board.
4. Connect a USB mouse. Short the power on pads on the logic board to boot the system and use the mouse to sleep from the menu. Measure the voltage at the LED connector. If power is present, replace bottom case.
5. Replace logic board.

---

Apple Service Source



Views

---

MacBook Pro  
(17-inch & 17-inch Core 2 Duo)

# MacBook Pro (17-inch) Exploded View

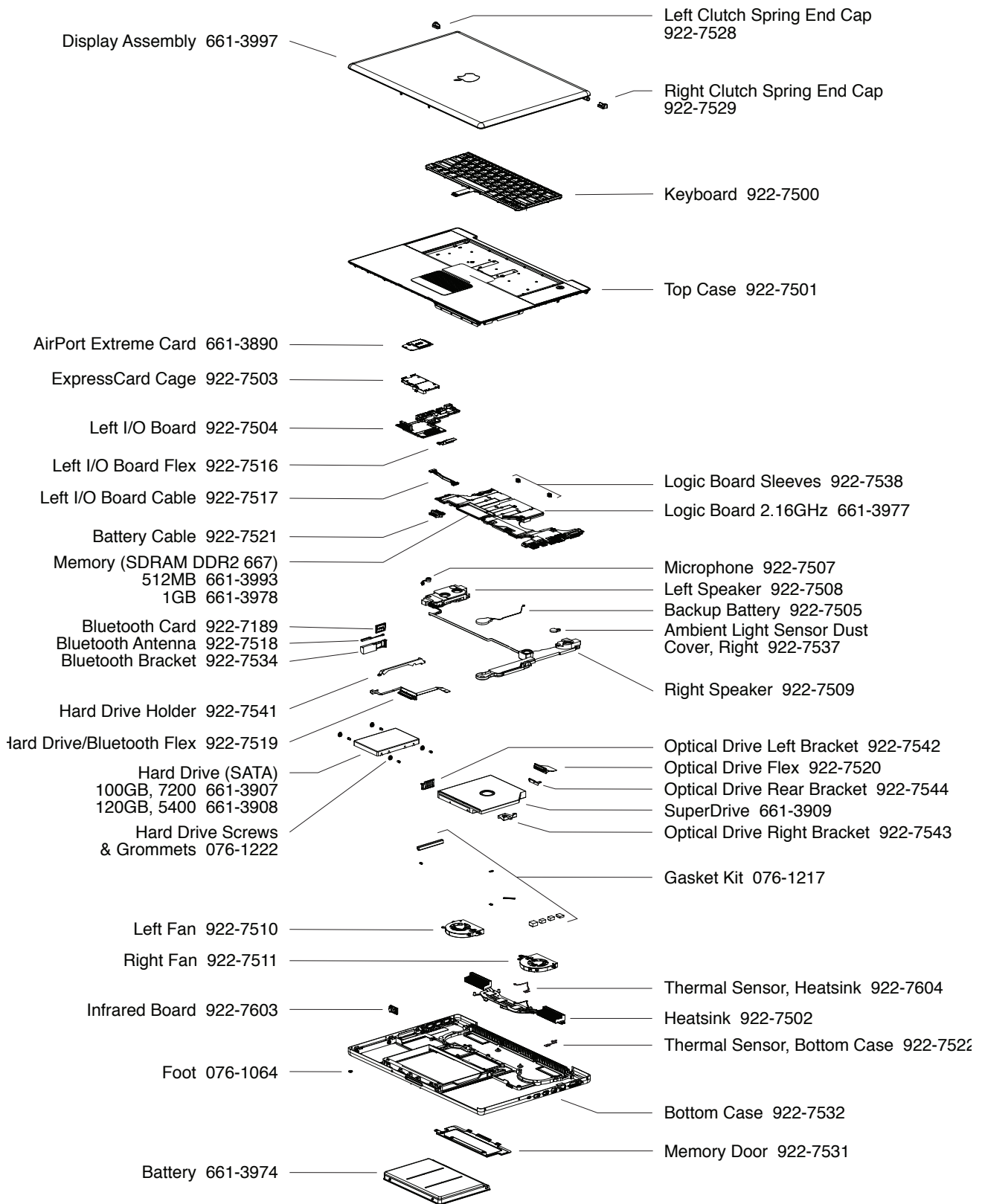

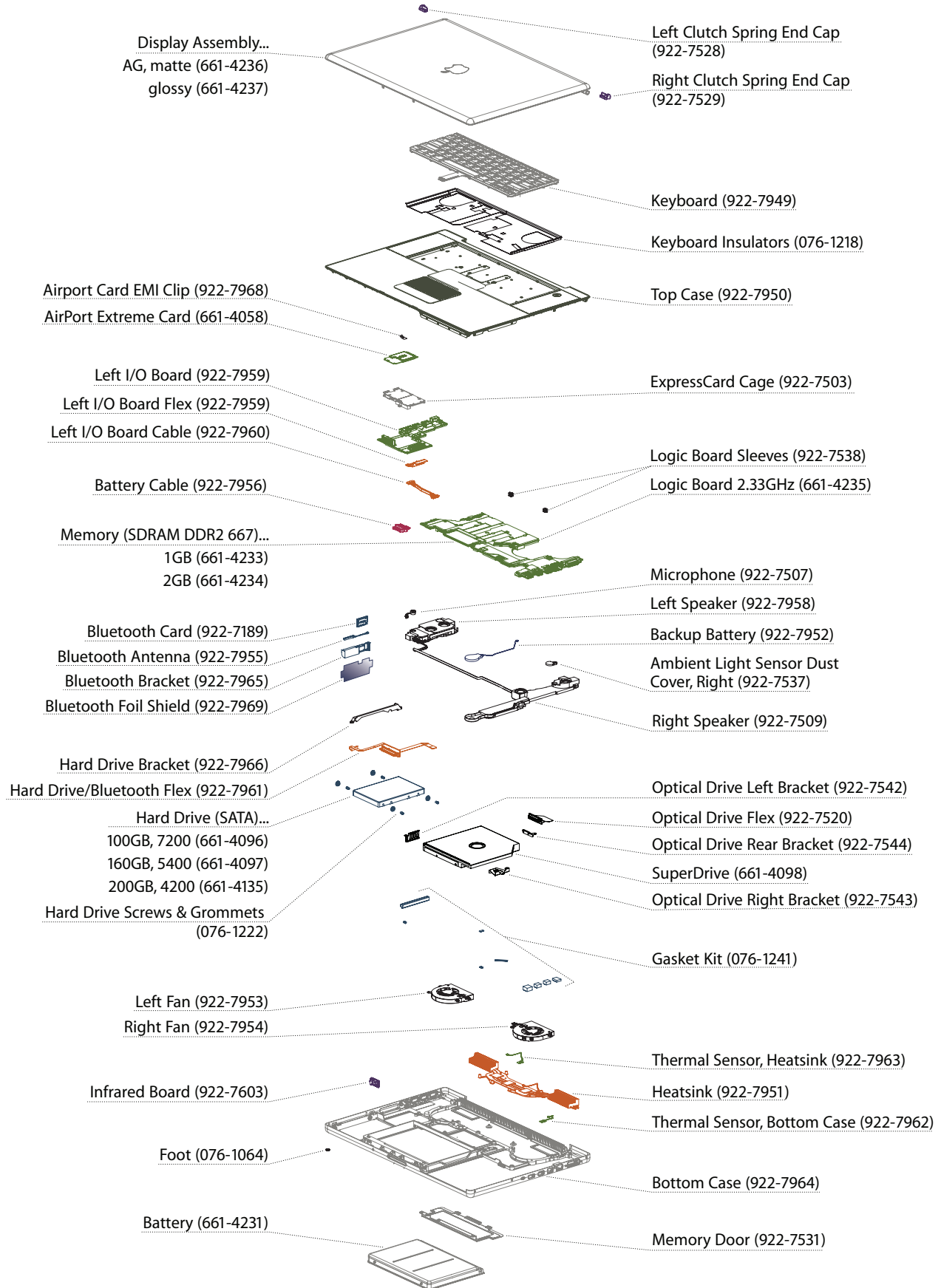

# MacBook Pro (17-inch Core 2 Duo) Exploded View



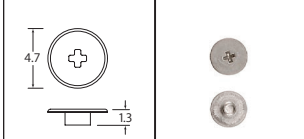
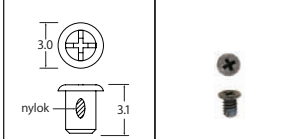
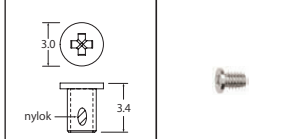
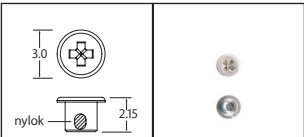
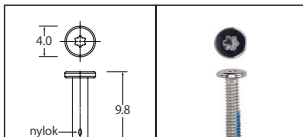
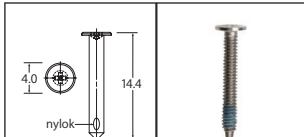
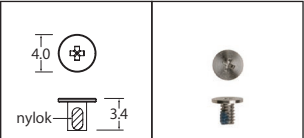
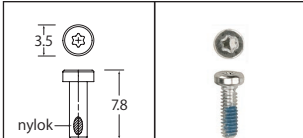
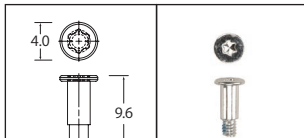
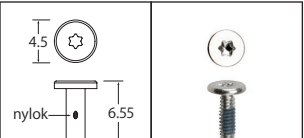

# Screw Chart

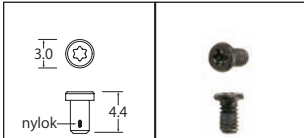
<p><b>922-5838</b>      <b>Phillips</b></p>  <p>M2 x 1.3L*      <b>actual size</b></p> <p>keyboard, ExpressCard cage</p>	<p><b>922-6090</b>      <b>Phillips</b></p>  <p>M2 x 2.8L*      <b>actual size</b></p> <p>ExpressCard cage</p>	<p><b>922-6091</b>      <b>Phillips</b></p>  <p>M2 x 2.8/3*, H3      <b>actual size</b></p> <p>bottom case (left, right, back)</p>
<p><b>922-6488</b>      <b>Phillips #0</b></p>  <p>M2 x 1.85*      <b>actual size</b></p> <p>optical drive brackets</p>	<p><b>922-7305</b>      <b>Torx T6</b></p>  <p>M2 x 9L*      <b>actual size</b></p> <p>under RAM door to keyboard, left and right clutches</p>	<p><b>922-7309</b>      <b>Phillips</b></p>  <p>M2 x 14*      <b>actual size</b></p> <p>bottom / top case</p>
<p><b>922-7524</b>      <b>Phillips</b></p>  <p>M2 x 3L*      <b>actual size</b></p> <p>battery well to top case, RAM door to top case</p>	<p><b>922-7525</b>      <b>Torx T6</b></p>  <p>M2 x 6.5L*, 3.5D      <b>actual size</b></p> <p>fans, left speaker, logic board, left and right clutches</p>	<p><b>922-7606</b>      <b>Torx T6</b></p>  <p>M2 x 7L*, shoulder      <b>actual size</b></p> <p>battery cable connector</p>
<p><b>922-7610</b>      <b>Torx T6</b></p>  <p>M2 x 5.75L*, 4.5D      <b>actual size</b></p> <p>logic board, hard drive bracket</p>	<p><b>922-7941</b>      <b>Torx T6</b></p>  <p>screw + grommet      <b>actual size</b></p> <p>hard drive screw + grommet</p>	<p><b>922-8015</b>      <b>Phillips</b></p>  <p>M2 x 3.5*, H3.0      <b>actual size</b></p> <p>Airport card, optical drive, ALS, infrared board, left I/O board</p>

\*This screw specification is thread and shank only. See CAD diagram above it for full screw length (including head).



# Architecture

The architecture of the MacBook Pro is based on the Intel Core 2 Duo microprocessor and two integrated circuits (ICs): the North Bridge memory controller and the South Bridge I/O controller, connected to each other by a Direct Media Interface (DMI) bus. The North Bridge IC provides the bridging functionality among the processor, the memory system, the DMI bus, and the 16-lane PCI Express bus to the graphics controller. The South Bridge IC supports these components:

- Ultra ATA/100 bus for the optical drive (running at UATA/66)
- A 1.5 Gbps Serial ATA (SATA) bus for the hard disk drive
- 1-lane PCI Express link for the AirPort Extreme module, 1 for Ethernet, and 1 for ExpressCard
- SPI bus, direct memory access bus to the boot ROM
- USB 2.0 controller, which in turn supports the Bluetooth module, IR receiver, built-in iSight camera, built-in trackpad and keyboard, ExpressCard 34 mm slot, and 2 USB 2.0 ports
- Channel to the audio subsystem
- 33MHz, 32-bit internal PCI bus to the FireWire 400 (1394a) and FireWire 800 (1394b)
- Direct Media Interface (DMI) bus

Figure 1 provides a simplified block diagram of the North Bridge and South Bridge ICs and the buses that connect them together.

