



MacBook (13-inch)

MacBook (13-inch) and
MacBook (13-inch Late 2006)

Updated 1 December 2006

MacBook (13-inch)

Contents

Take Apart

- What's New 7
- Vertical-Insert Connectors 10
- Tools 10
- Power Adapter 11
- Temperature Concerns 11
- Note About Images in This Manual 11
- Simplified Flowchart for Take Apart 12

Battery 13

RAM Door (L-Bracket) 16

Memory (DIMMs) 20

- Removal Procedure 21
- Replacement Procedure 22
- Removing a Stuck Memory Card 24

Hard Drive 25

Top Case (with Keyboard) 28

Trackpad Cable (Late 2006 Model Only) 40
Procedure 41

AirPort Extreme Card 45

MagSafe DC-In Board 50

Left Speaker 54

Battery Connector with Sleep Switch 58

Hard Drive Connector 64

Fan 70

Heatsink 73

- Checking the Thermal Grease 77
- Comparing Heatsinks 83

Bluetooth Holder	84
Optical Drive	88
Optical Drive Cable	98
I/O Frame (with upper EMI shield)	102
Logic Board	106
DIMM Lever Kit	115
Backup Battery	119
Bluetooth Antenna Board and Cable	122
Bluetooth Board	126
Bluetooth-to-Logic Board Cable	130
Subwoofer with Right Speaker Cable	135
Midframe	141
Display Bezel	146
Removal Procedure	147
Replacement Procedure	150
Spacers at Bezel Scoops	153
C-Channel	155
Clutch Block, Left	159
Clutch Block, Right	166
Clutch Caps	170
(Refer to "Clutch Block, Left" and "Clutch Block, Right")	170
Display Module	171
Bottom Case	178
Clutch Cover	182
Bezel Scoops, Left and Right	188
LCD Panel	192
Antenna Receptors and Cables, Top and Left	197
Antenna Receptor and Cable, Right (Late 2006 Model Only)	202

LCD Panel Assembly	209
Removal Procedure	211
Reinstallation Procedure	216
Foil at Camera Bracket	223
Spacers at Camera Bracket	226
Camera Assembly	228
LVDS Cable with USB Line	234
Microphone Cable	241
Inverter Board	248
Inverter Cable	251
Display Hinges, Left and Right	254
Bezel Brace, Left	257
Bezel Brace, Right	259
Sleep Magnet	263
Display Magnet Pairs	266
Display Rear Housing	270

Additional Procedures

General Information	274
Replacing Darfon Keycaps	275
Preliminary Steps	275
Part Location	275
Procedure	275
Replacing Mitsumi Keycaps	290
Preliminary Steps	290
Part Location	290
Procedure	291

Troubleshooting

General Information	306
Troubleshooting Steps	307

Symptom Charts 310

Block Diagram 320

Views

External and Internal Views 323

Front: Keyboard and IR Window 323

Back: Air Vents and Display Clutch 324

Left Side: Ports 324

Right Side: Slot Drive 324

Battery Bay: Memory Card Levers and Hard Drive Pull Tab 325

Top Case Removed: Main Modules and Cable Routing 325

Screw Matrix 331

Top Case Screw Locations 331

Display Module Screw Locations 332

Logic Board Screw Locations 333

Screw Reference Chart, Part 1 of 2 334

Screw Reference Chart, Part 2 of 2 335

Exploded Views 336

MacBook (13-inch)—Display Exploded View 336

MacBook (13-inch)—Main Exploded View 337

MacBook (13-inch Late 2006)—Display Exploded View 338

MacBook (13-inch Late 2006)—Main Exploded View 339

Service Source



Take Apart
MacBook (13-inch)



What's New

The MacBook (13-inch) portable computer is the first computer of its size featuring the Intel Core Duo processor and built-in iSight video camera. The main features and service differences (from similar-sized Apple portable computers) include:

- Higher resolution 13.3-inch LCD panel
- iSight camera built-in
- Infrared sensor on front right corner
- Hard drive is offered as a customer-replaceable module
- Digital audio-in
- MagSafe magnetic power connector
- Supports extended desktop
- Vertical-insert connectors—most of the cable connectors on the logic board use a new design that requires special insertion and extraction (refer to the section “Vertical-Insert Connectors” in this chapter)
- Feet on the bottom case are heat-staked, so they are not removable
- Built-in keyboard as part of top case
- Operating temperature is hotter than previous models (refer to “Temperature Concerns” in this chapter)

The following table shows the MacBook (13-inch) model configurations at introduction:

Feature	Good	Better	Best
Intel Core Duo processor	1.83 GHz	2.0 GHz	2.0 GHz
Memory	512 MB (x2)	512 MB (x2)	512 MB (x2)
Hard Drive	60 GB	60 GB	80 GB (120 GB)
Optical Drive	Combo, 9.5 mm	Super, 9.5 mm	Super, 9.5 mm
Housing	White	White	Black
Display	13.3-inch, 1280x800, 114 dpi, Low Reflection Glossy Polarizer (LRGP)		
Battery	55-Whr Lithium Polymer		
Power Adapter	60 W, A70, MagSafe MPM		

The following table shows the MacBook (13-inch Late 2006) model configurations at introduction:

Feature	Good	Better	Best
Intel Core 2 Duo processor	1.83 GHz	2.0 GHz	2.0 GHz
Memory	512 MB (x2)	1 GB (x2)	1 GB (x2)
Hard Drive	60 GB	80 GB	120 GB, (160 GB, 200 GB)
Optical Drive	Combo, 9.5 mm	Super, 9.5 mm	Super, 9.5 mm
Housing	White	White	Black
Display	13.3-inch, 1280x800, 114 dpi, Low Reflection Glossy Polarizer (LRGP)		
Battery	55-Whr Lithium Polymer		
Power Adapter	60 W, A77, MagSafe MPM		

Keyboard integral to top case:



Product name on display bezel:



MagSafe power connector port:

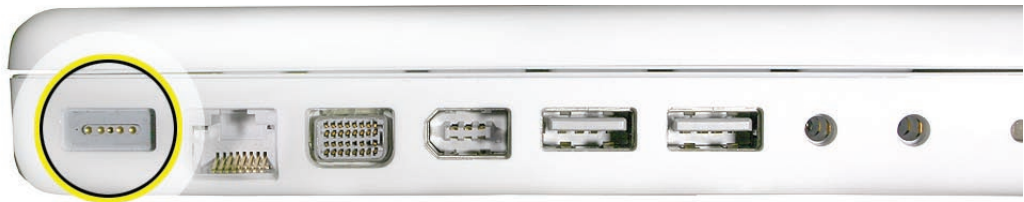

Infrared window on front of computer:



For additional views of the computer, refer to the "Views" chapter at the end of this manual.

Vertical-Insert Connectors

Most of the cable connectors on the logic board use a new design that requires special insertion and extraction. Caution: To prevent damage to the connectors, install them from the front (away from the cable) when reconnecting vertical-insert cables to the logic board.

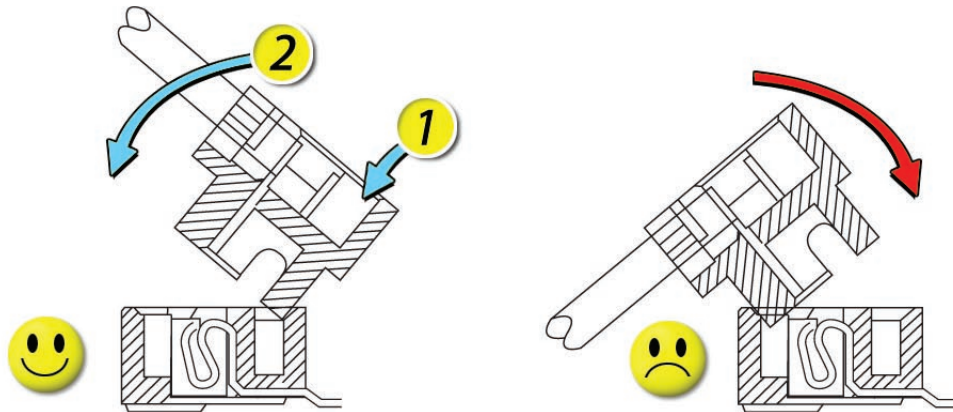

Tools

Caution: To prevent scratches or other cosmetic damage to the computer housing, use a soft cloth as a protective layer when removing and installing the external screws.

The tools required to service this computer include:

- Clean, soft, lint-free cloth
- Coin
- ESD wrist strap and mat
- Magnetic Phillips #0 screwdriver
- Magnetic Phillips #00 screwdriver (preferably with a long handle)
- Black stick (Apple probe tool, part number 922-5065) or other nonconductive nylon or plastic flatblade tool
- Access card (Apple part number 922-7172) to open the top case
- Jeweler's flatblade screwdriver
- Needlenose pliers
- Stack of books, weighted boxes, or other means of support for display while removing screws from hinge
- Thermal grease (Apple thermal compound syringe, part number 922-7144)
- Alcohol wipes
- Permanent marking, felt-tip pen
- Standard size CD or DVD disc

Power Adapter

Warning: The power adapter for this computer is unique to this model. It uses an MPM 4-pin adapter plug. Do not use this power adapter with any other portable computer. Power adapters from earlier iBook or PowerBook computers are not compatible and will not fit the MPM plug.

Temperature Concerns

This computer runs hotter than previous models. However, the normal operating temperature is well within national and international safety standards. Nevertheless, customers may be concerned about the generated heat. To prevent an unneeded repair, you can compare a customer's computer to a running model, if available, at your repair site. For more information on temperature concerns and customer perception, refer to Knowledge Base article 30612 "Apple Notebooks: Operating Temperature."

<http://docs.info.apple.com/article.html?artnum=30612>

Note About Images in This Manual

Because a pre-production model was used for most of the images shown in this manual, you may notice small differences in appearance between the image pictured and the computer you are servicing. However, although the appearance differs, the steps and sequence are the same unless noted.

Memory Card Levers

Important: The following image shows the memory cards and hard drive installed in the battery bay. Note the correct position of the memory card levers. Some images pictured in this manual used a pre-production model, so the direction and appearance of the levers differ from the accurate depiction below. Refer to the Views chapter for other useful reference images.



Simplified Flowchart for Take Apart

Although this flowchart does not include every serviceable part, you can use it as a reference after becoming familiar with the detailed removal procedures.

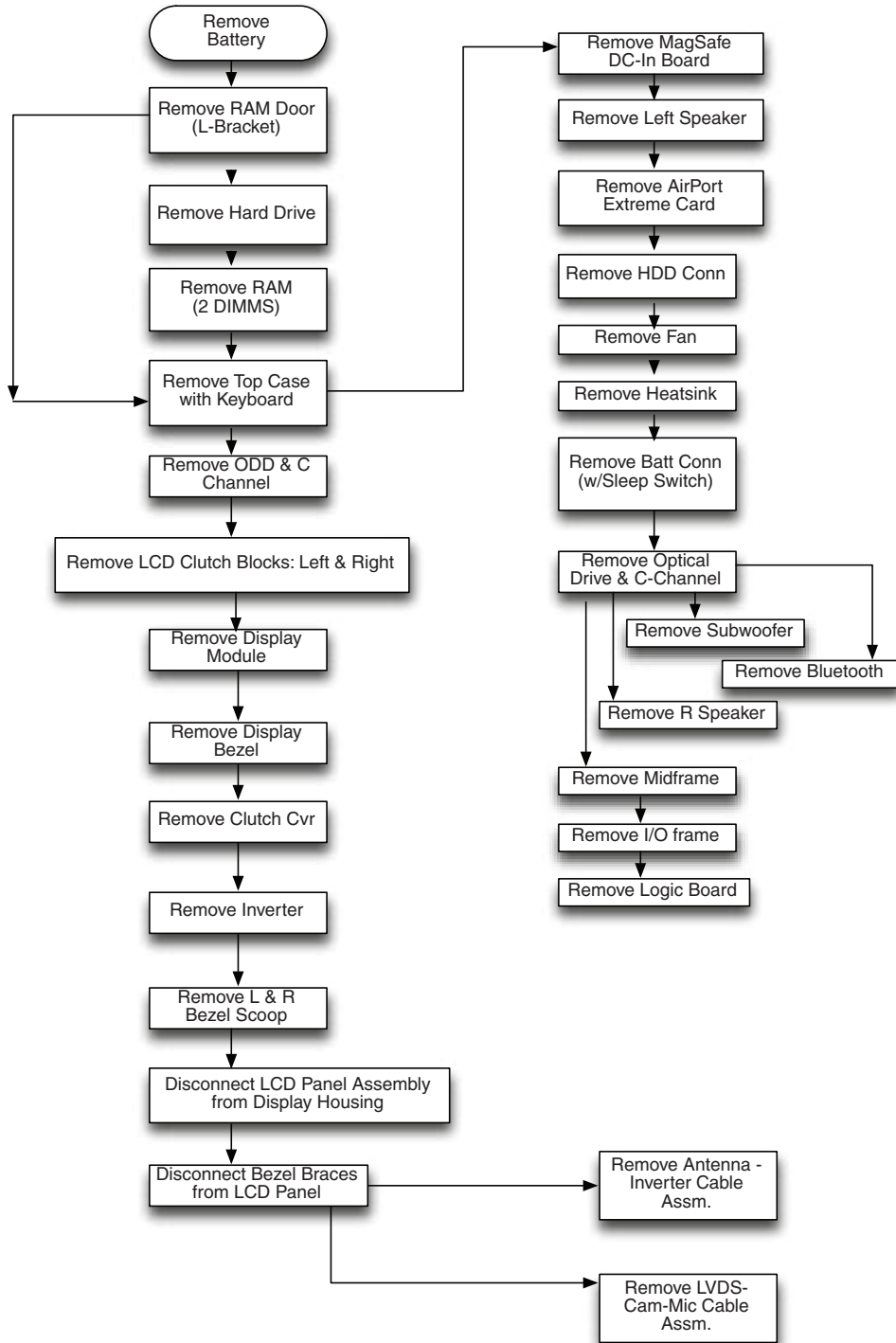



Battery

Tools

- Clean, soft, lint-free cloth
- Coin

Part Location



Preliminary Steps

Warning: Always shut down the computer before opening it to avoid damaging the internal components or causing injury. After you shut down the computer, the internal components can be very hot. Let the computer cool down for 30 minutes before continuing

Procedure

1. Shut down the computer.
2. Wait 30 minutes to allow the computer's internal components to cool.
3. Unplug all external cables from the computer except the power cord.
4. Unplug the power cord.
5. Put on an ESD wrist strap.
6. Turn over the computer and place it on a soft cloth.



7. Use a coin to release the battery latch. Turn the coin a quarter turn clockwise to unlock the battery.
Caution: To prevent scratches or other cosmetic damage to the bottom case, use only a coin to unlock and lock the battery.
8. Lift out the battery from the battery bay.



-
9. To install the replacement battery, tilt the foot end of the battery into the battery bay first. Then press and hold down the other end of the battery as you turn the coin to lock it into place.



10. Reassemble and test the computer.



RAM Door (L-Bracket)

Tools

- Soft cloth
- ESD wrist strap and mat
- Magnetic Phillips #0 screwdriver
- Black stick (Apple part number 922-5065) or other nonconductive nylon or plastic flatblade tool

Part Location

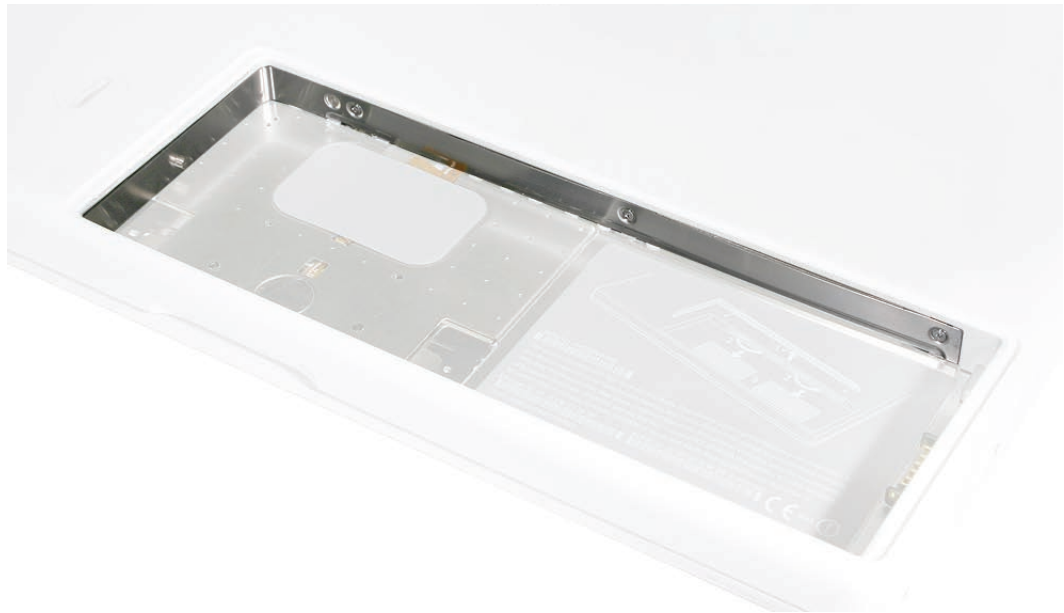

Preliminary Steps

Before you begin, remove the battery.

Procedure

1. With the computer closed and upside down on a soft cloth, touch a metal surface inside the battery bay to discharge any static electricity.



2. Loosen—but do not try to remove—the three captive screws along the RAM door.

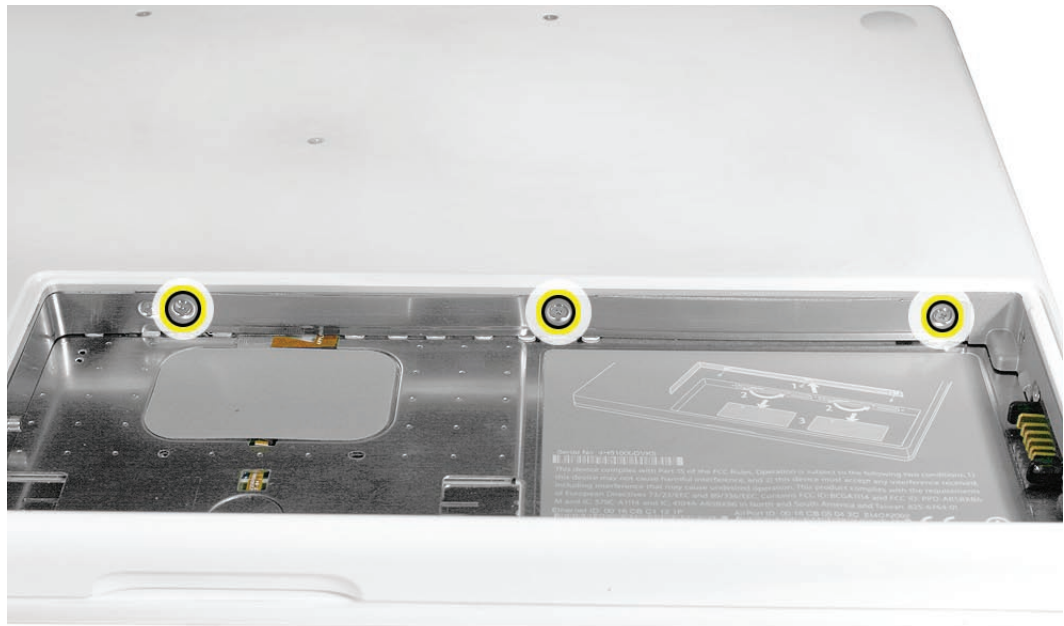

-
3. Holding the long end of the L-shaped RAM door, pivot it out from the battery bay. (If necessary, use a black stick to tilt it up and out of the battery bay.) Be careful not to bend it.



Replacement Note: Before replacing the RAM door, make sure that

- Hard drive pull tab is not exposed
- Cards are fully inserted
- Memory card levers are fully down before replacing the RAM door

Replacement Note: Check that the replacement RAM door has a rubber cushion to protect the hard drive opening and two EMI gaskets to protect the memory card openings.



-
- 4. Replacement Note:** Install the replacement RAM door by first aligning the short end at the notch near the hard drive opening.



Replacement Note: Use a black stick, if necessary, to tuck in the EMI gaskets so they do not protrude from the edge of the battery bay. Make sure the three screws align with the holes in the bottom case before tightening them.

- 5.** Reassemble and test the computer.





Memory (DIMMs)

This computer comes with a minimum of 512 MB of 667 MHz Double Data Rate 2 (DDR2) Synchronous Dynamic Random-Access Memory (SDRAM) installed. It has two slots that can accept SDRAM Small Outline Dual Inline Memory Modules (SO-DIMMs). The slots are side-by-side on the logic board behind the RAM door. For best performance, memory should be installed as pairs with an equal memory card in each slot. The maximum amount of memory for this computer is 2 GB, with 1GB DIMM installed in each slot.

Memory cards must meet these requirements:

- 1.25 inch or smaller
- 256 MB, 512 MB, or 1 GB
- 200-pin
- PC-5300 DDR2 667 MHz Type RAM

Tools

- ESD wrist strap and mat

Preliminary Steps

Before you begin, remove

- Battery
- RAM door

Part Location

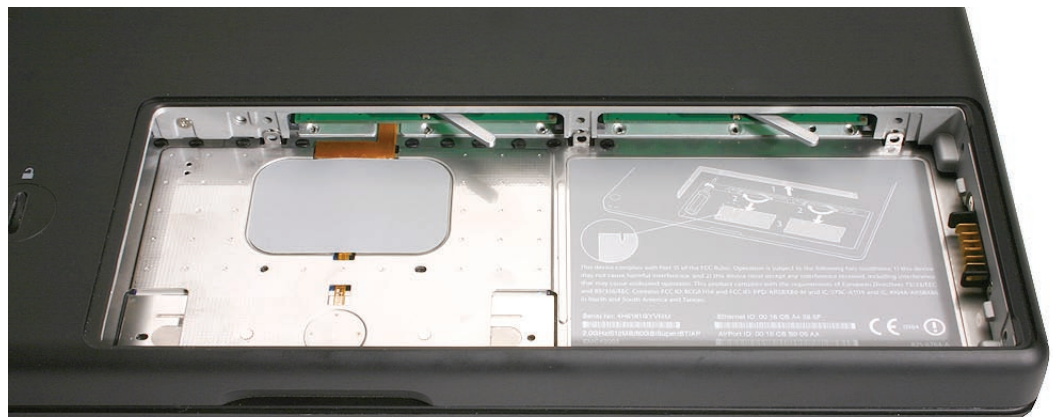

Removal Procedure

1. Touch a metal surface inside the battery bay to discharge any static electricity.
2. Put on an ESD wrist strap.
3. In one swift motion, use one finger to move the lever to the left and release it. This swift motion ejects the memory card.

Caution: The memory card eject levers are on a spring hinge that operates on a side-to-side horizontal plane. The mechanism can be damaged if the lever is forced outside of that horizontal movement. To prevent damage to a lever, move it swiftly—in one sideways direction only.

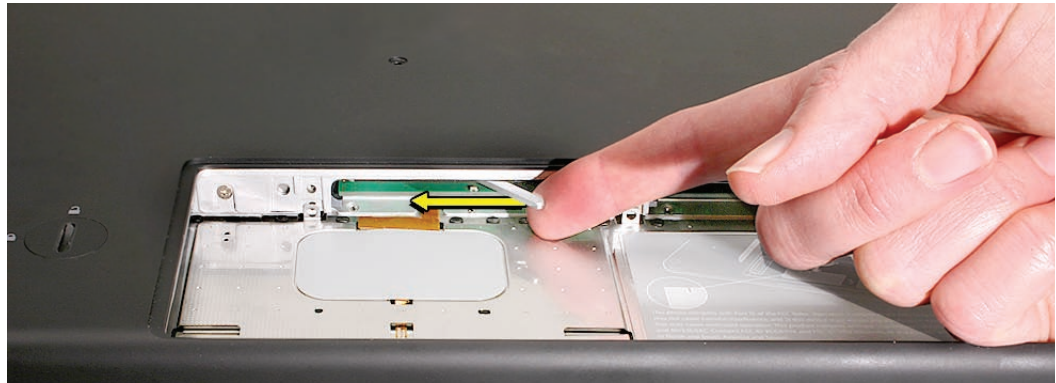

Note: Refer to the following if an issue occurs with a lever:

- If the lever wobbles, the lever may not be fully screwed in. Refer to “DIMM Lever Kit” in this chapter.
- If the lever offers no resistance, the spring mechanism may be damaged. Refer to “DIMM Lever Kit” in this chapter.
- If the lever is stuck in a completely closed position (recessed underneath the bottom case), use a wooden pencil to gently pry it out, as shown below.

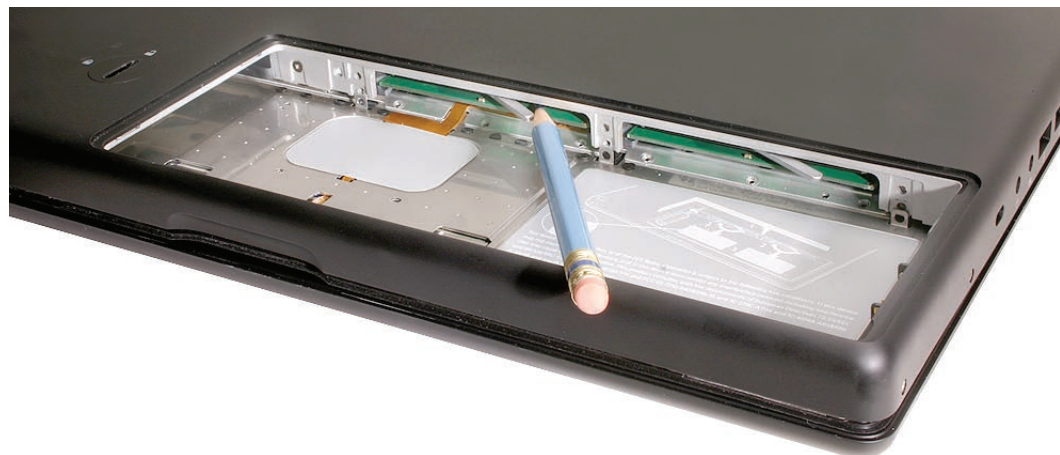

4. Holding the memory cards by the corners, slide them out from the battery bay.

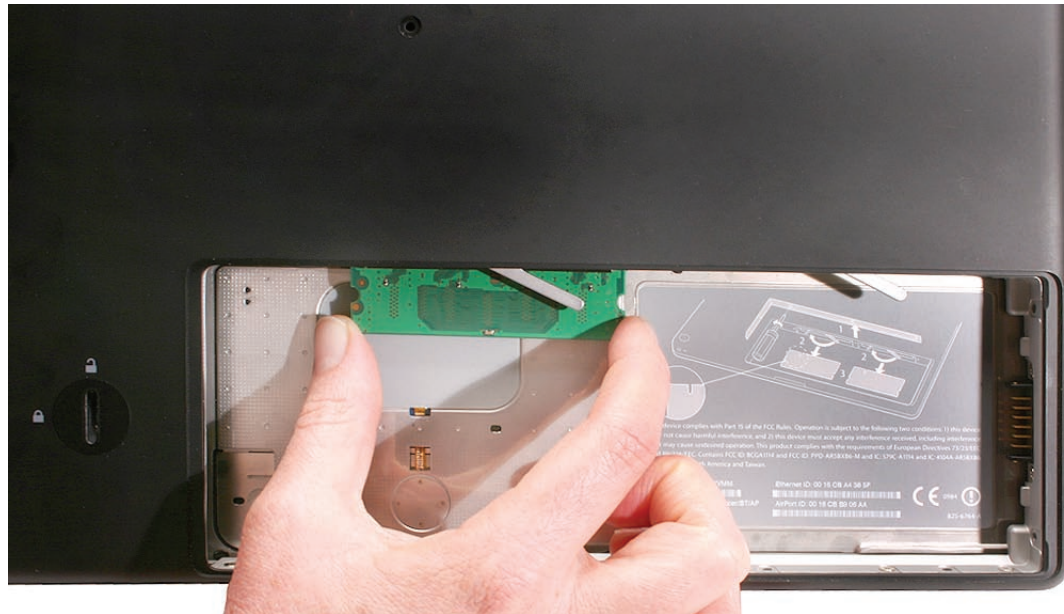

Important: Do not touch the gold connectors. Handle the card only by its edges.

Replacement Procedure

1. Align the memory card so that the gold connectors face the slot and the notch is on the left. (The chip side of the board faces down.)

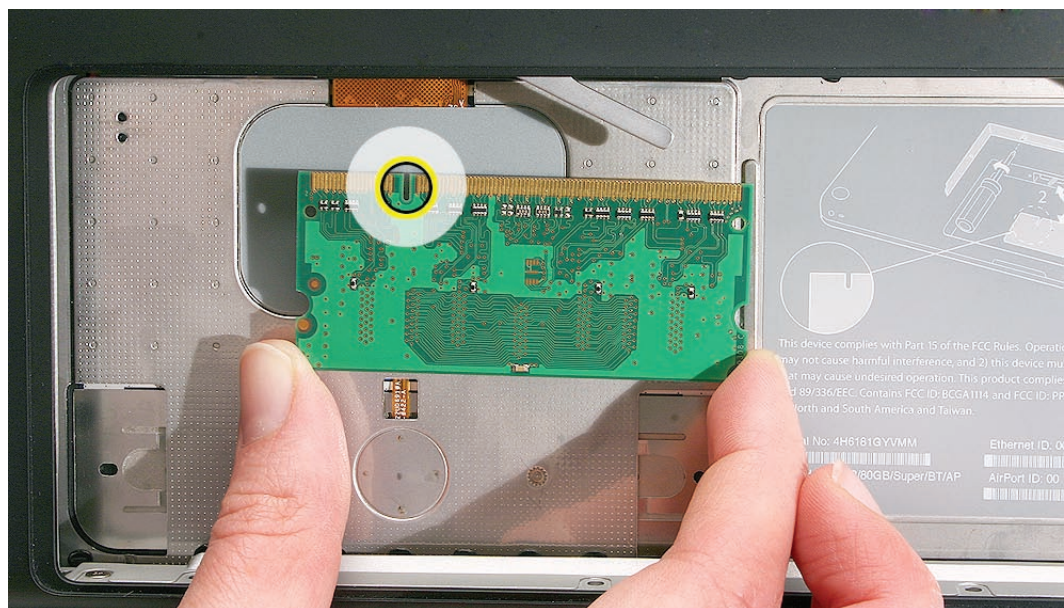

2. Use two fingers to push firmly on the edge of the memory cards. If there is a tight fit, installing the cards may take some force to ensure that they are fully inserted.



Important: When the cards are fully inserted, the edges of the cards are nearly hidden, as shown by the recessed card on the right in the image below.



3. If the levers do not return to the closed position, move them to close them.
4. Reassemble and test the computer.
5. Make sure the computer recognizes the new memory by opening System Profiler, clicking More Info, and clicking Memory.

Removing a Stuck Memory Card

If a lever becomes inoperable and does not eject a memory card, you must remove the top case to access the stuck memory card. Follow this procedure only if the memory card is stuck and cannot be ejected by using the lever.

1. Follow the “Top Case” procedure in this chapter to remove the top case.
2. Notice the eject bars on each side of the memory card carrier. Use a black stick to push and slide the eject bar down the side of the carrier.

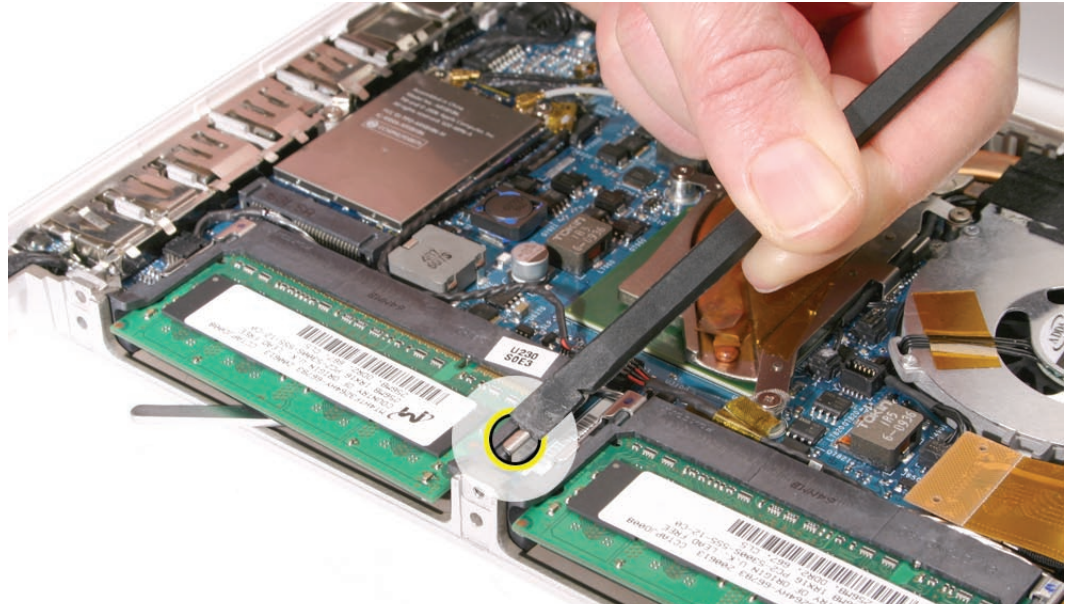

3. Repeat step 2 on the other side of the memory card carrier until the memory card pops out.

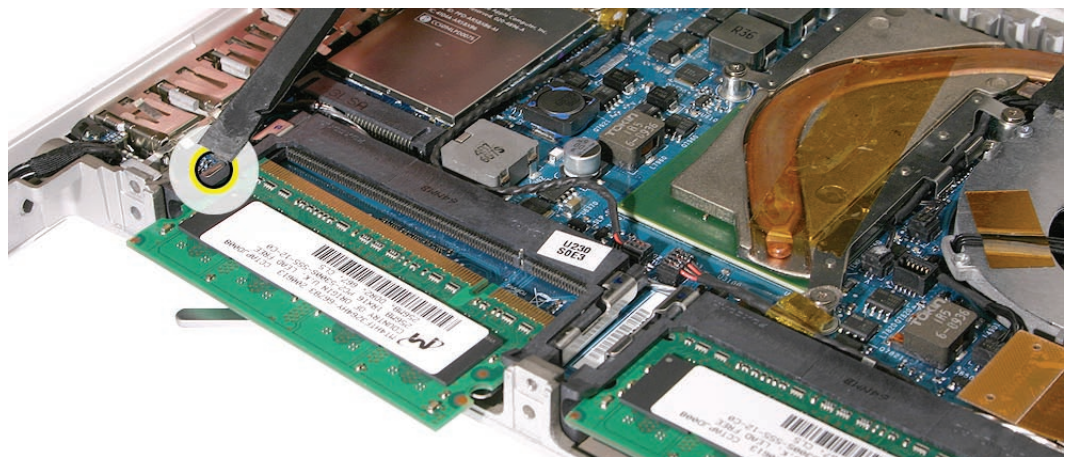



Hard Drive

Tools

- ESD wrist strap and mat
- Black stick (Apple part number 922-5065) or other nonconductive nylon or plastic flatblade tool

Preliminary Steps

Before you begin, remove

- [Battery](#)
- [RAM door](#)

Part Location

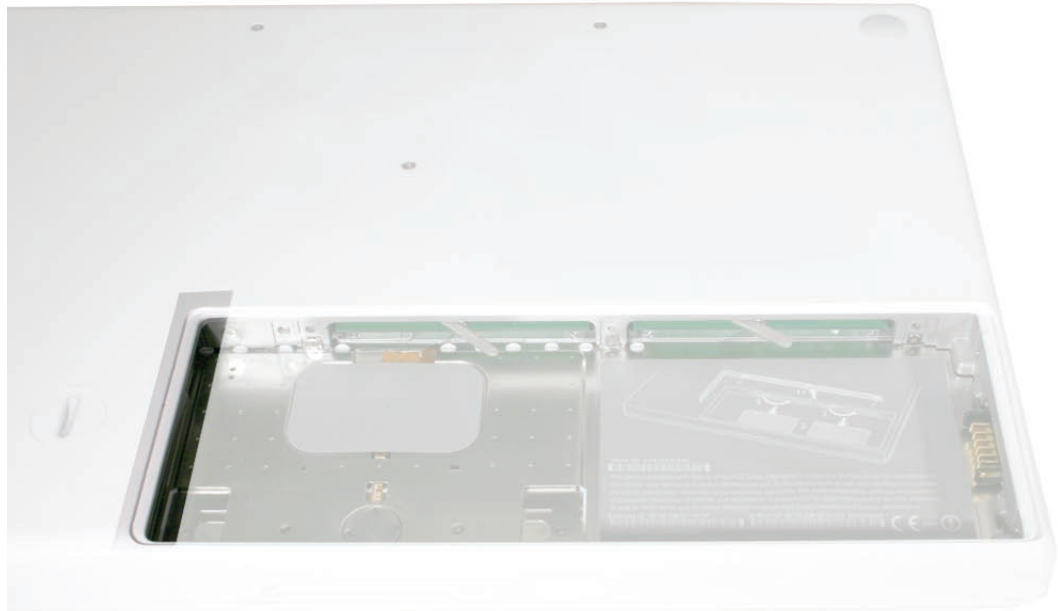

Procedure

1. If the hard drive pull-tab is tucked in, use a black stick to unroll it.

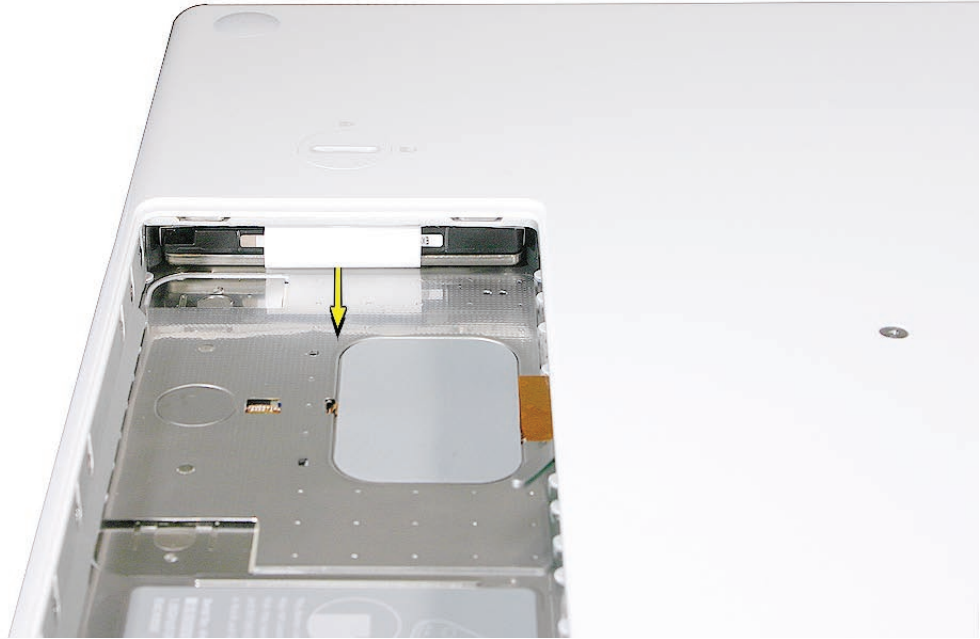

2. Pull the tab straight out to slide the drive out from the rubber rails in the battery bay.

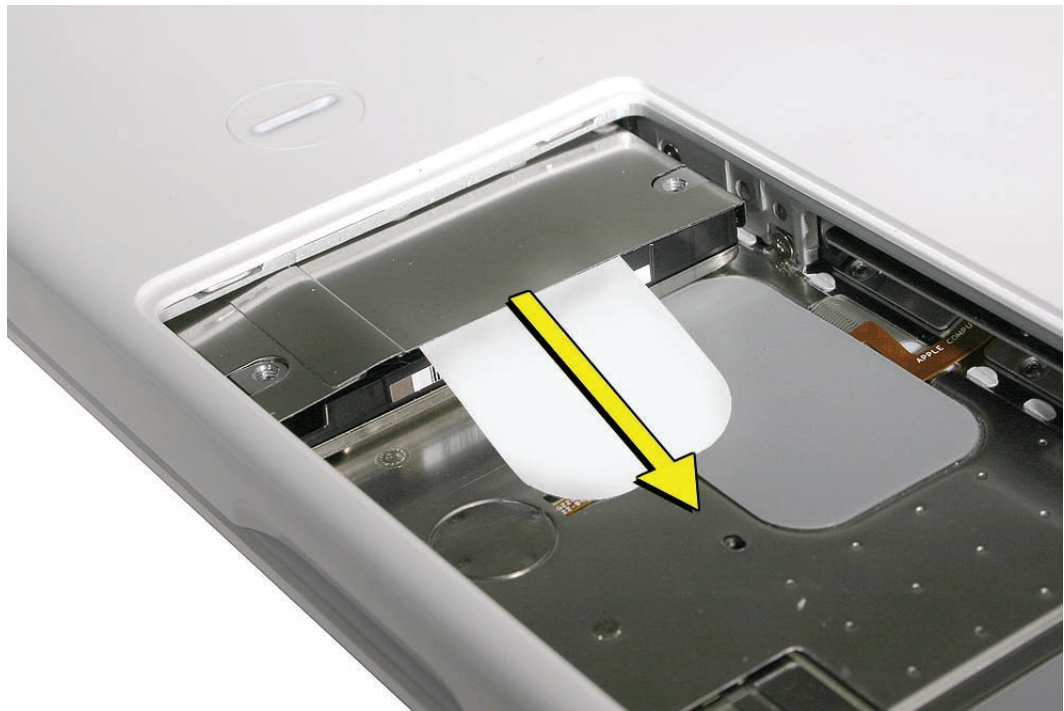

3. Hold the drive only by the sides when removing and replacing it.



4. Install the replacement hard drive, and reassemble and test the computer.

Important: After a new hard drive replacement, you must update the operating system to Mac OS X version 10.4.6 or later.

Replacement Note: If you are installing the hard drive while the top case is off, make sure the two bottom case spring guides are aligned with the notches in the bottom case. The image below shows the top spring centered and the bottom spring off center.

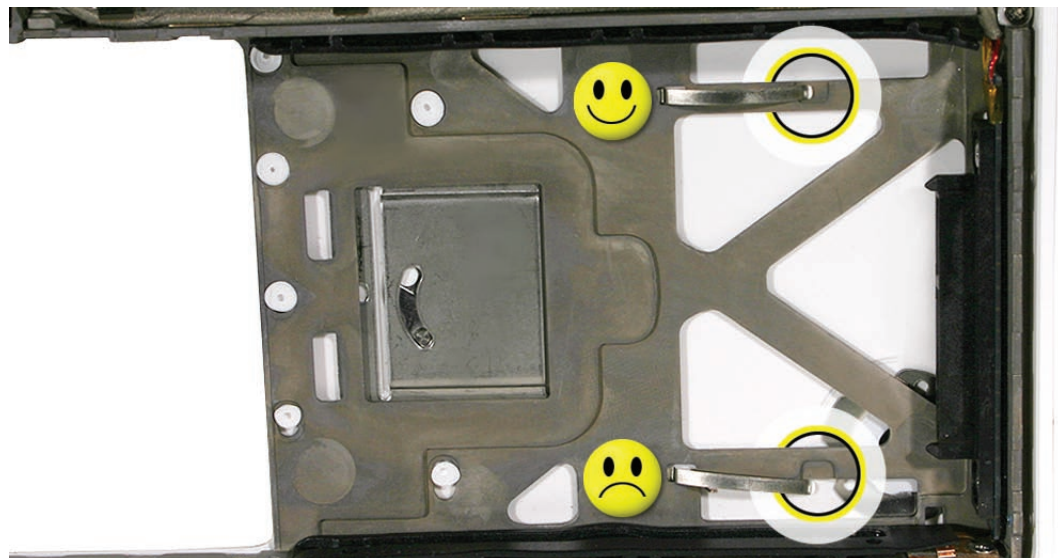



Top Case (with Keyboard)

Tools

- ESD wrist strap and mat
- Magnetic Phillips #0 screwdriver
- Magnetic Phillips #00 screwdriver (preferably with a long handle)
- Black stick (Apple part number 922-5065) or other nonconductive nylon or plastic flatblade tool
- Access card (Apple part number 922-7172) to open the top case
- Clean, soft, lint-free cloth

Preliminary Steps

Before you begin, remove

- [Battery](#)
- [RAM door](#)

Part Location



Procedure

Caution: To prevent scratches or other cosmetic damage to the computer housing, use a soft cloth as a protective layer when removing and installing the external screws.

1. With the computer upright, remove the two identical 5.5-mm long shoulder screws from the right side of the computer.

Replacement Caution: When installing these top case screws, do not press on the area over the slot drive. The slot-drive bezel could be damaged with too much pressure.



2. **Important:** Notice the two screws at the left side of the computer. Although they can be removed, they exist for cosmetic purposes only and do not require removal. If they are removed, however, be sure to reinstall the two identical 3-mm long shoulder screws at the corner near the ports. Do not use longer screws.



3. At the back of the computer, remove the four #0 Phillips screws (two at each side) near the display hinge--
 - Two 12-mm long shoulder screws that are closest to the hinge
 - Two 8-mm long shoulder screws at the back corners of the computer



-
4. Turn over the computer, and on the outside of the bottom case, remove the three #0 Phillips screws:
 - Two 14-mm long screws near display hinge
 - One 11-mm long at center of bottom case

Replacement Caution: Do not put one of the longer screws in the center screw hole or it will damage the logic board.

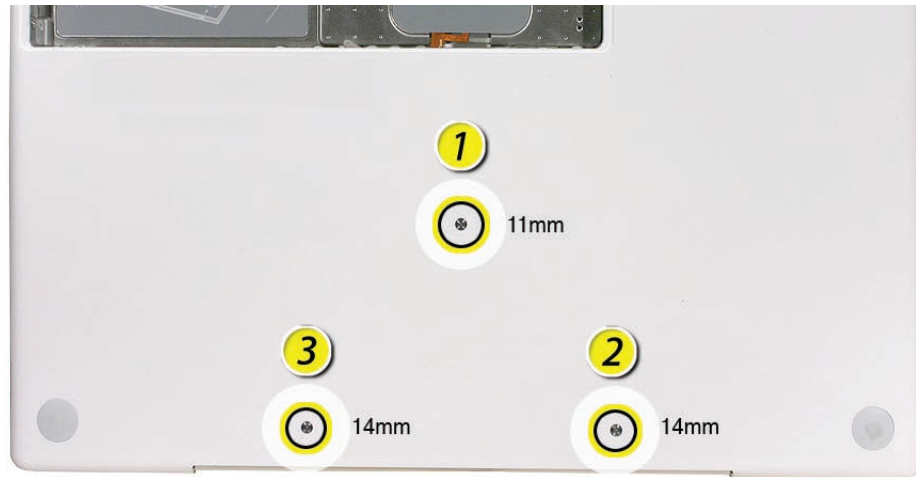

Replacement Caution: When installing the three bottom case screws, install them in the order shown.

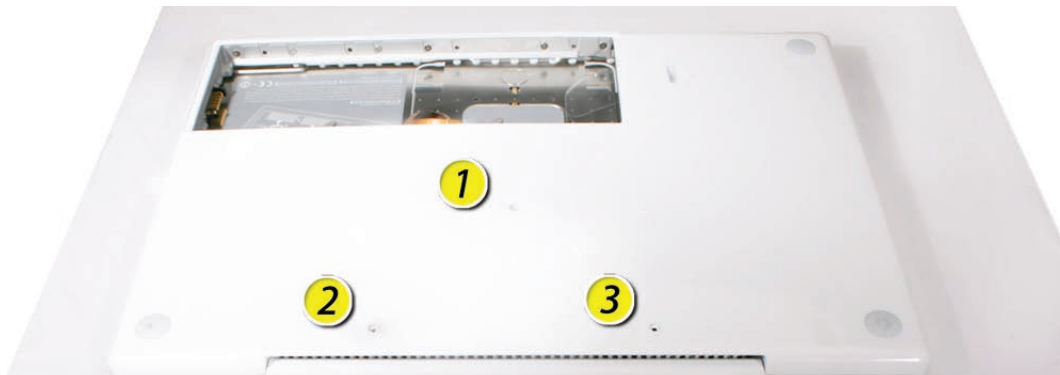

5. Notice the long row of #0 Phillips screws at the front edge of the battery bay.
6. **Important:** Remove only the four screws shown. Remove the 3-mm long identical screws as follows:

Starting at the corner closest to the battery connector, skip the first screw, then remove the second, fourth, seventh, and ninth screw.

Tip: To help remember the screw sequence, think of it as “2, 4, 7, 9 loosens the top case every time.”

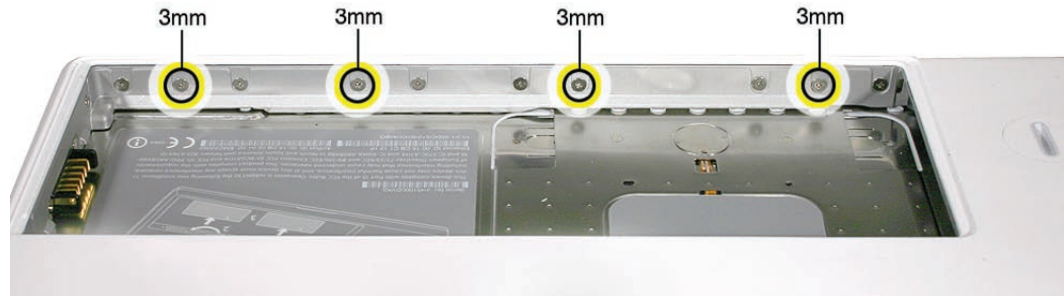

7. In the battery bay, remove the two 6-mm long identical screws that are on both outer sides of the battery connector. Do not remove the two screws that are closest to the battery connector.

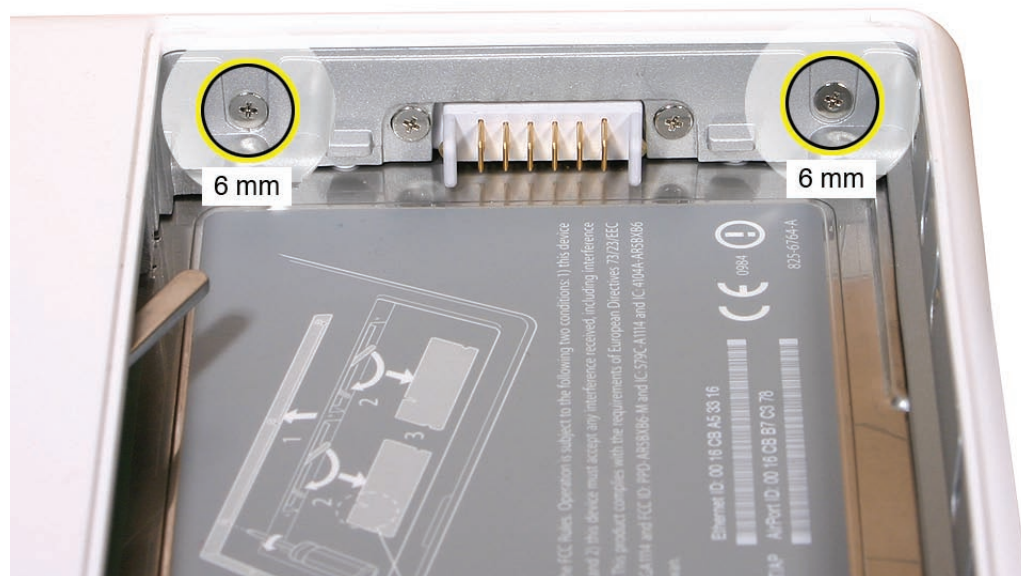

8. In the battery bay, use a long-handled screwdriver to remove the three #00 Phillips screws at the inner edge of the battery bay near where the RAM slots are located:
 - Two identical 3-mm long screws
 - One longer 4.5-mm long screw at the corner of the battery bay nearest the battery connector

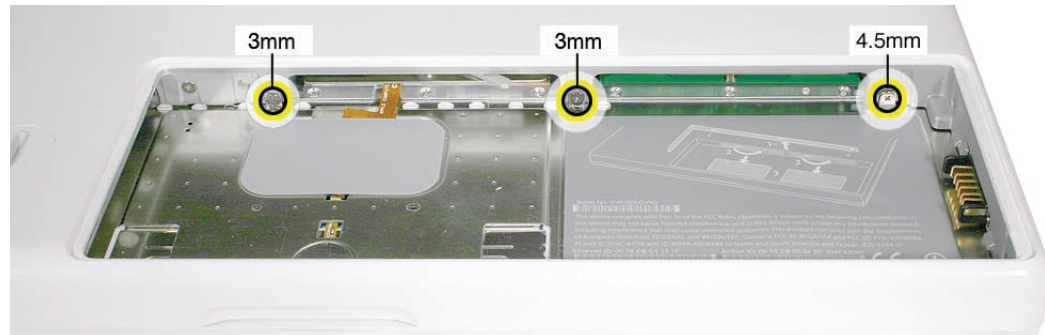

Because this is a recessed area, the screwdriver has to go in at an angle. Keep the screwdriver in line with the screw head as much as possible.

Replacement Caution: When installing these three screws, an incorrect installation could cause the reassembled computer to wobble in use. To prevent a wobble symptom, use light pressure to hold the top case onto the assembly when installing the screws.

9. Open the display to a 90-degree angle or wider.
10. **Warning:** Inserting a tool too far or performing this step too quickly could break some of the snaps that secure the top case. Be especially careful with the left front corner of the top case. Starting at the left corner and working in a counter-clockwise direction, use an access card tool to open the gap along the front of the top case, around the perimeter, and to the right side above the optical drive slot.



-
11. With the top and right side gap opened, tilt up—but do not remove—the right edge of the top case. This motion releases the remaining snaps between the top case and bottom case, and the slot-load bezel clips become loose as the top case is tilted up.



-
12. Raise up the top case so you can see where the folded trackpad flex cable attaches to the logic board.

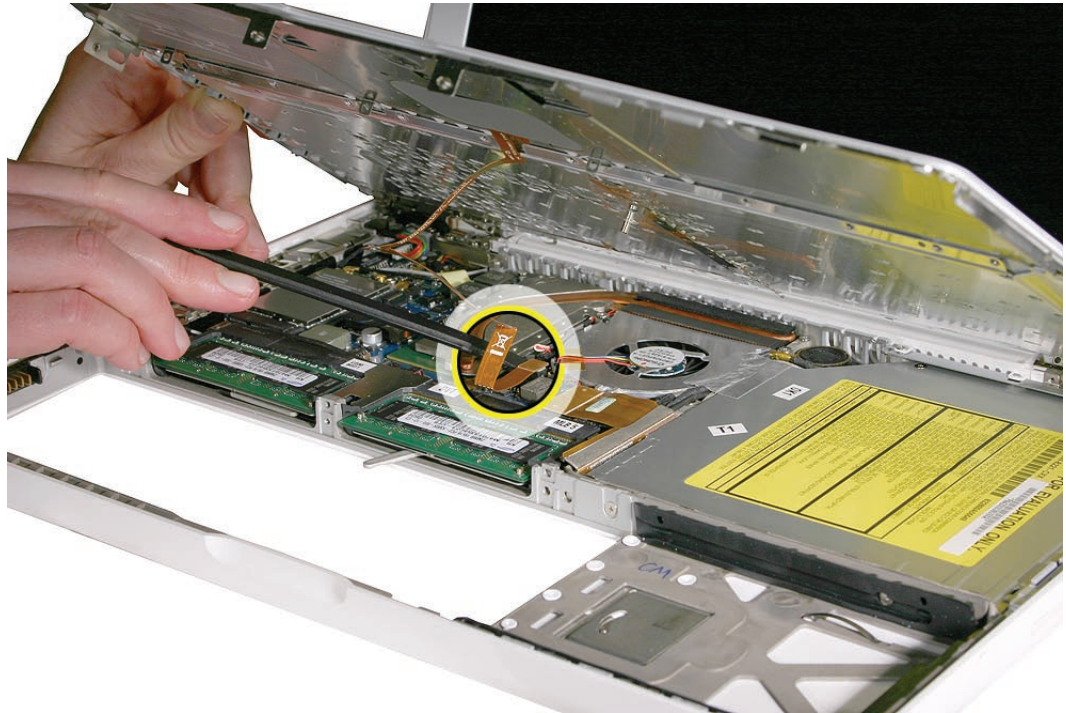

Late 2006 Model:

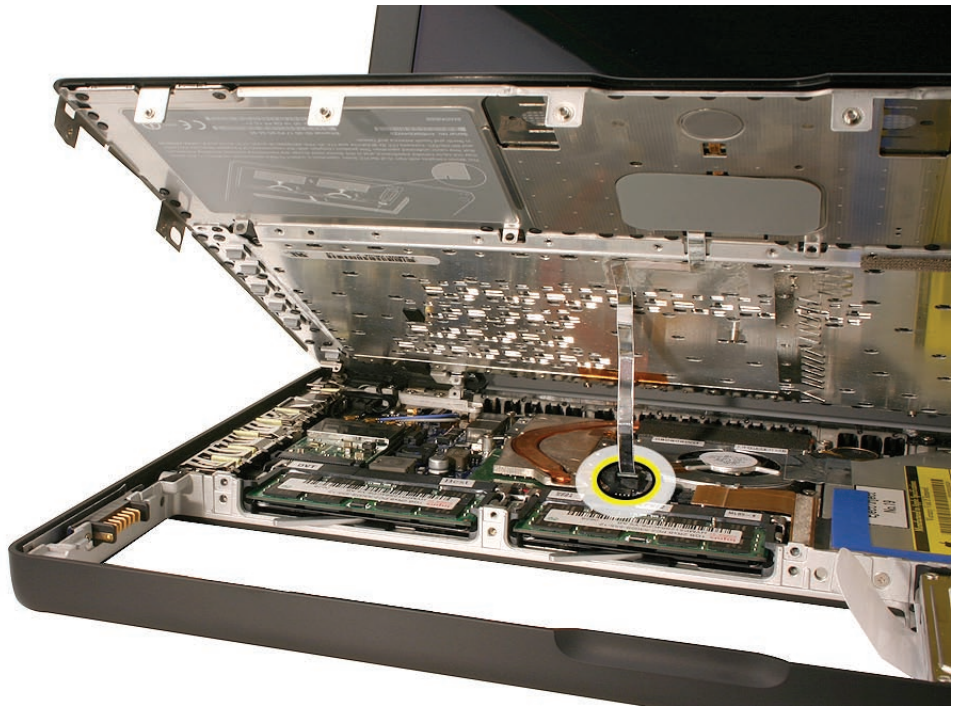

13. Use the flat end of a black stick to reach in and disconnect the trackpad cable.

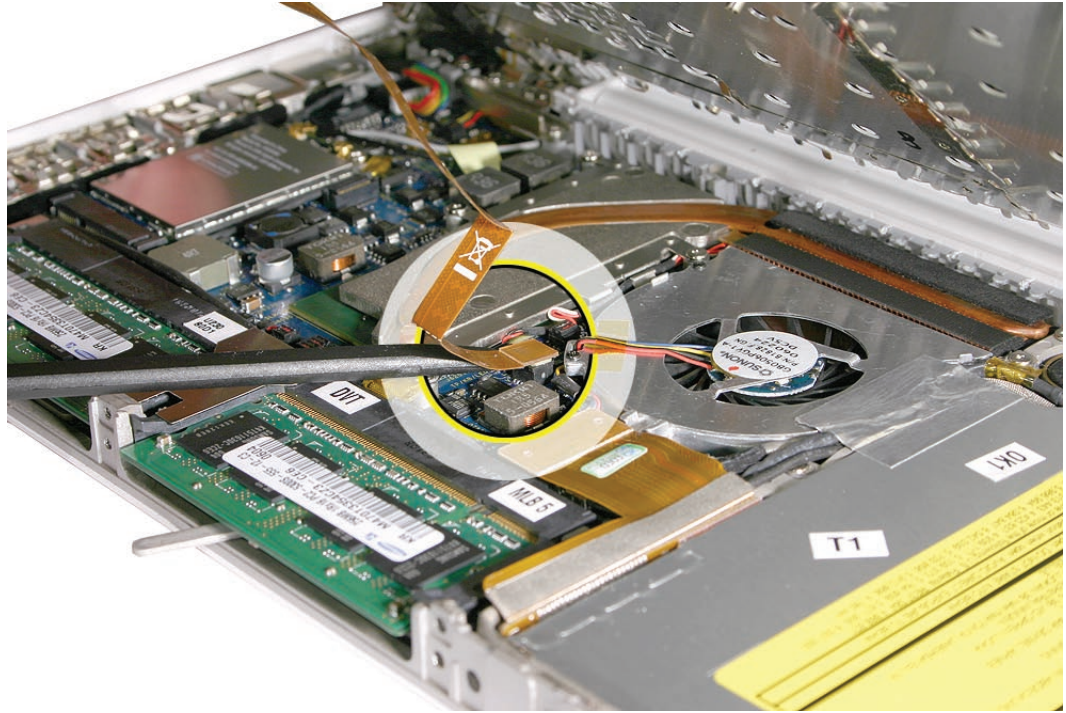

For the Late 2006 model, use the pull-tab to disconnect the trackpad cable.

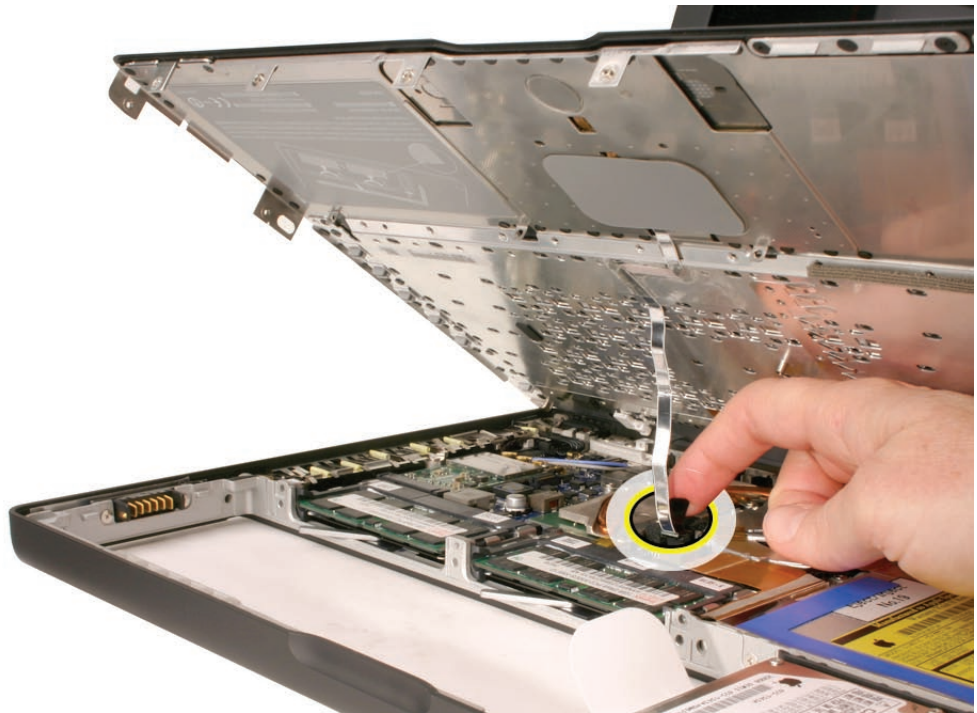

14. Lift the top case up and away from the computer assembly.

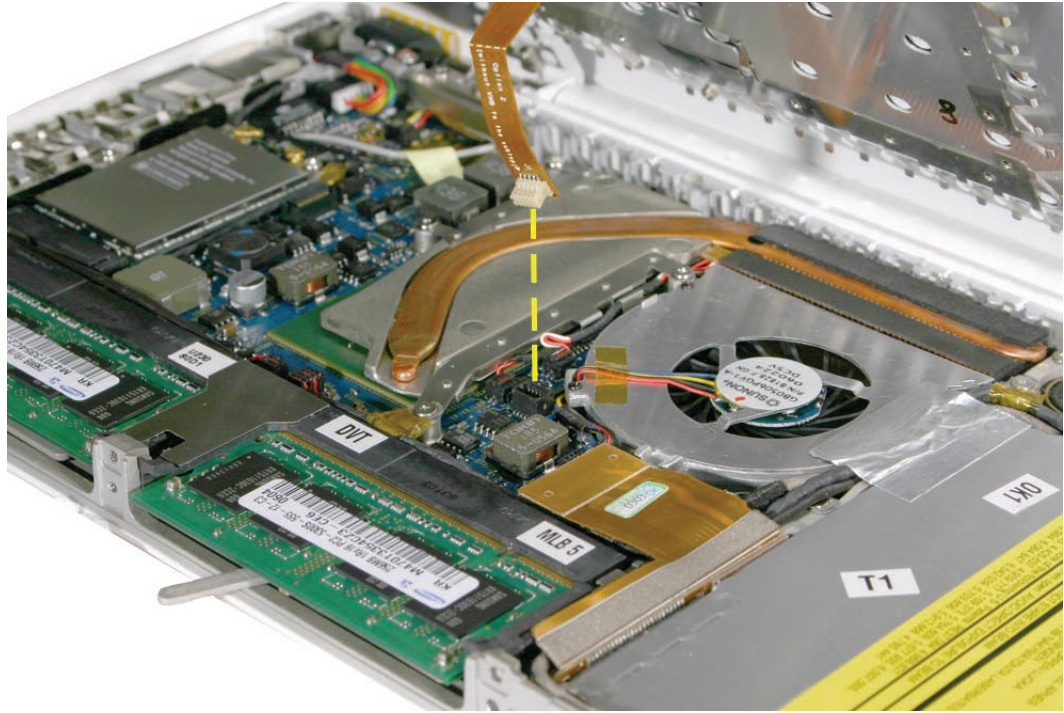

Late 2006 Model:

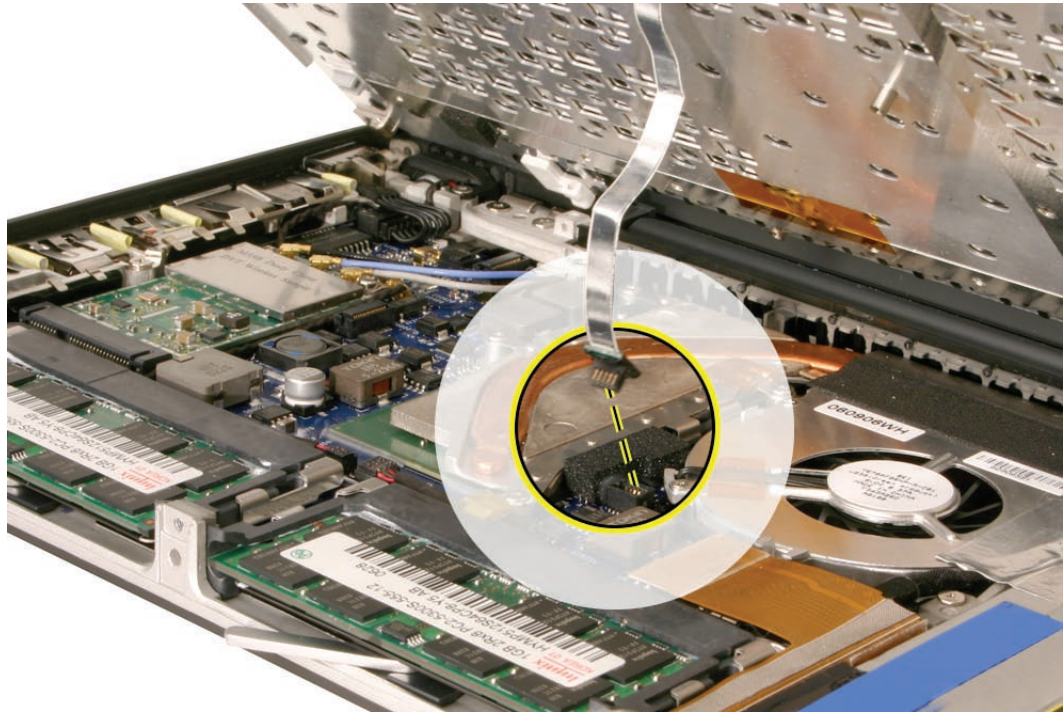

-
15. Refer to the following notes to install the replacement top case, and reassemble and test the computer.



Replacement Note: The top case includes heatstaked keyboard, webbing, EMI shield, a small rectangular foam pad, and attached trackpad cable.

Replacement Note: Before replacing the top case, make sure to connect the trackpad flex cable to the logic board.

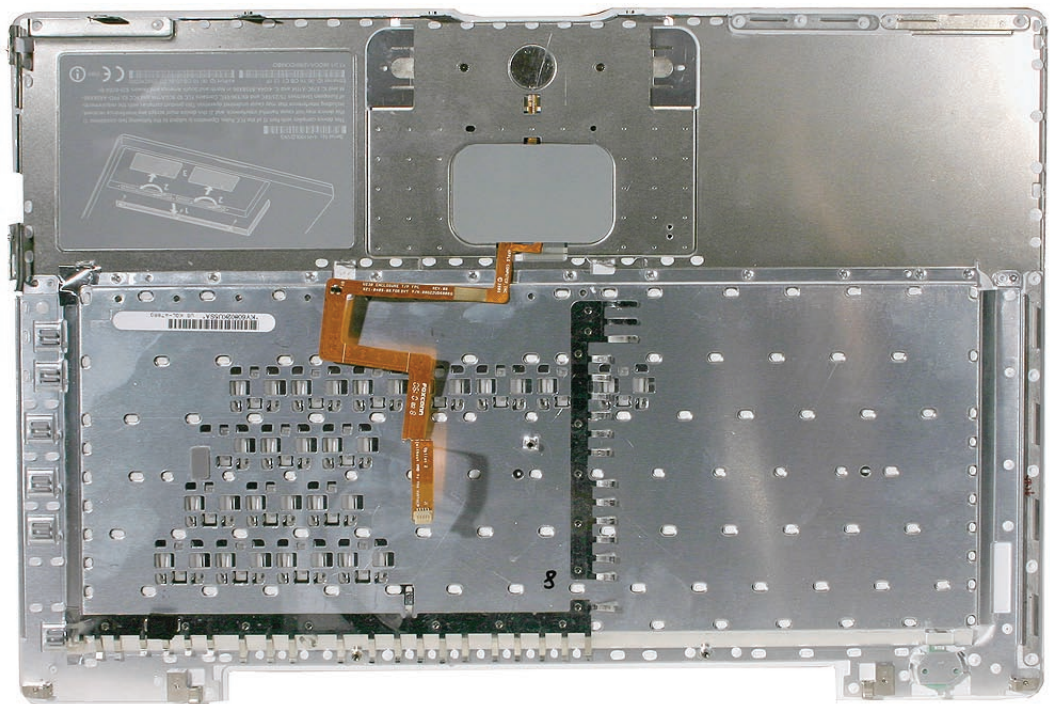

Replacement Caution: If any of the four bezel clips at the slot-load bezel come loose, simply insert them back in the slots. Make sure they are in place while reassembling the computer and before installing the top case. Install the right side of the top case first (near the disc bezel) to lock the bezel clips and prevent any of the clips from becoming loose inside the computer.

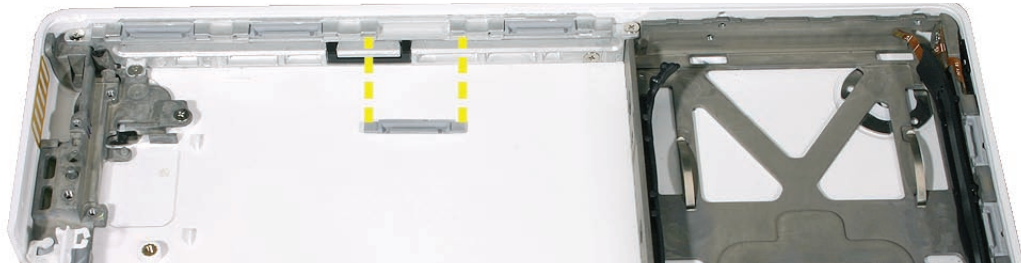

Replacement Note: Install the right side of the top case first (near the disc bezel). Then starting from the right, secure the snaps by pressing along the outer edge of the top case in a clockwise direction around the front and left side of the top case.

Replacement Caution: When installing the exterior screws and the battery bay screws, apply light pressure to the top case to ensure that the top case fits to the bottom case without any gaps.

Replacement Note: Pinch the top case to the bottom case as you secure the screws.

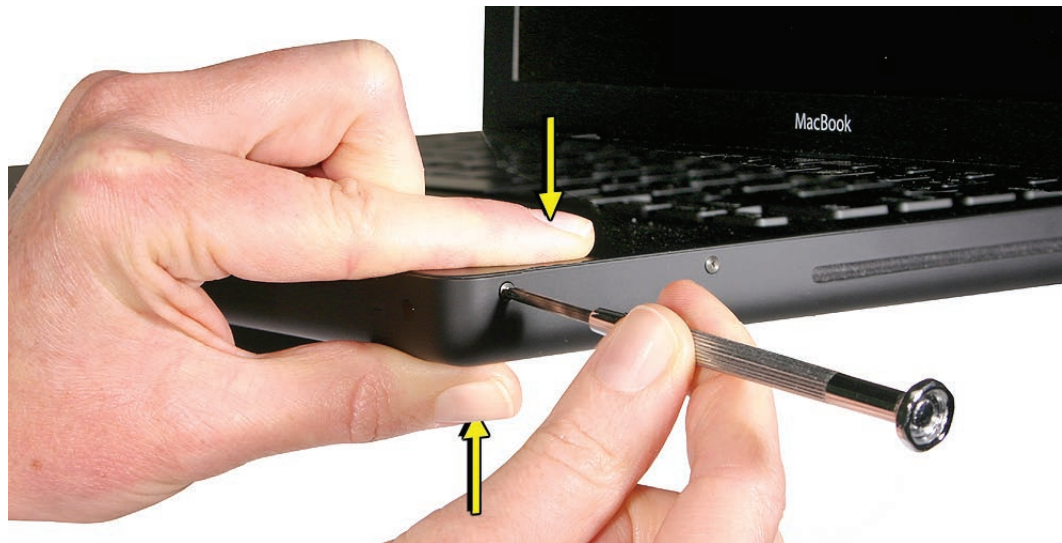

Replacement Note: When installing the screws at the rear corners of the bottom case, insert an access card tool between the top case and the display to maintain light pressure as the screws are tightened.





Trackpad Cable (Late 2006 Model Only)

Tools

- ESD wrist strap and mat
- Black stick (Apple part number 922-5065) or other nonconductive nylon or plastic flatblade tool

Preliminary Steps

Before you begin, remove

- Battery
- RAM door
- Top case

Part Location

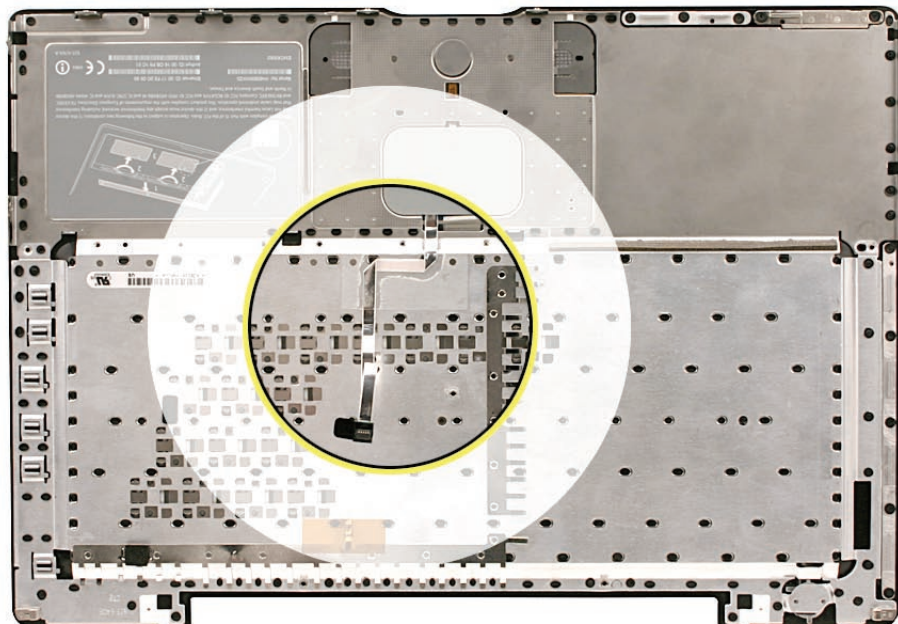

Procedure

1. Place the top case (keyboard side down) on a clean surface.
Replacement Note: Refer to the following image when attaching a replacement trackpad cable. The folds in the cable and the areas that adhere to the top case should appear as shown.

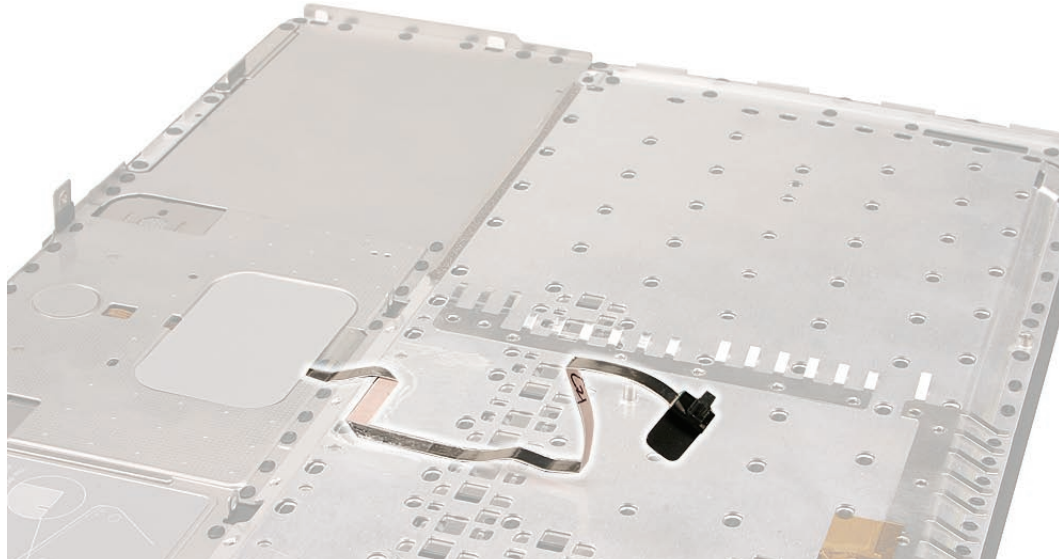

2. Use a black stick to start to peel up the clear strip of tape.

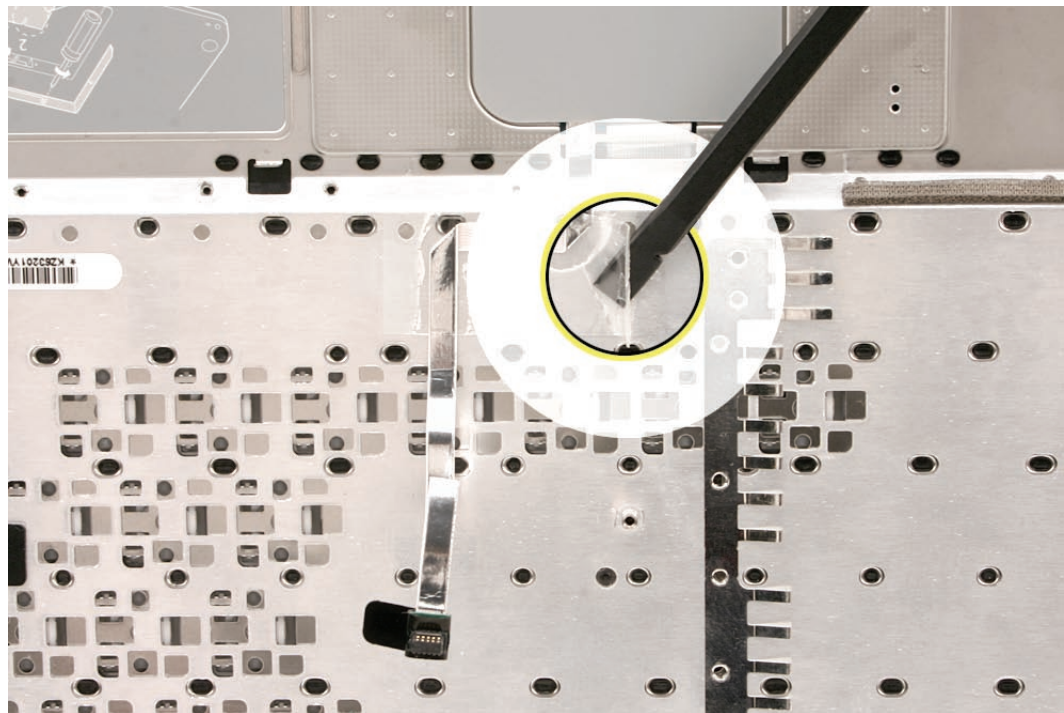

3. Hold the trackpad cable in place as you peel up—but do not remove—the tape.

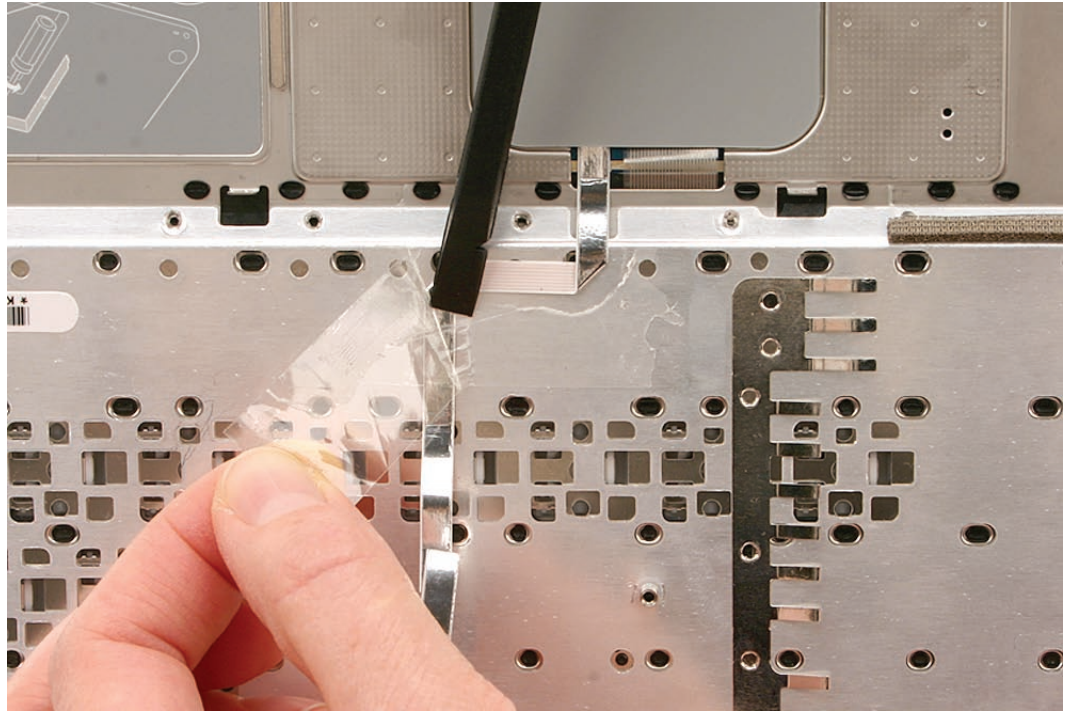

4. Peel up the mylar shield that protects the trackpad circuitry.

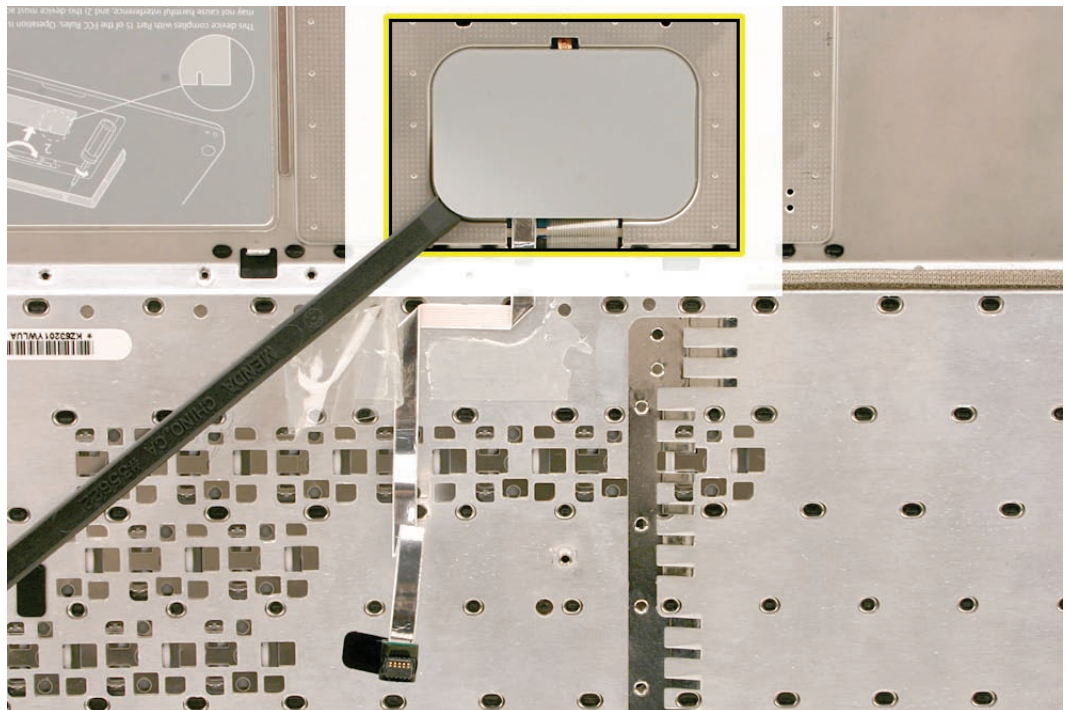

5. **Caution:** The trackpad cable locking lever at the top of the connector is fragile. Use a black stick to carefully tilt up the lever until it is vertical (as shown by the detailed image on right).
Replacement Note: When locking the trackpad cable lever, make sure it is completely closed, as shown by the detailed image on left below.

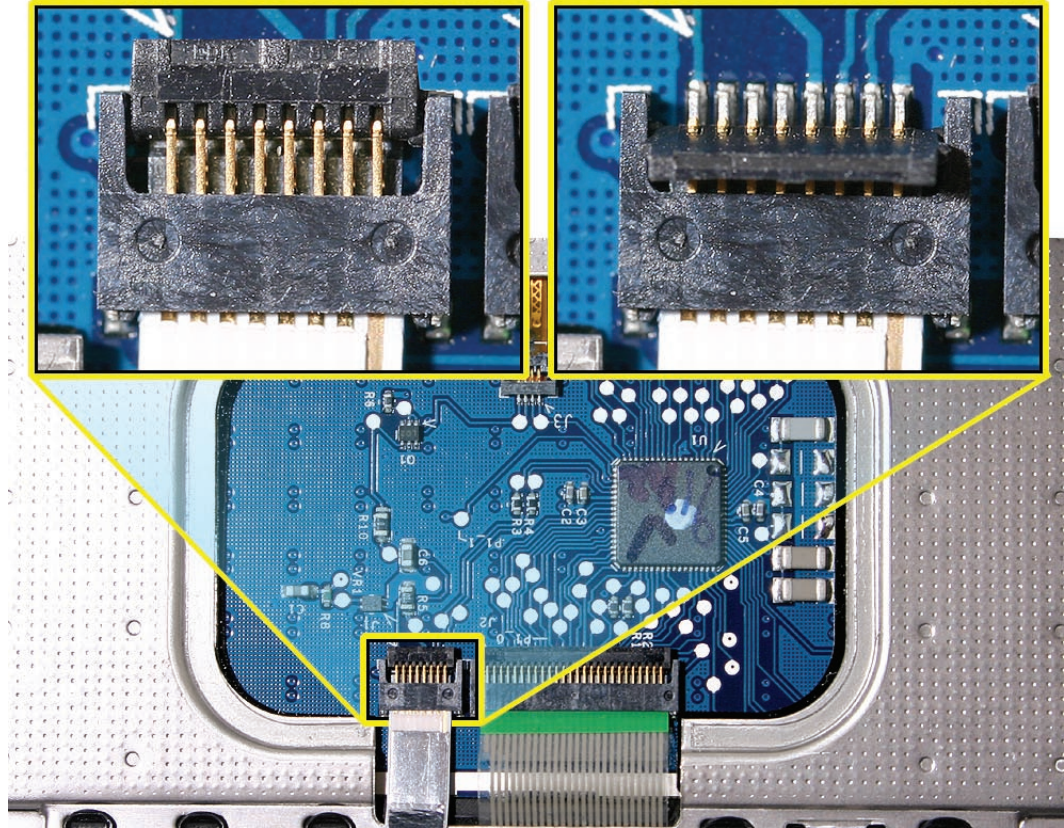

6. With the cable locking lever open, pull the cable down to remove it from the connector.
7. Carefully peel up the trackpad cable from where it adheres to the underside of the top case.

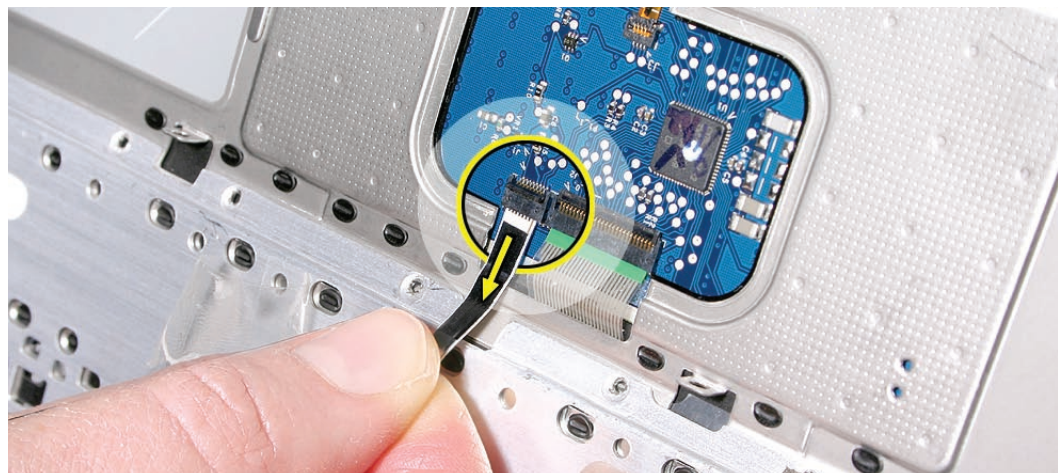

-
8. Install the replacement trackpad cable, and reassemble and test the computer.





AirPort Extreme Card

Tools

- ESD wrist strap and mat
- Black stick (Apple part number 922-5065) or other nonconductive nylon or plastic flatblade tool
- Magnetic Phillips #0 screwdriver

Preliminary Steps

Before you begin, remove

- Battery
- RAM door
- Top case with keyboard

Part Location

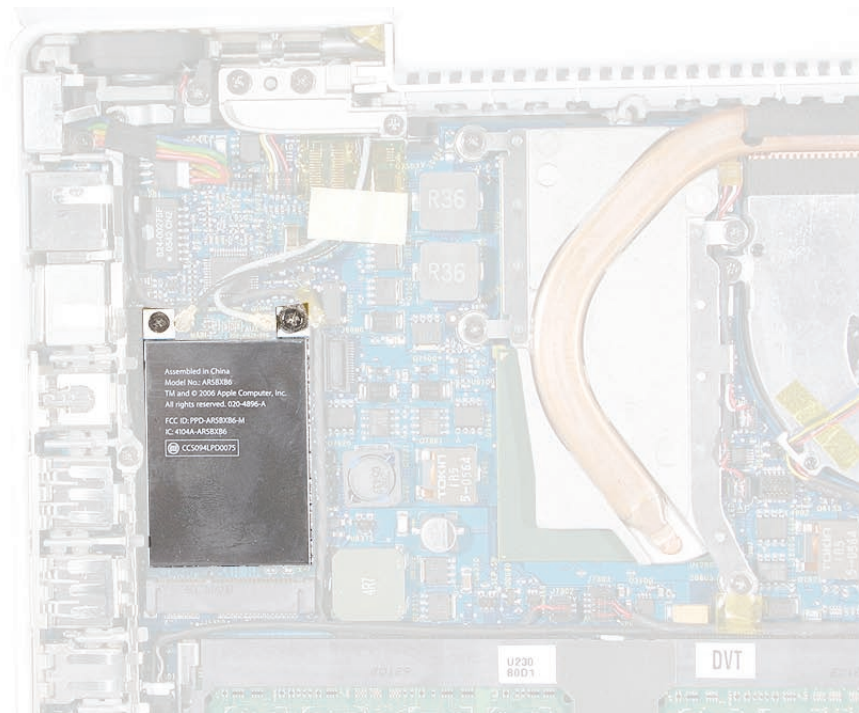

Procedure

1. Remove the 8.5-mm long screw (that also functions as the left speaker cable ground pin) from the upper right corner of the board. (The thick head on this screw helps identify it.)
2. Remove the 3-mm long screw from the upper left corner of the board.

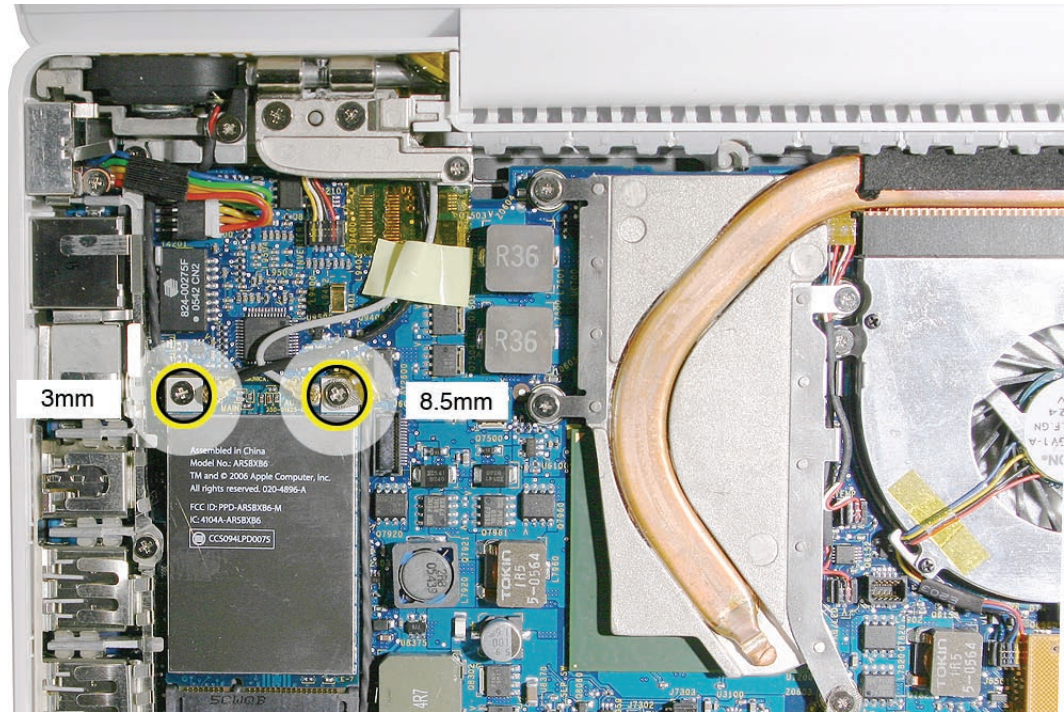

3. Pull the card up slightly and out of the card socket on the logic board.

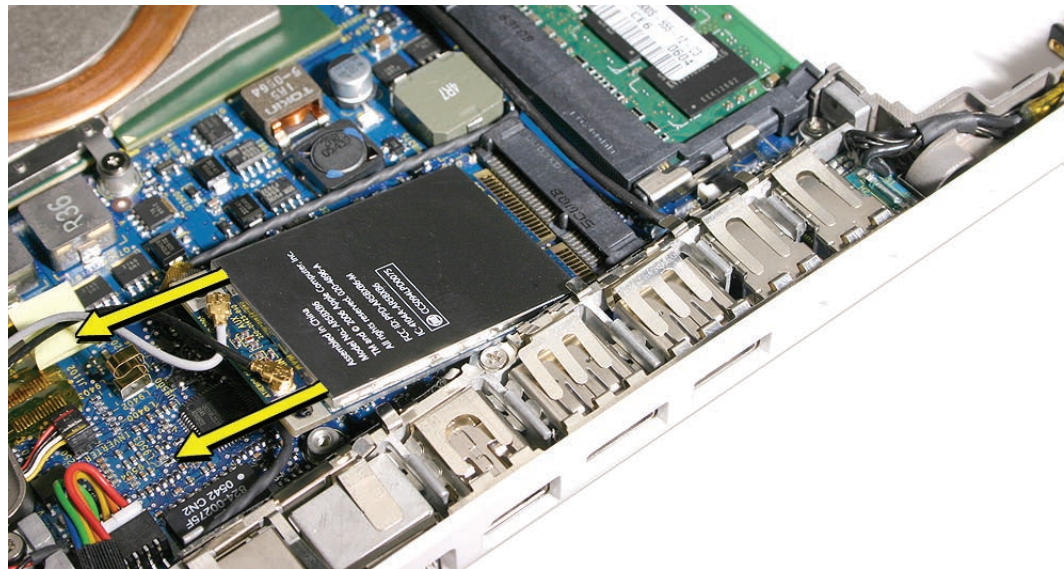

4. Use a black stick to move aside the speaker cable.
5. Disconnect the two cables from the AirPort Card. Note that the black cable is on the left and the gray cable is on the right.

Tip: To remember the cable locations, think “Left = bLack; Right = gRay.”

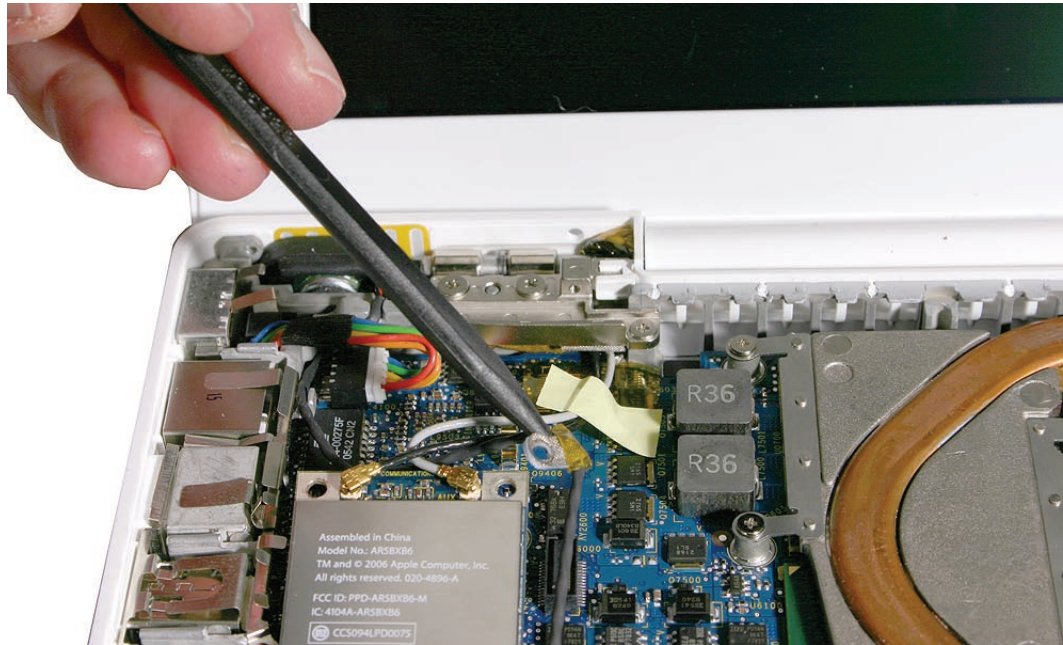

Late 2006 Model: This model has three antenna cables. Disconnect the black, blue, and gray cables.

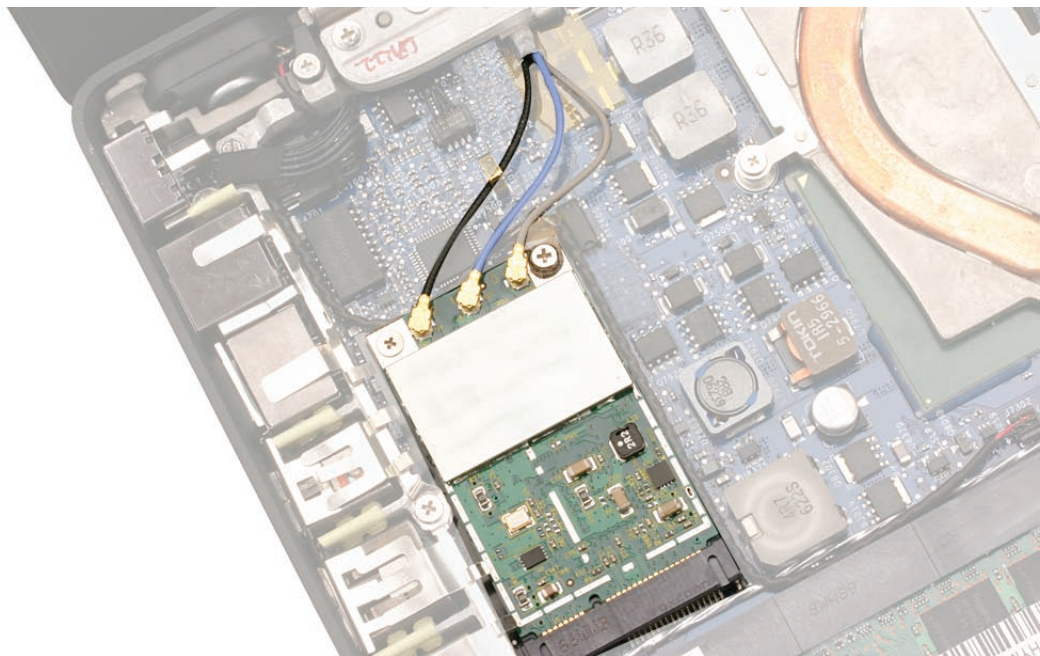

6. Install the replacement AirPort Card, and reassemble and test the computer.

Replacement Note: If the computer model that you are servicing includes tape over the antenna cables, reapply the tape where shown.

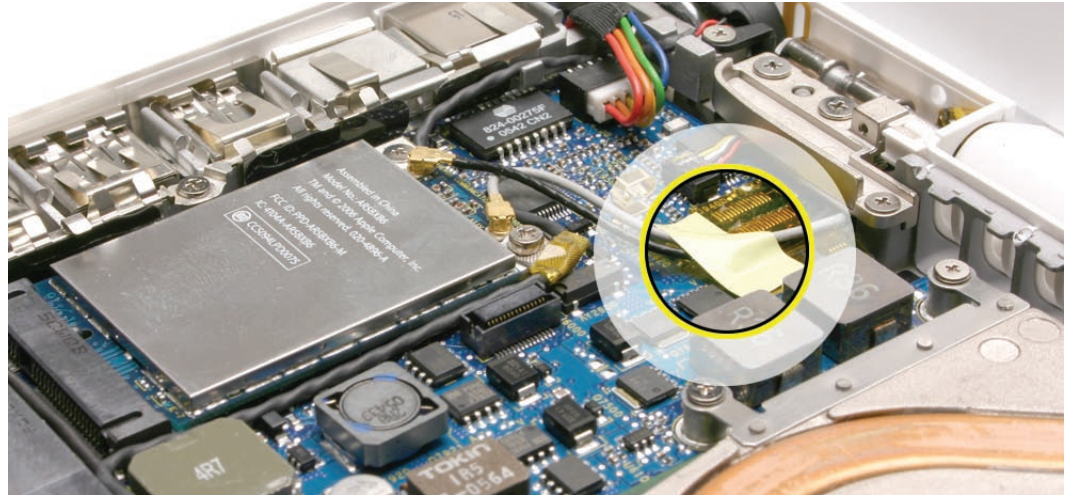

Late 2006 Model Replacement Note: Notice that the AirPort Card has numbers 2, 1, and 0 printed on the card. The numbers correspond to the antenna cable colors where 2 = black, 1 = blue, and 0 = gray.

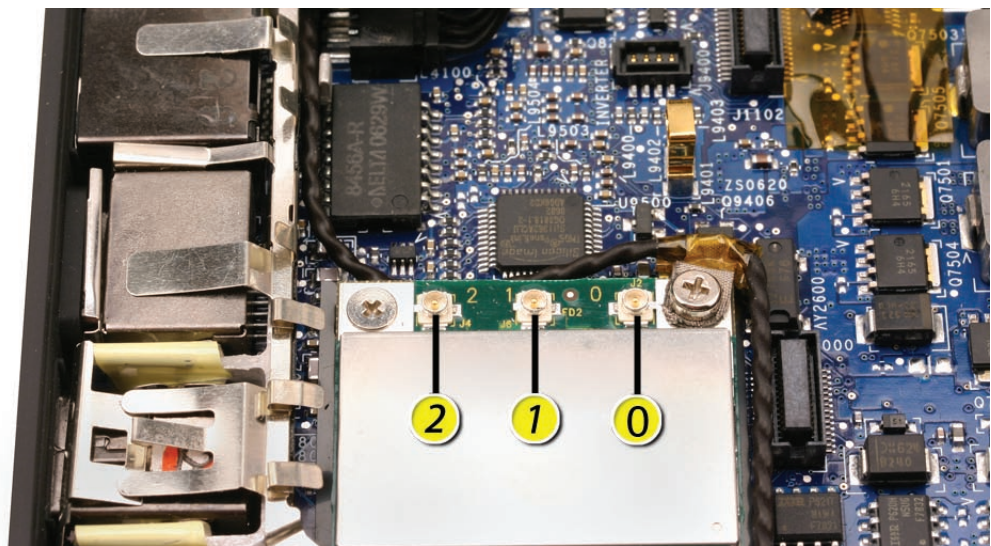

Replacement Caution: When connecting the AirPort antenna cables, make sure the cables do not obstruct the gold-colored spring on the logic board. If one of the cables were caught in the folds of the spring, the cable or spring could be damaged when the top case was installed.

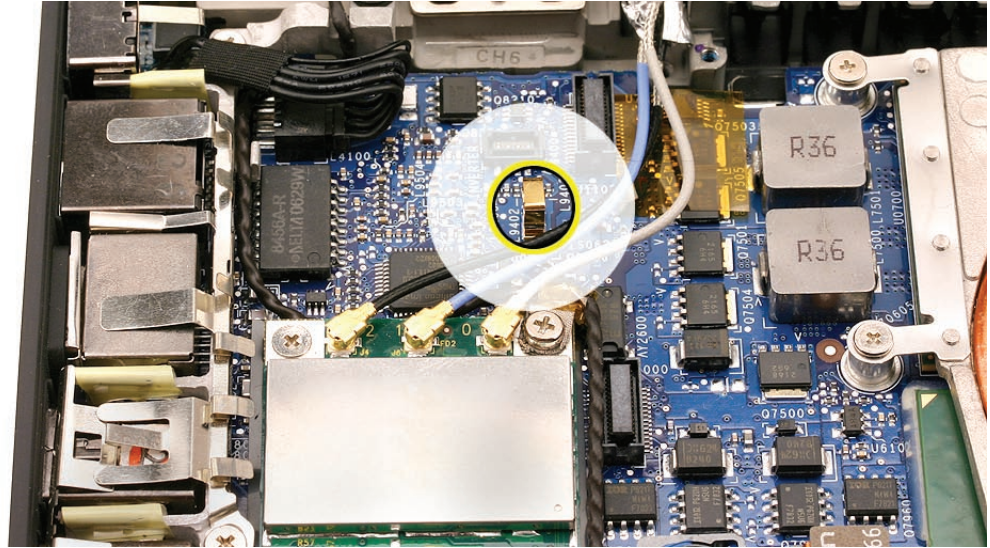



MagSafe DC-In Board

Tools

- ESD wrist strap and mat
- Magnetic Phillips #0 screwdriver
- Black stick (Apple part number 922-5065) or other nonconductive nylon or plastic flatblade tool

Preliminary Steps

Before you begin, remove

- Battery
- RAM door
- Top case with keyboard

Part Location



Procedure

1. Place a black stick under the DC-in connector cables to help disconnect the connector, then pull the connector away from its connection on the logic board. (Note: Although the cables are solid black on the Late 2006 model, the steps are the same.)

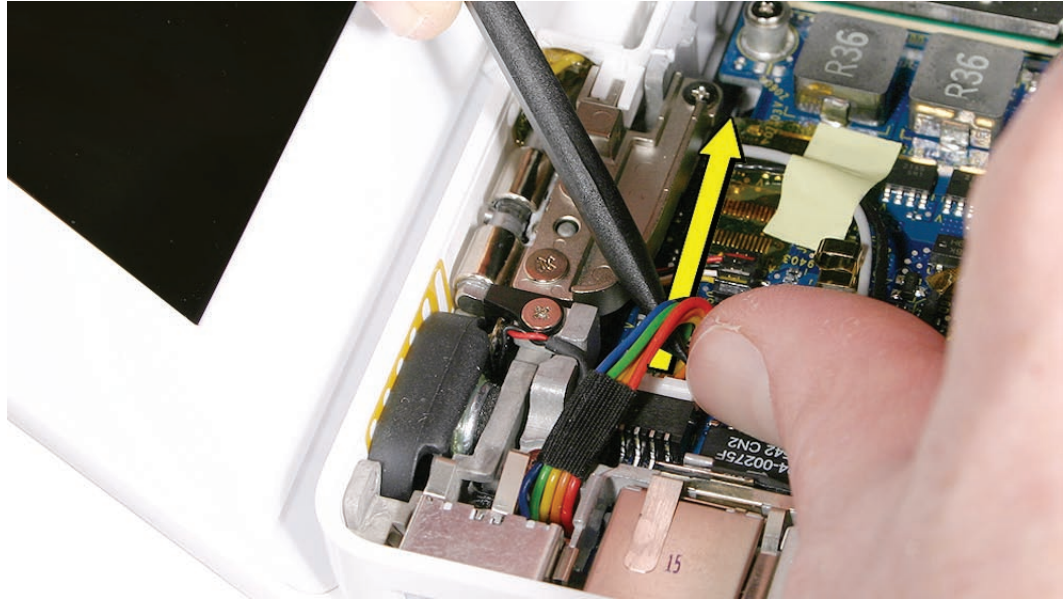

2. Remove the 3-mm long screw from the MagSafe DC-in board.

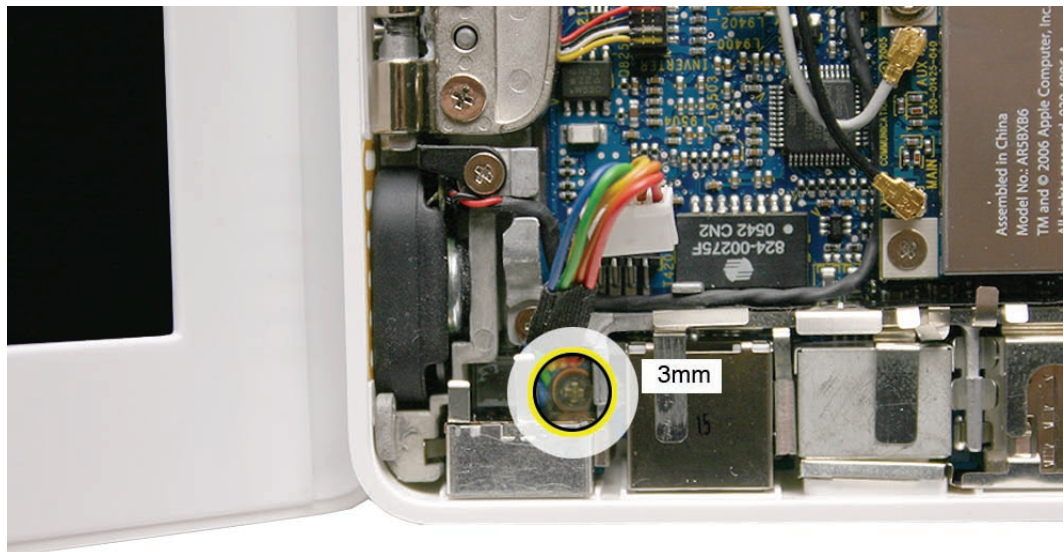

Caution: The DC-in port is magnetic. Be careful that it doesn't pick up screws or other small parts.

3. From the port side, use a black stick to help tilt up the MagSafe DC-in board and remove it from the logic board.

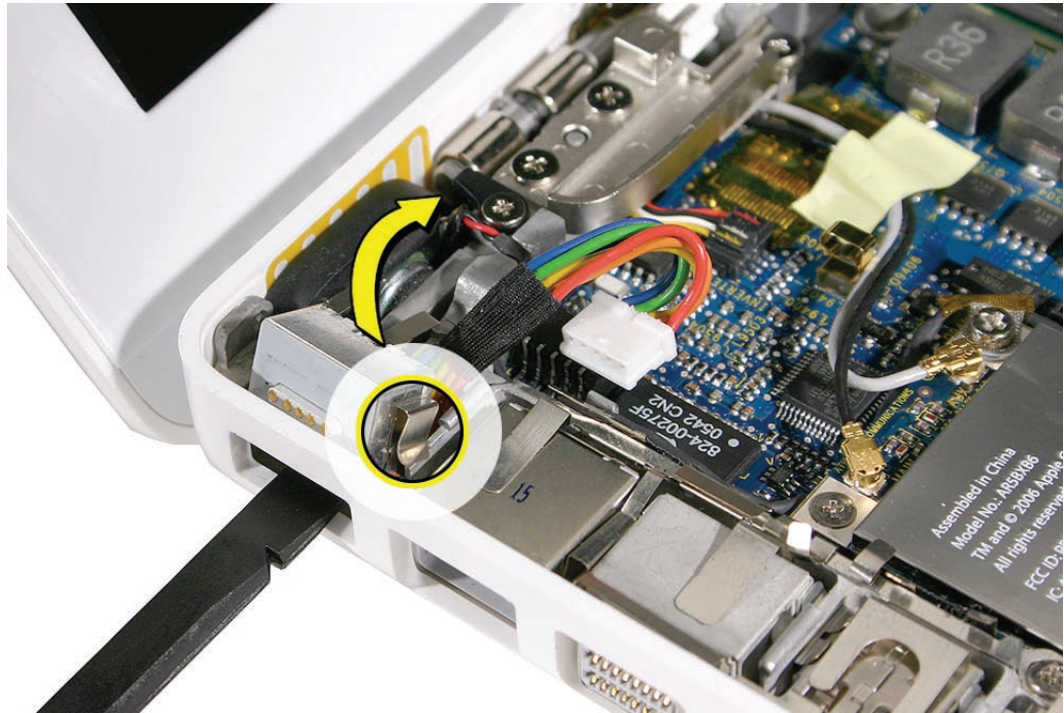

Replacement Note: Make sure the folded side of the EMI shield fits over the I/O frame rib so that the rib is sandwiched between the flanges of the EMI shield.

Replacement Note: If installing a new MagSafe DC-in board, first peel off the protective membrane from the MagSafe DC-in board. Then connect the DC-in cable to the connector on the logic board, and insert the board into the upper left corner of the bottom case. Finally, install the screw.

-
4. Install the replacement MagSafe DC-in board, and reassemble and test the computer.

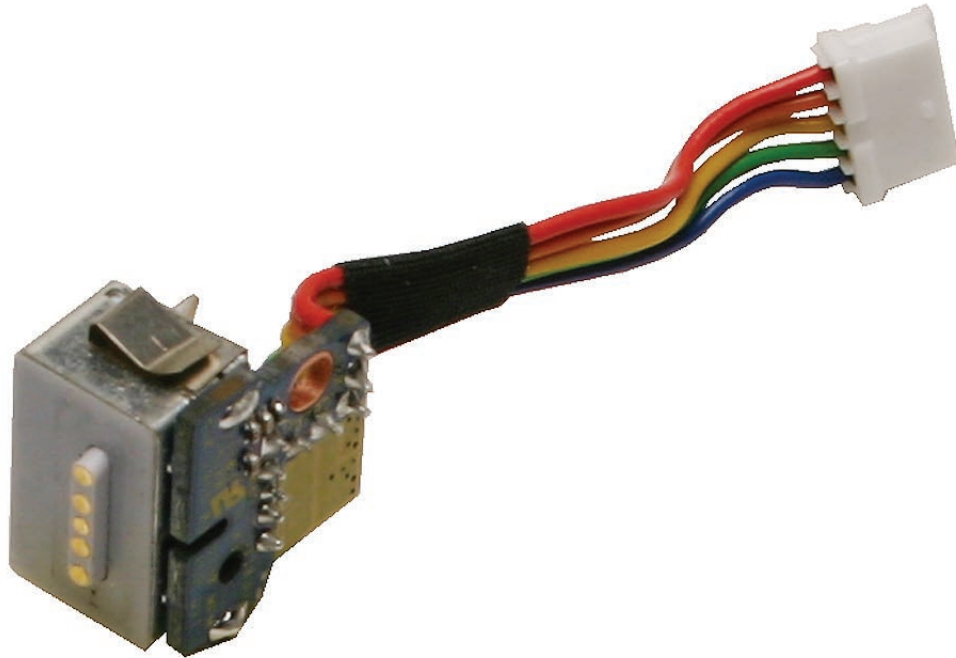

Replacement Note: Check that there are no bent EMI fingers on the shield covering the port area.

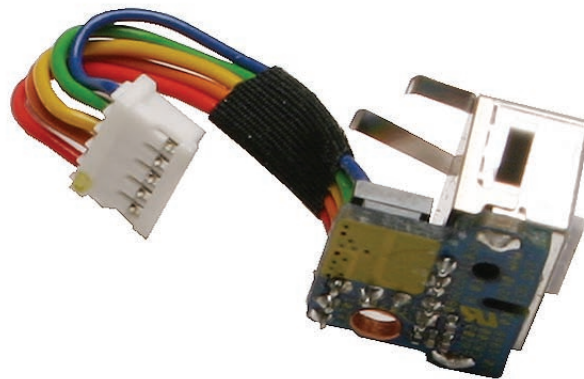

Replacement Note: Check the port side of the bottom case to make sure the MagSafe DC-in port is level with the port opening.





Left Speaker

Tools

- ESD wrist strap and mat
- Magnetic Phillips #0 screwdriver
- Black stick (Apple part number 922-5065) or other nonconductive nylon or plastic flatblade tool

Preliminary Steps

Before you begin, remove

- Battery
- RAM door
- Top case with keyboard

Part Location

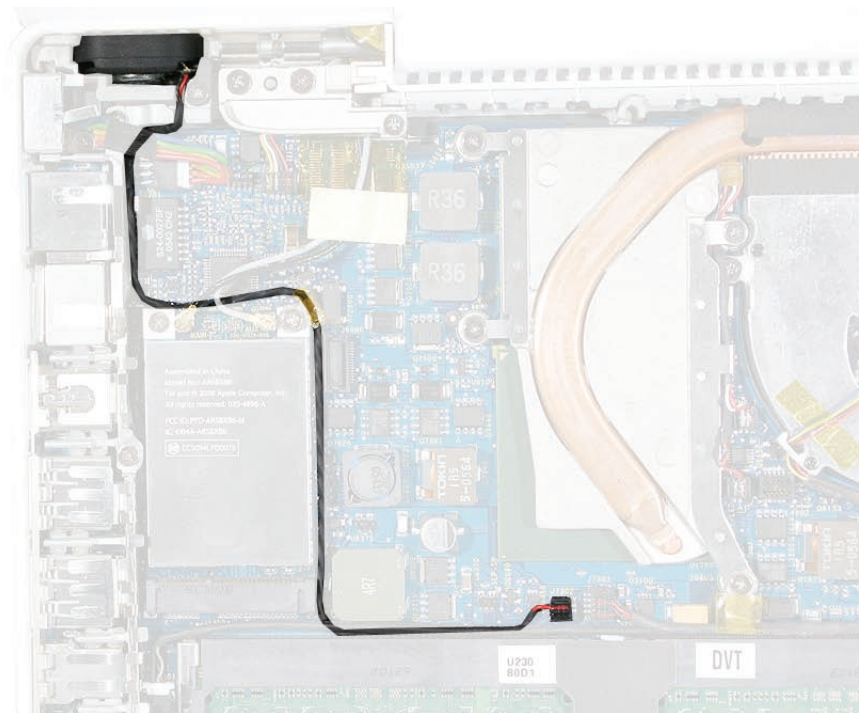

Procedure

1. Disconnect the speaker cable from the logic board.
2. Remove the 8.5-mm long ground screw at the upper right corner of the AirPort Extreme Card.

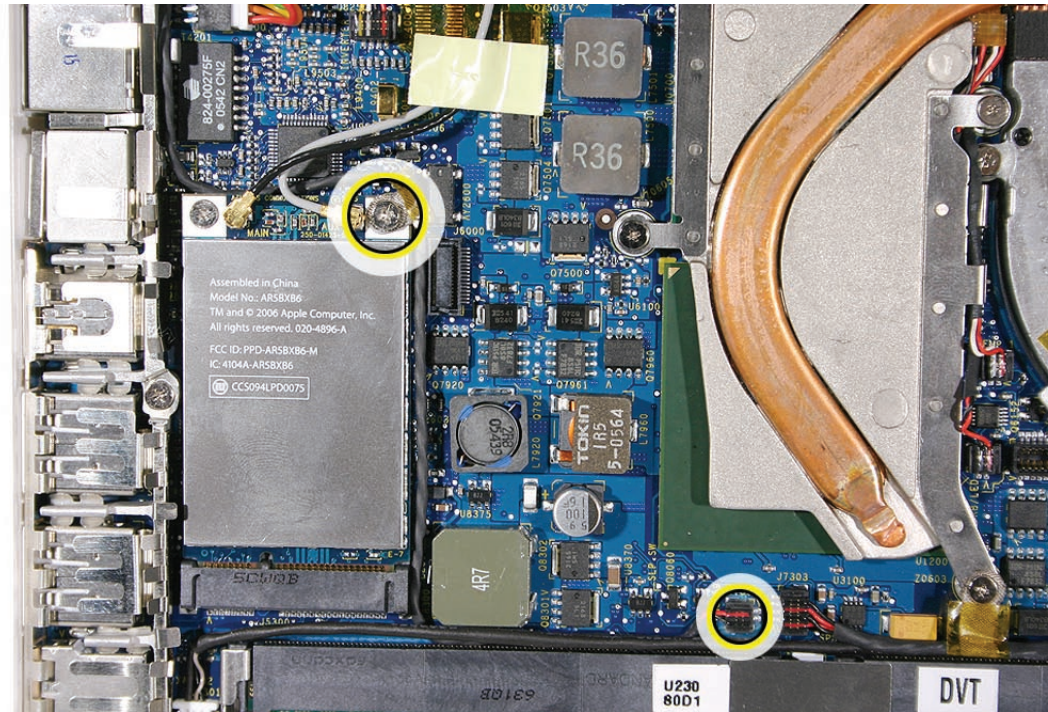

3. Route the cable underneath the AirPort cables.

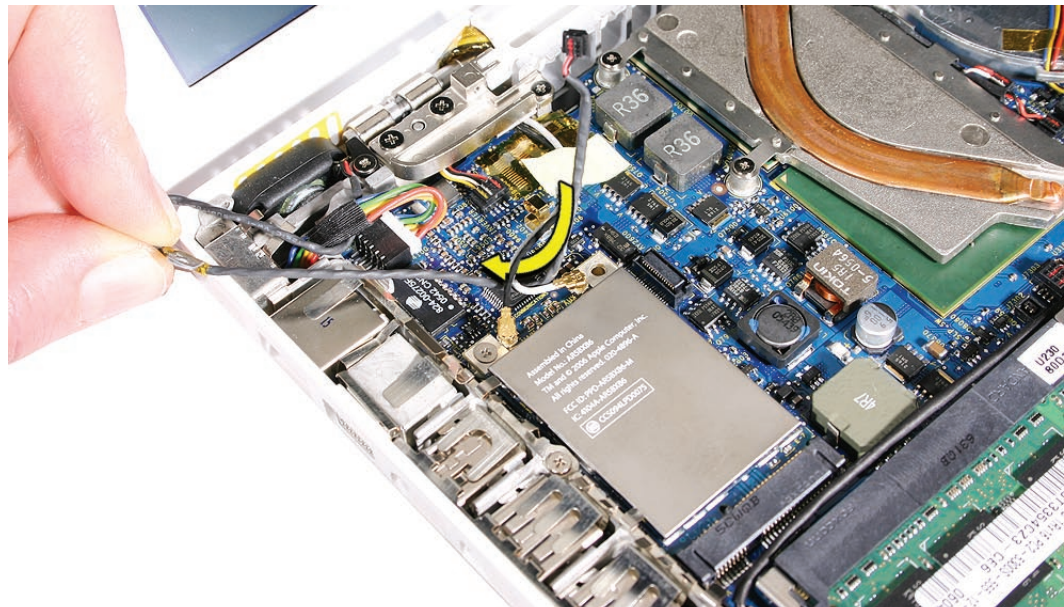

4. Remove the 6-mm long speaker screw.

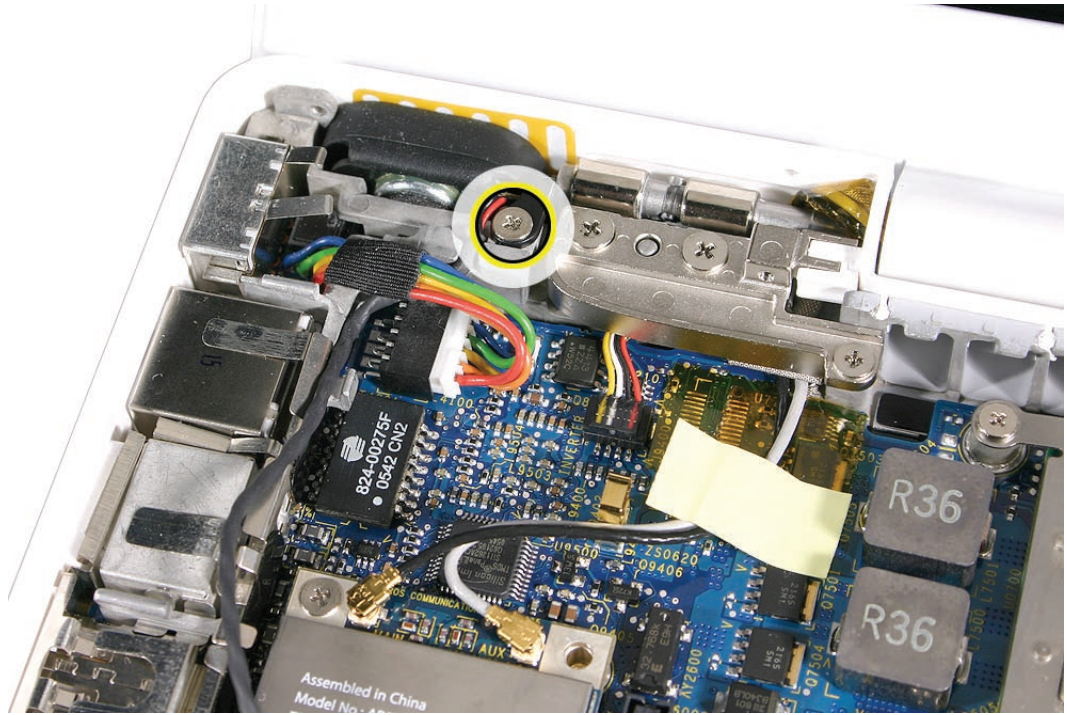

5. Pull up on the speaker cable to remove it from the frame.
6. Pivot up the speaker from the left corner.

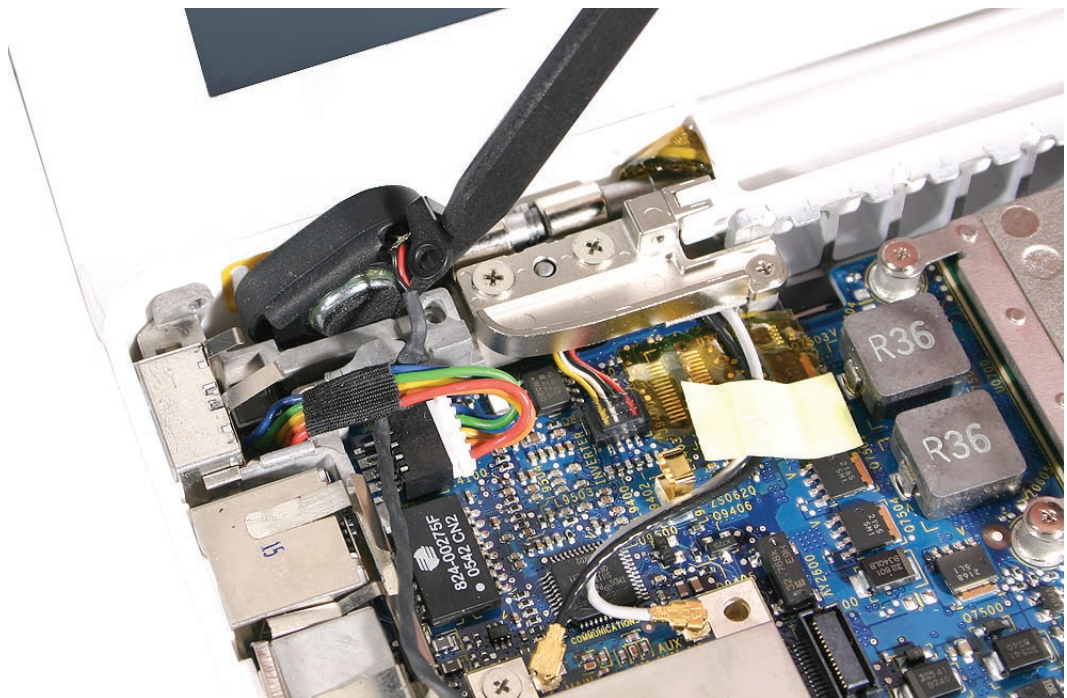

7. Route the speaker cable underneath the DC-in cable.



8. Install the replacement speaker cable, and reassemble and test the computer.
Replacement Note: To prevent a pinched cable, make sure the cable is routed as shown.

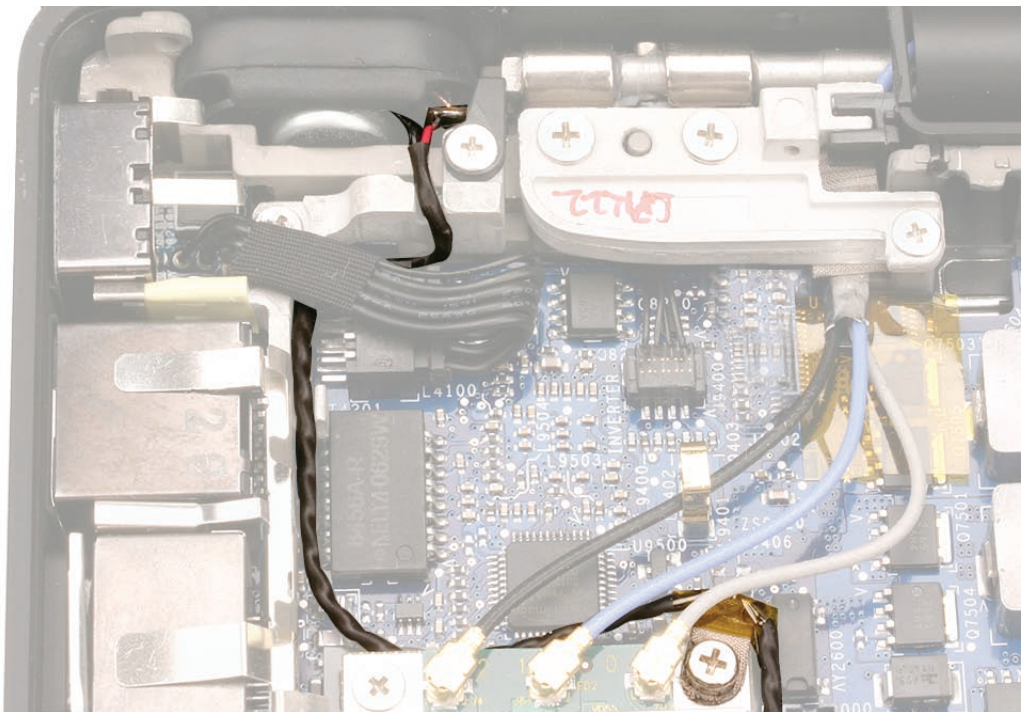



Battery Connector with Sleep Switch

Tools

- ESD wrist strap and mat
- Magnetic Phillips #0 screwdriver
- Black stick (Apple part number 922-5065) or other nonconductive nylon or plastic flatblade tool

Preliminary Steps

Before you begin, remove

- Battery
- RAM door
- Top case with keyboard

Part Location

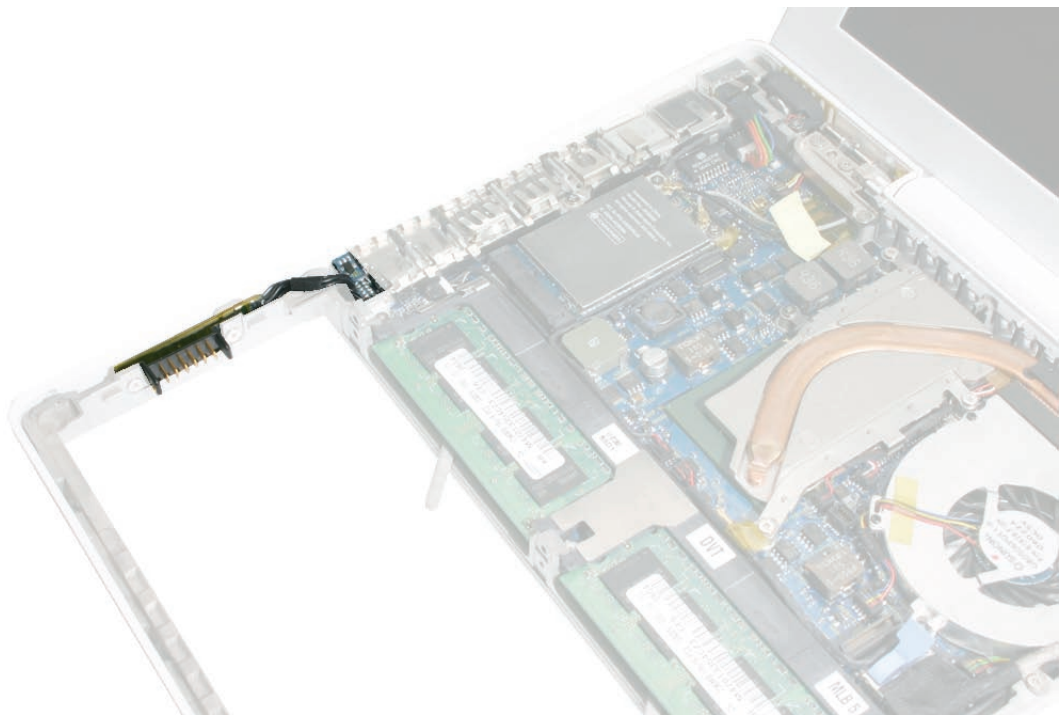

Procedure

Caution: Do not touch the raised section of the sleep switch connector. It is fragile and could break.

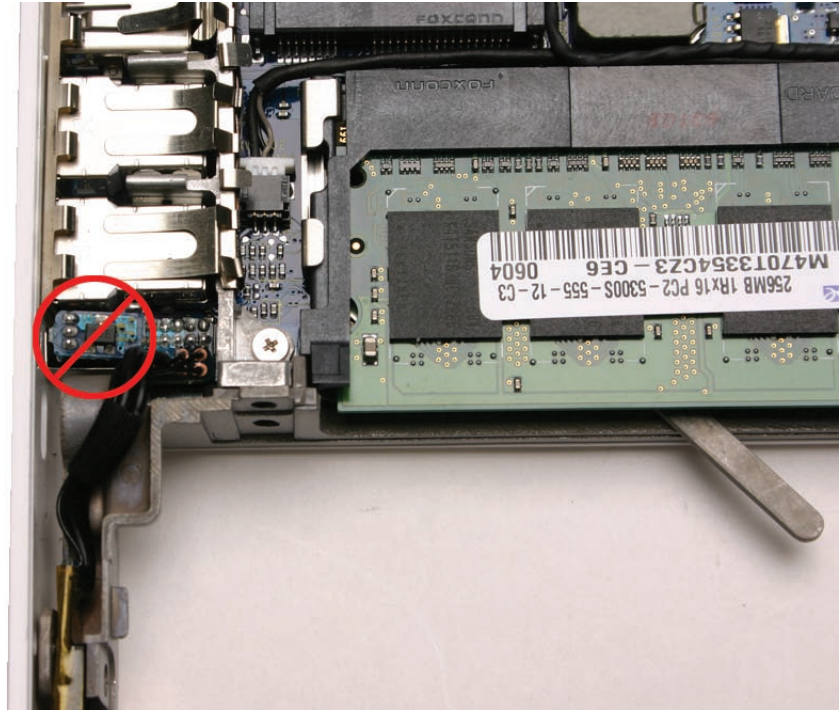

1. Remove the two 4.5-mm long shoulder screws from the frame at the battery connector.

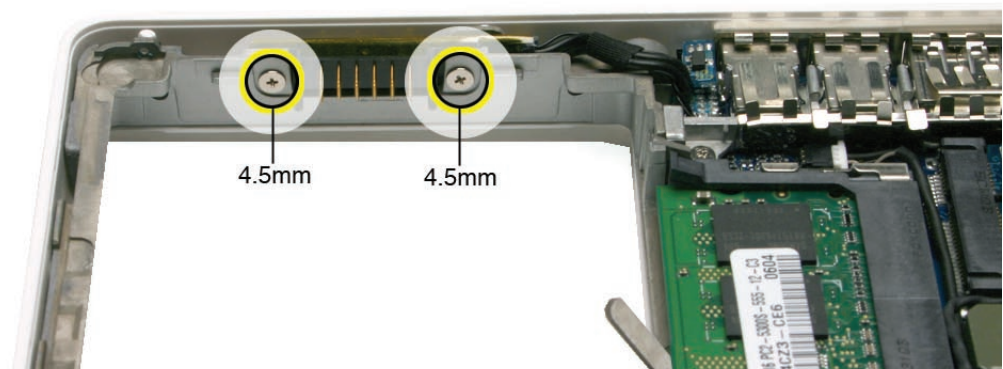

Replacement Caution: Make sure the screws are the proper length. A longer screw could damage the board.

2. Tilt up the battery connector end of the board.

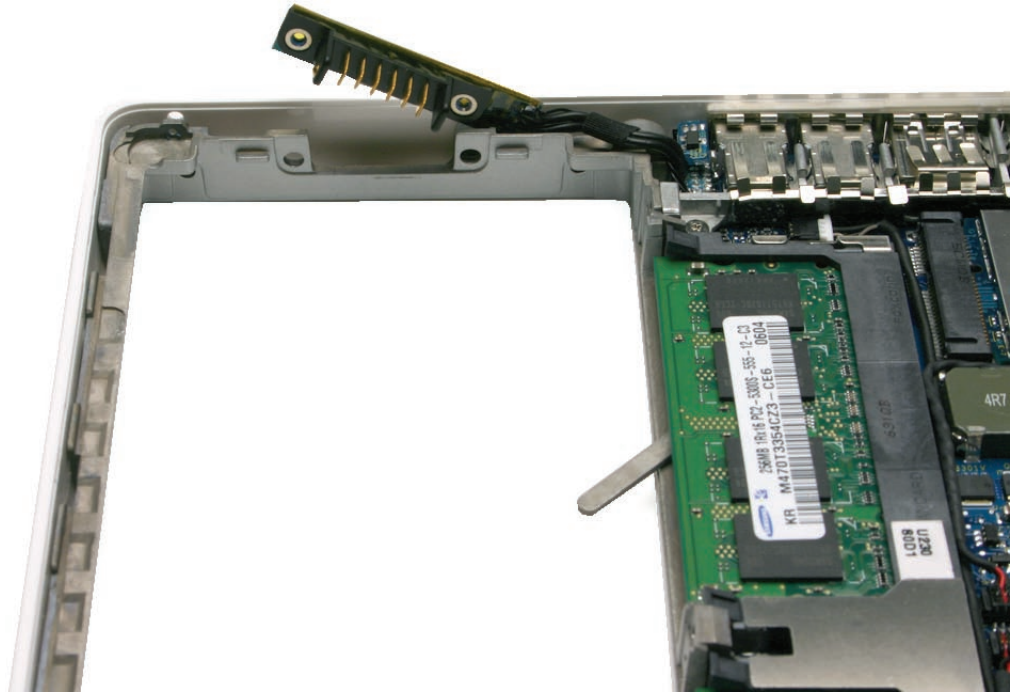

3. If provided, remove the single screw that secures the battery cable clip to the I/O frame.

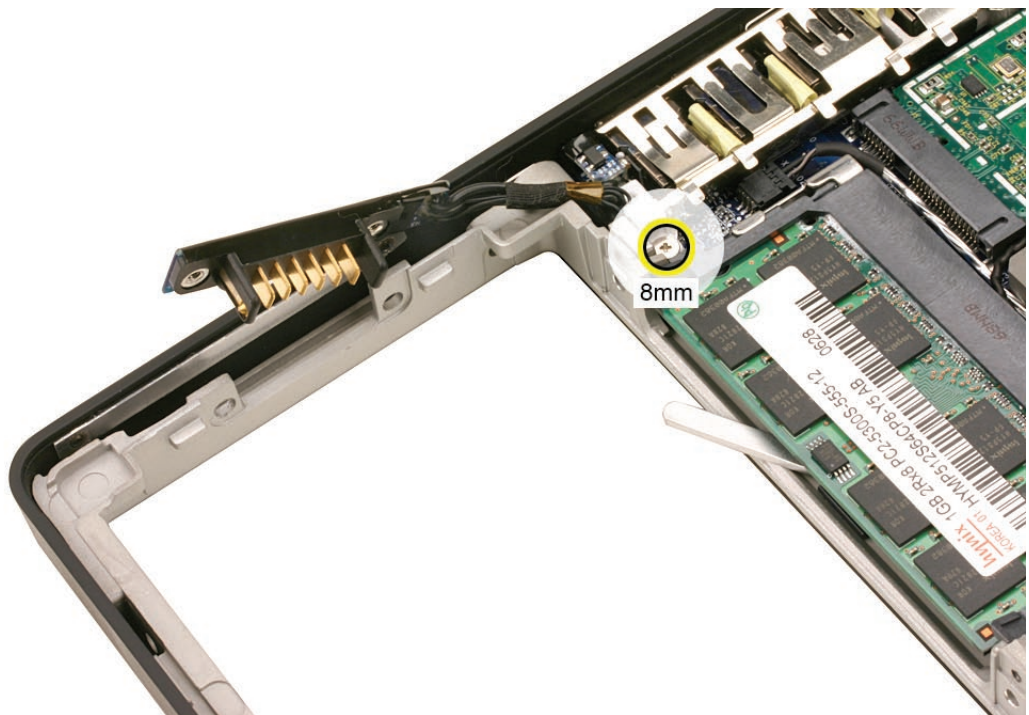

4. Tilt up the battery cable clip, and remove it from the computer assembly.

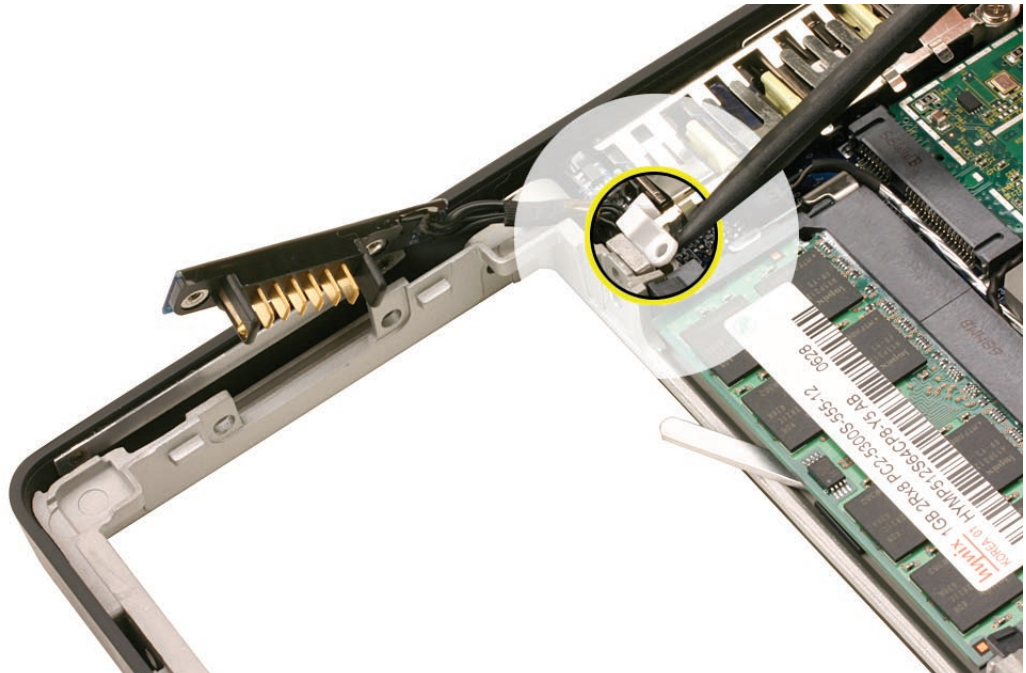

Replacement Note: Be sure to install the battery cable clip when reassembling the computer.

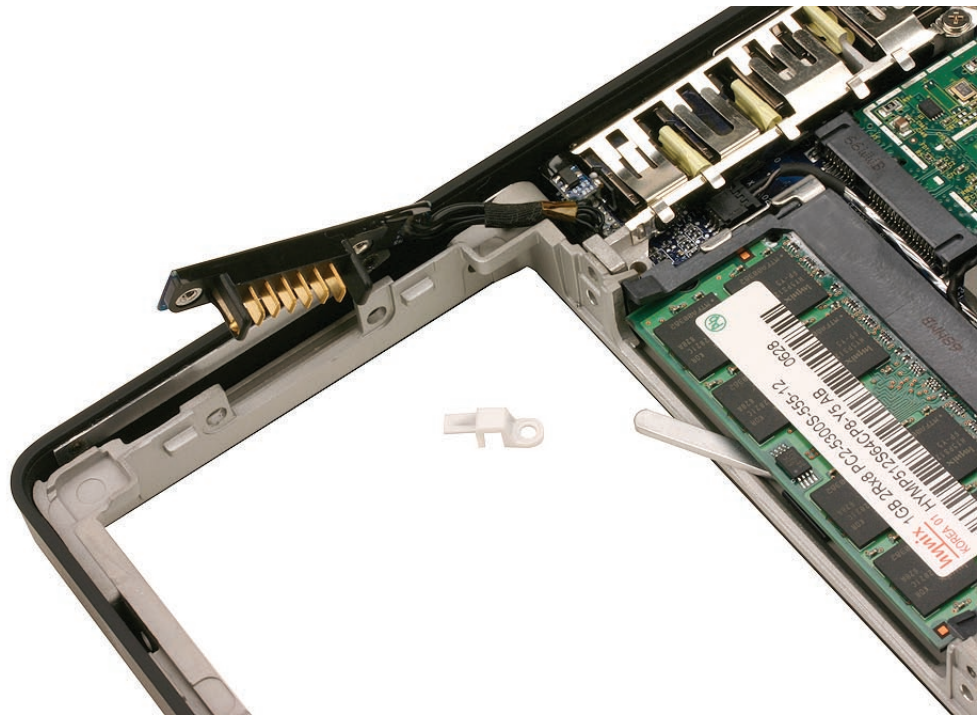

5. **Caution:** Do not touch the raised section of the sleep switch connector. It is fragile and could break. Using a black stick, insert it under the cables, and lift up the connector from the logic board.

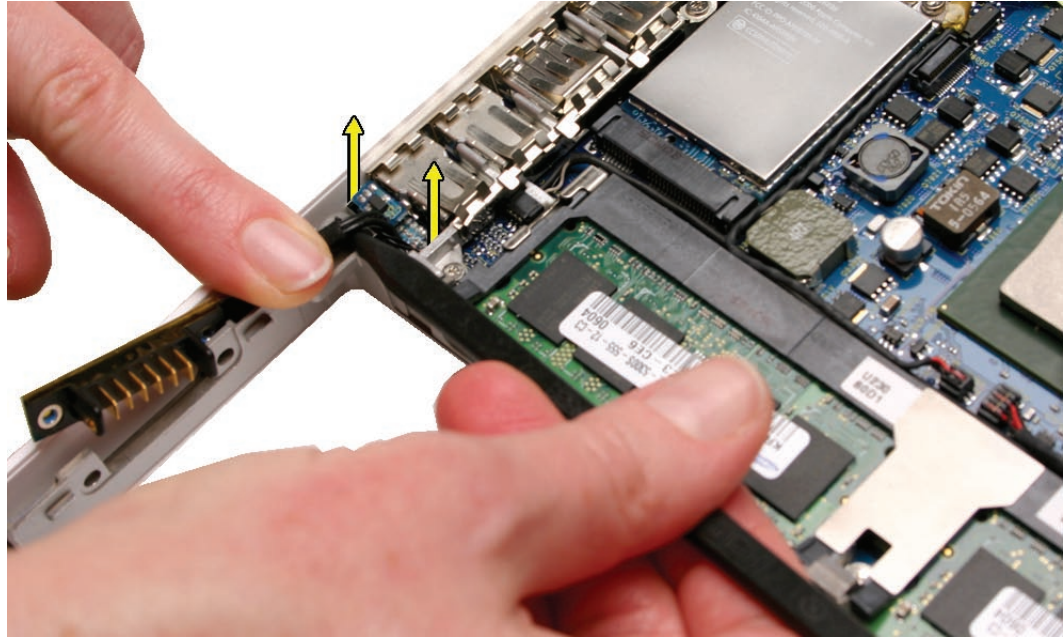

Replacement Note: To avoid bending the pins on the sleep switch connector card, make sure you squarely align the pins over the logic board and keep the connector card level when installing it. Install the “pins” end of the sleep switch connector first; then install the battery connector and screws.

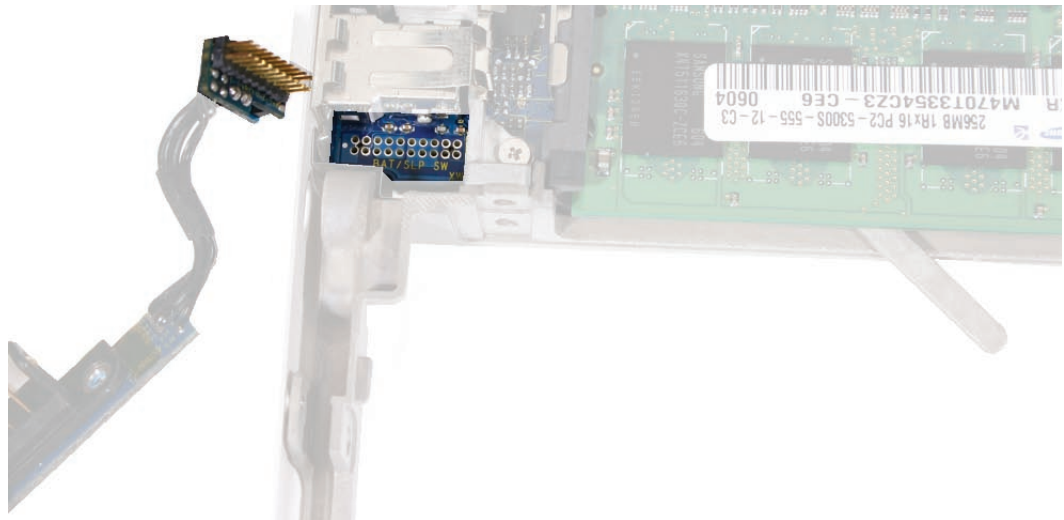

6. Install the replacement battery connector with sleep switch, and reassemble and test the computer.

Caution: To avoid pinching the cable, the battery connector cable must be properly tucked into the cable channel, as shown by the image on the left, below:

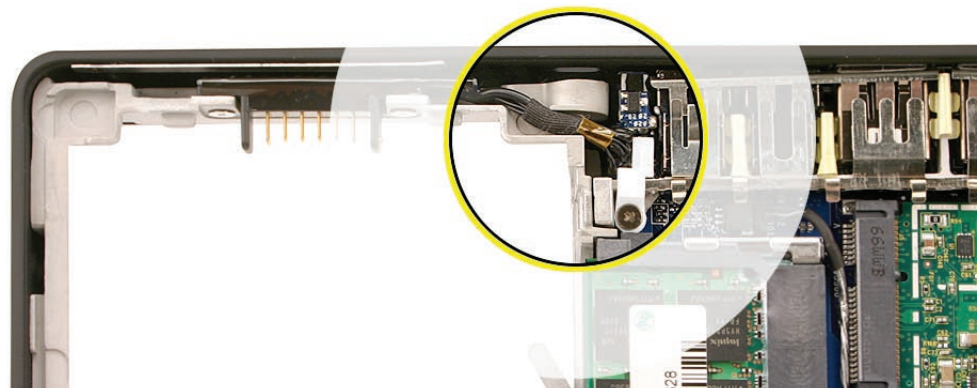
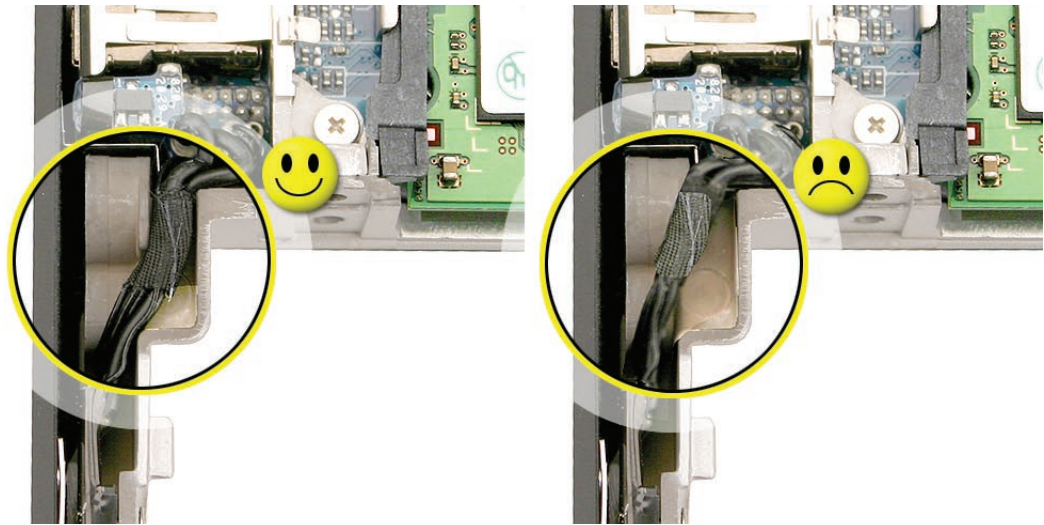

Replacement Note: Check that the battery connector can be wiggled to allow for movement of the battery. If the connector is completely still when grasped, loosen the screws slightly.

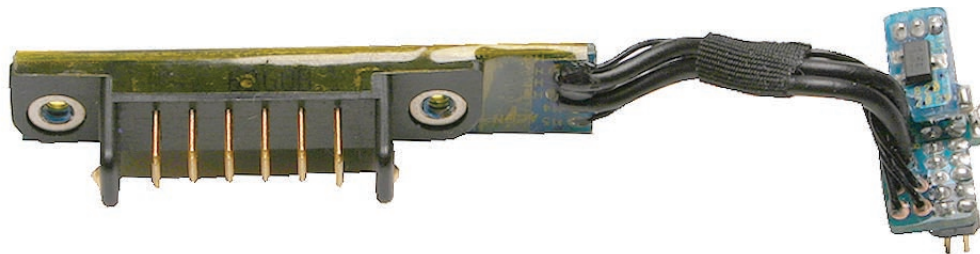



Hard Drive Connector

Tools

- ESD wrist strap and mat
- Magnetic Phillips #0 screwdriver
- Black stick (Apple part number 922-5065) or other nonconductive nylon or plastic flatblade tool

Preliminary Steps

Before you begin, remove

- Battery
- RAM door
- Hard drive
- Top case with keyboard

Part Location

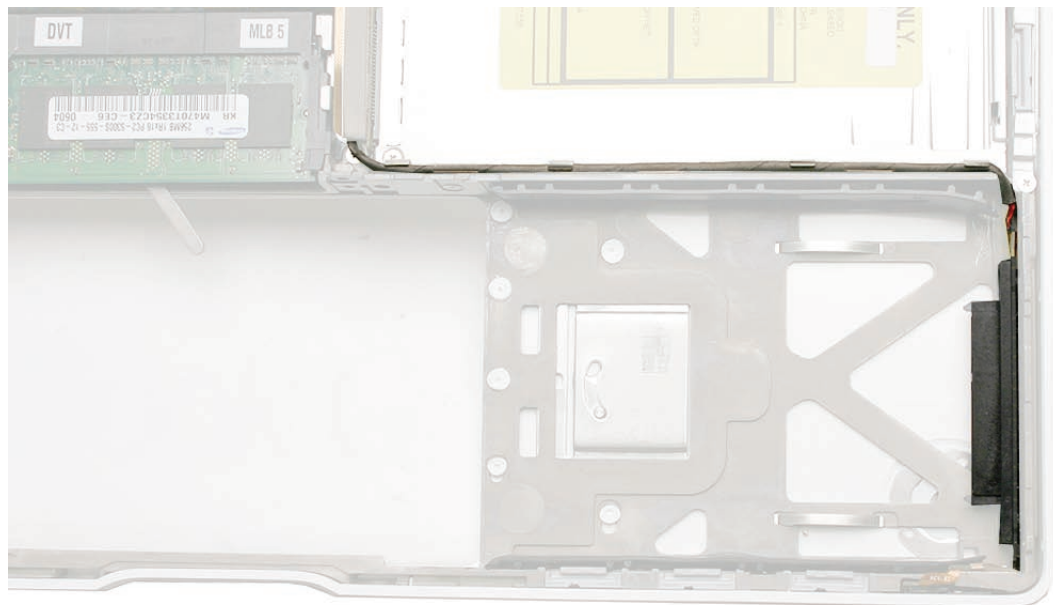

Procedure

1. Remove the two 6-mm long screws from the hard drive connector at the right front side of the computer.

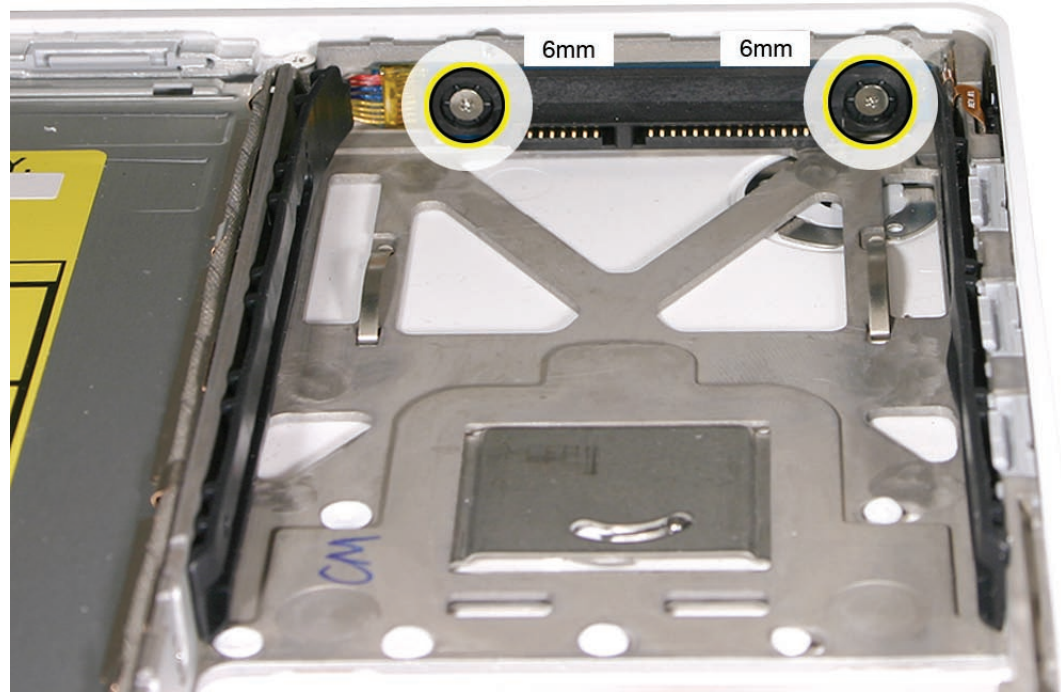

2. Carefully lift up the hard drive connector from the bottom case. This action automatically disconnects the hard drive board from the sleep LED/IR receiver flex cable.

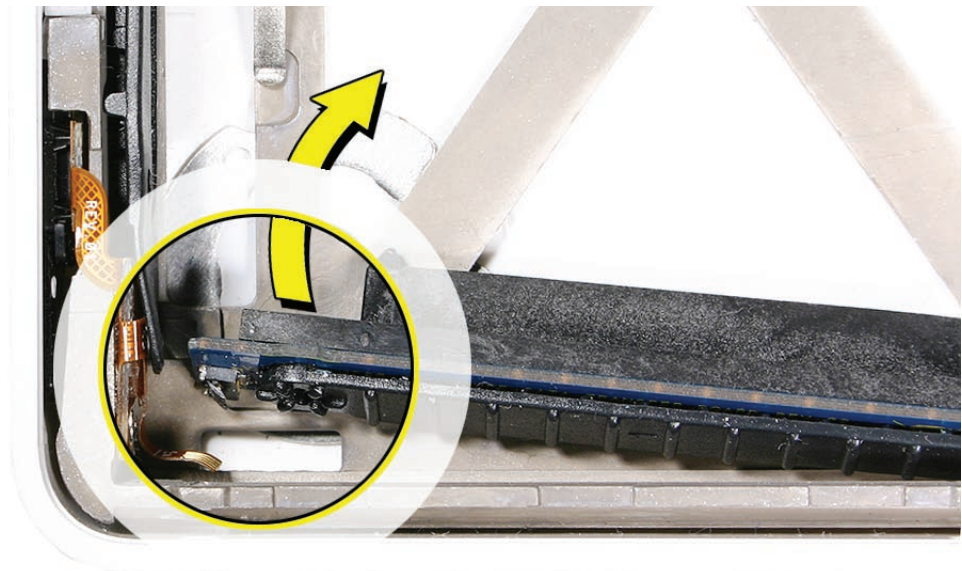

Replacement Caution: Note the tiny connector at the end of the hard drive board. It connects to the sleep LED/ IR receiver board at the front right corner of the computer via a tiny flex cable. To reinstall the flex cable, first peel up the end of the snubber to access the length of the flex cable. Carefully peel up the flex cable from its adhesive. Using a black stick, tilt up the tiny flex cable at the right corner. Insert it into the connector on the hard drive board, and fold down the tiny locking lever on the connector. Without straining the connection, carefully tilt the hard drive board into place in front of the snubber.

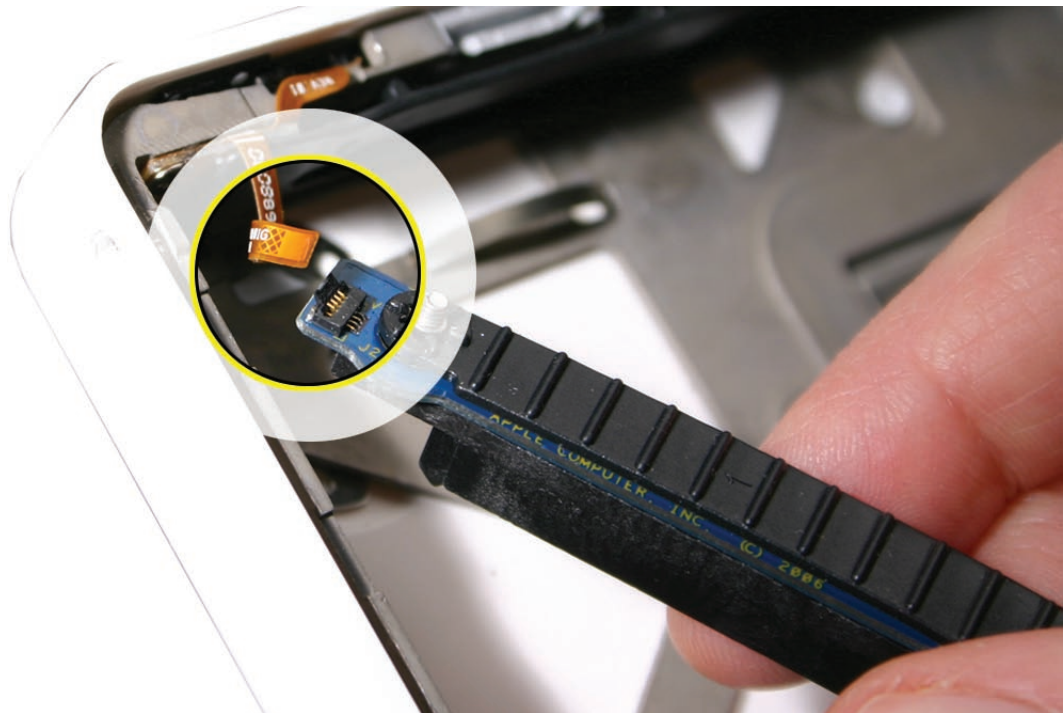
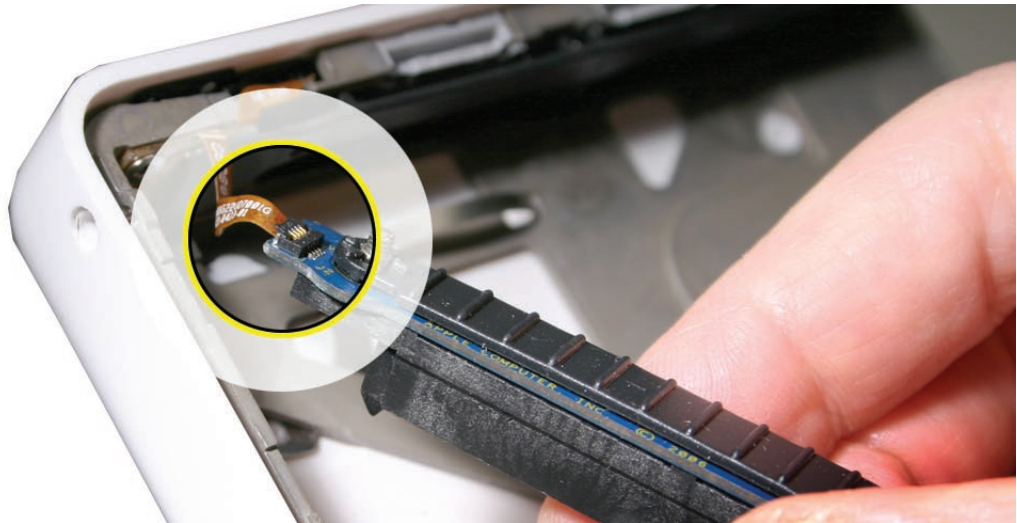

3. Pull up the hard drive connector cable that runs along the bottom edge of the optical drive. Note the three cable routing guides when reinstalling the cable.

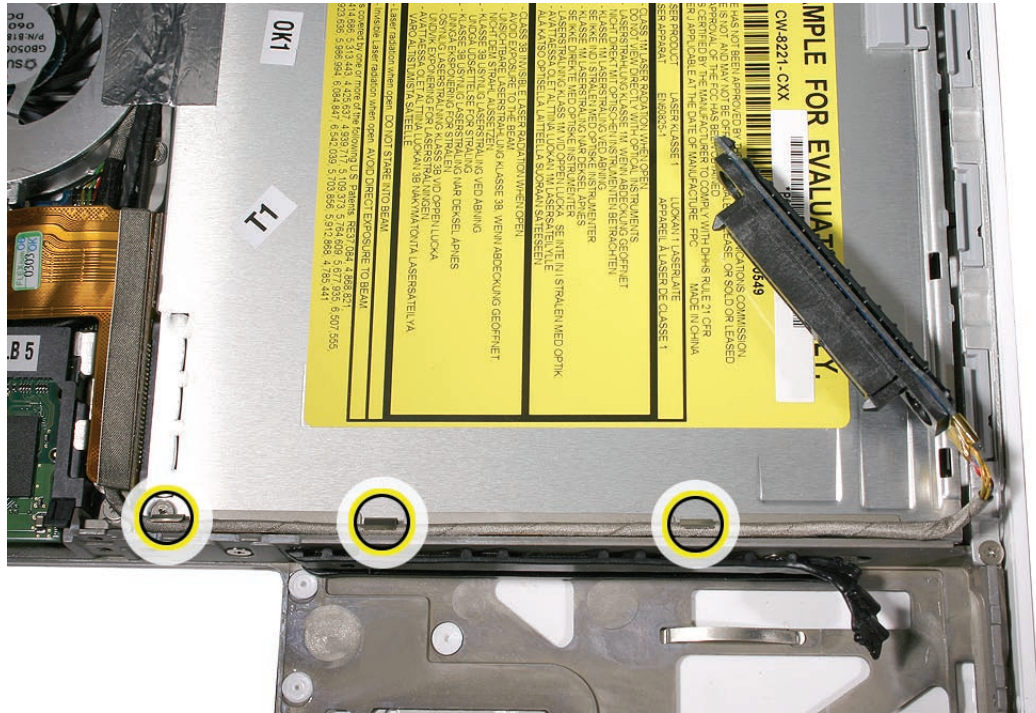

4. Use the two pull tabs to disconnect the optical drive flex cable and the LVDS cable.

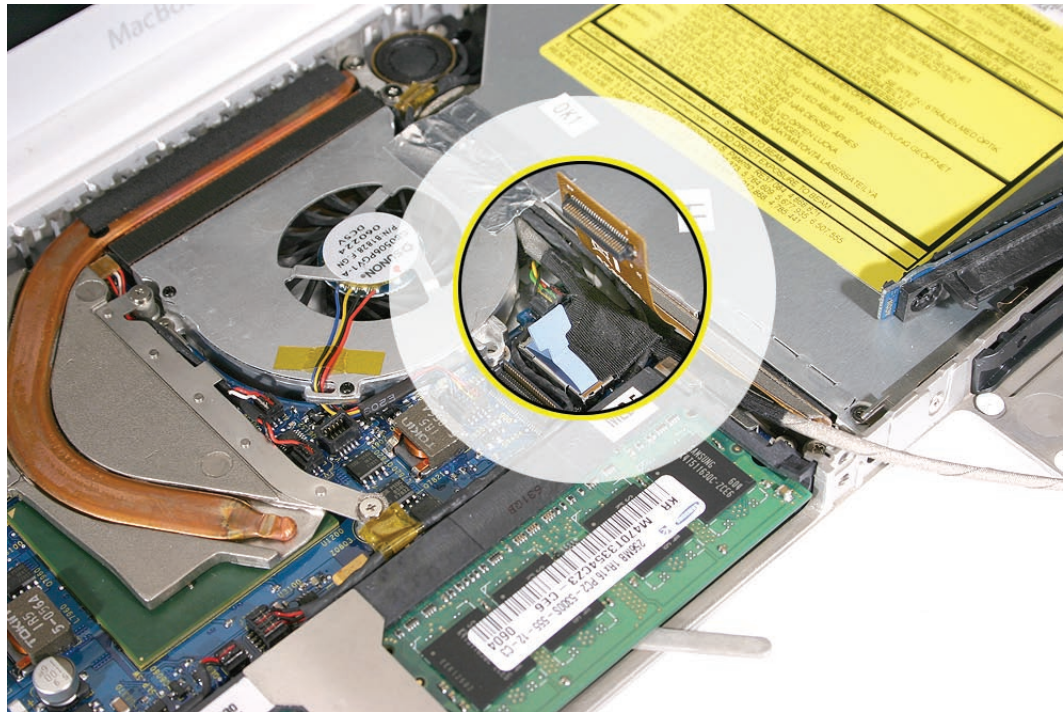

5. Use the pull tab to disconnect the hard drive connector cable.

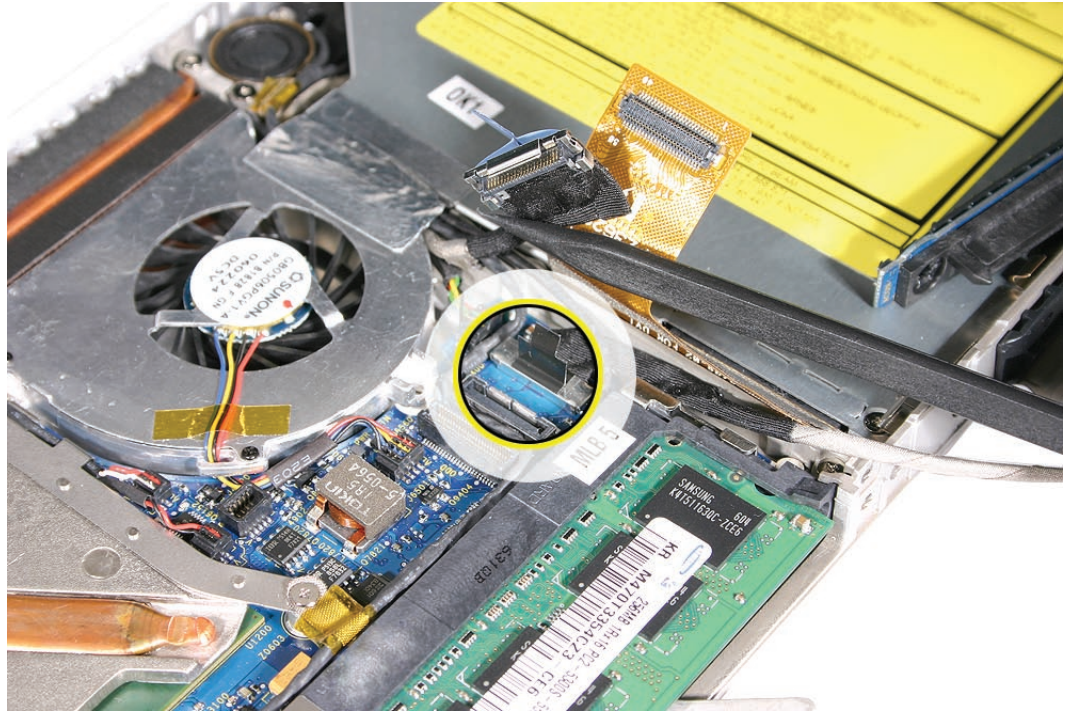

6. Route the hard drive connector cable under the black cables.

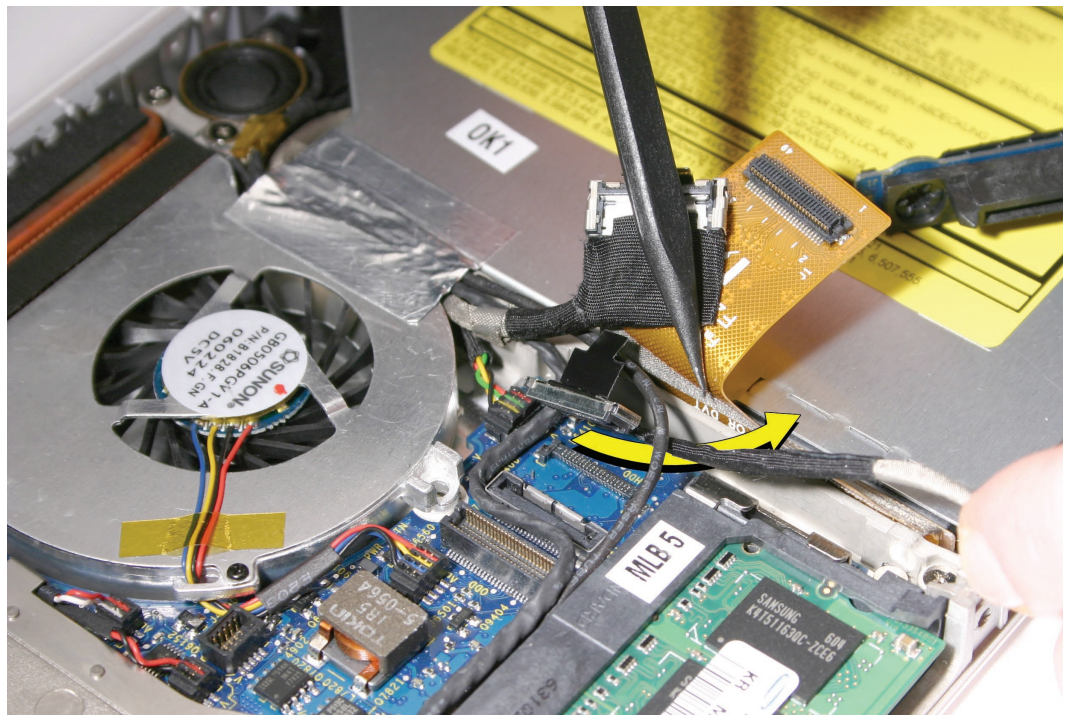

-
7. Install the replacement hard drive connector, and reassemble and test the computer.





Fan

Tools

- ESD wrist strap and mat
- Magnetic Phillips #00 screwdriver
- Black stick (Apple part number 922-5065) or other nonconductive nylon or plastic flatblade tool

Preliminary Steps

Before you begin, remove

- Battery
- RAM door
- Top case with keyboard

Part Location

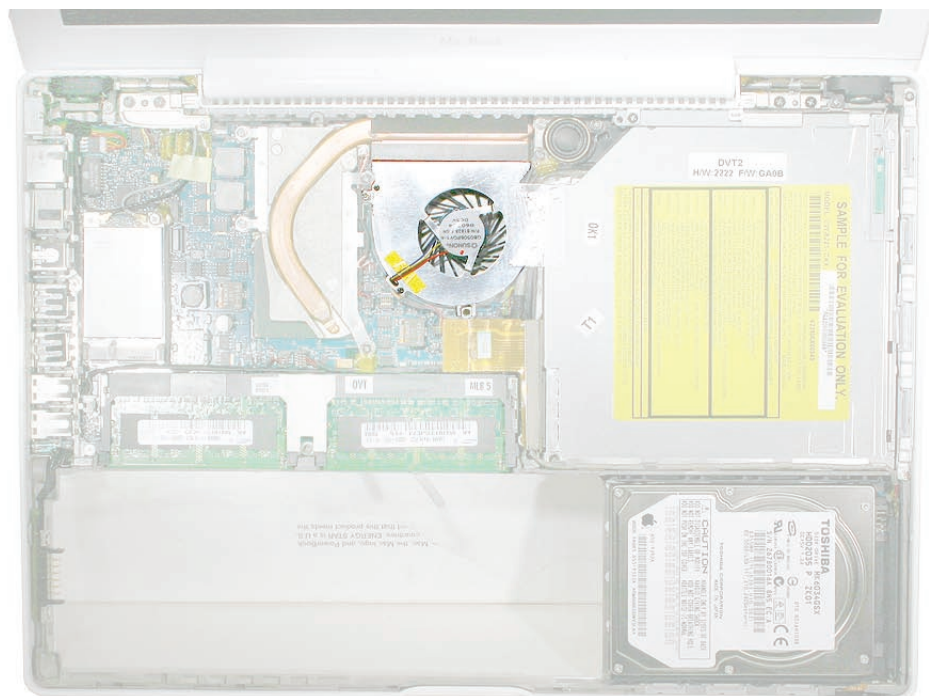

Procedure

1. Peel up the strip of tape that overlaps the fan near the optical drive.

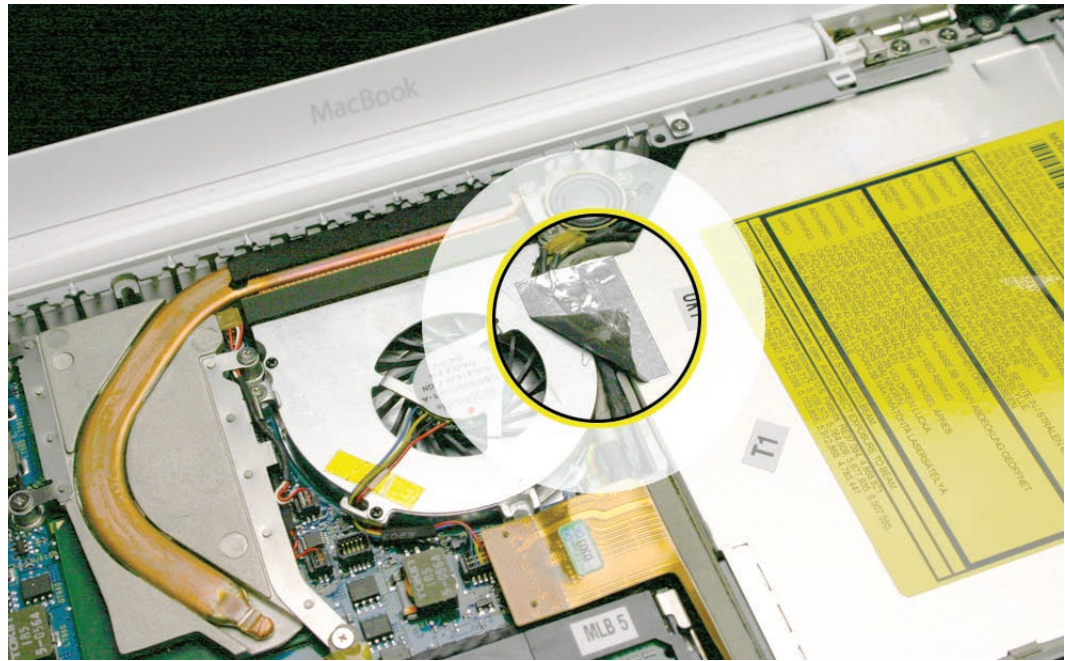

2. Remove the screws from the fan:
 - 6-mm long screw from the upper left
 - 3-mm long screw from the upper right (normally hidden underneath the cable bundles)

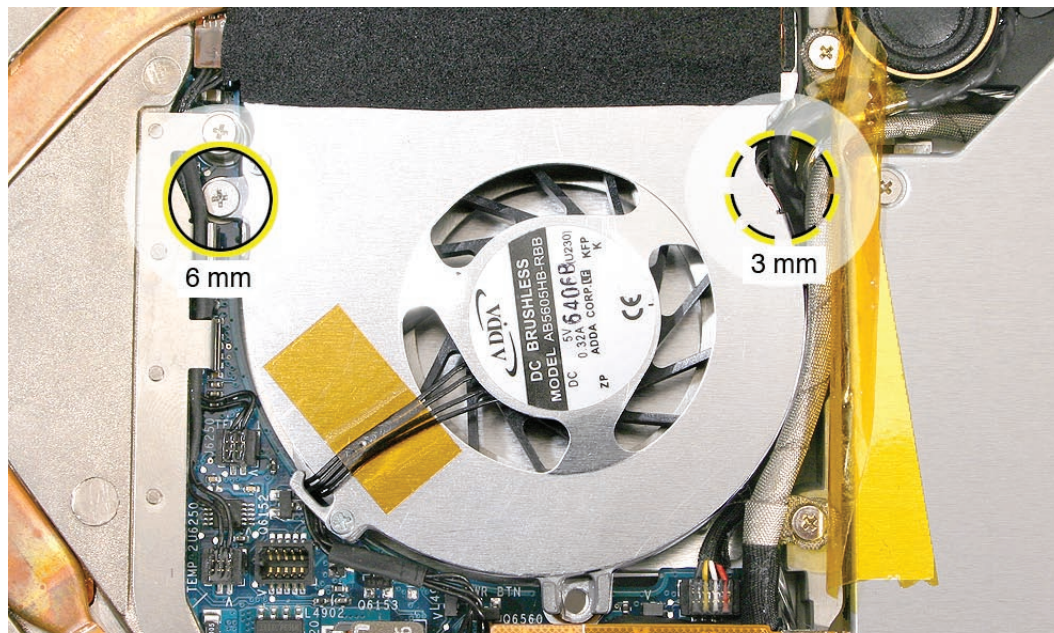

3. Tilt up the fan and disconnect the fan cable from the logic board.

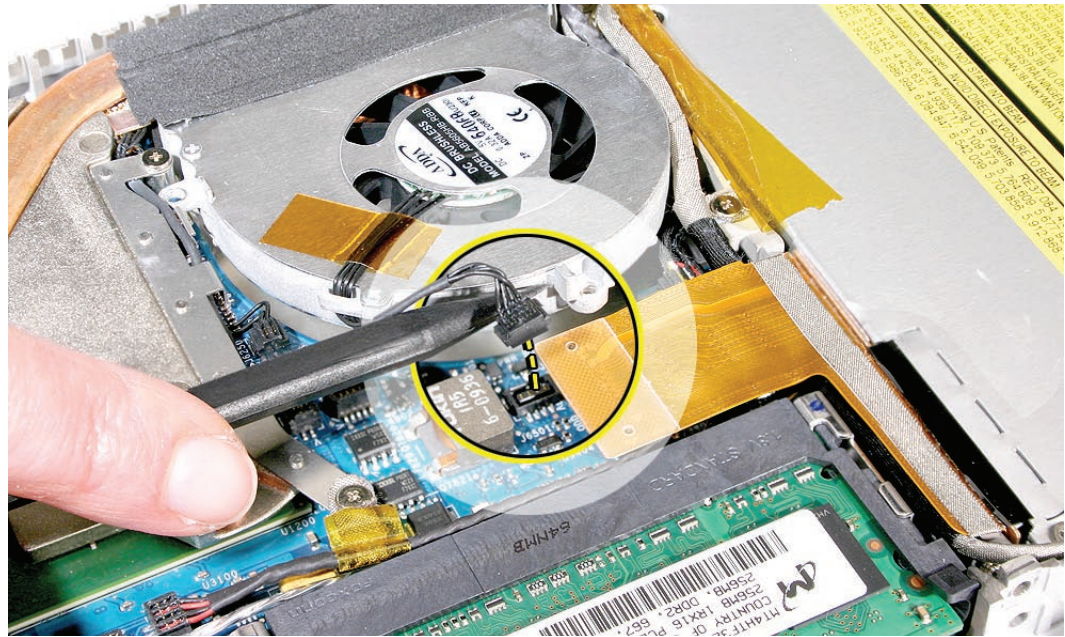

4. Holding the fan tilted up from the bottom case, peel away the adhesive foam that overlaps the fan and the heatsink.

Replacement Note: Because the foam strip tears easily, be sure to install a new strip of adhesive foam before reassembling the computer.

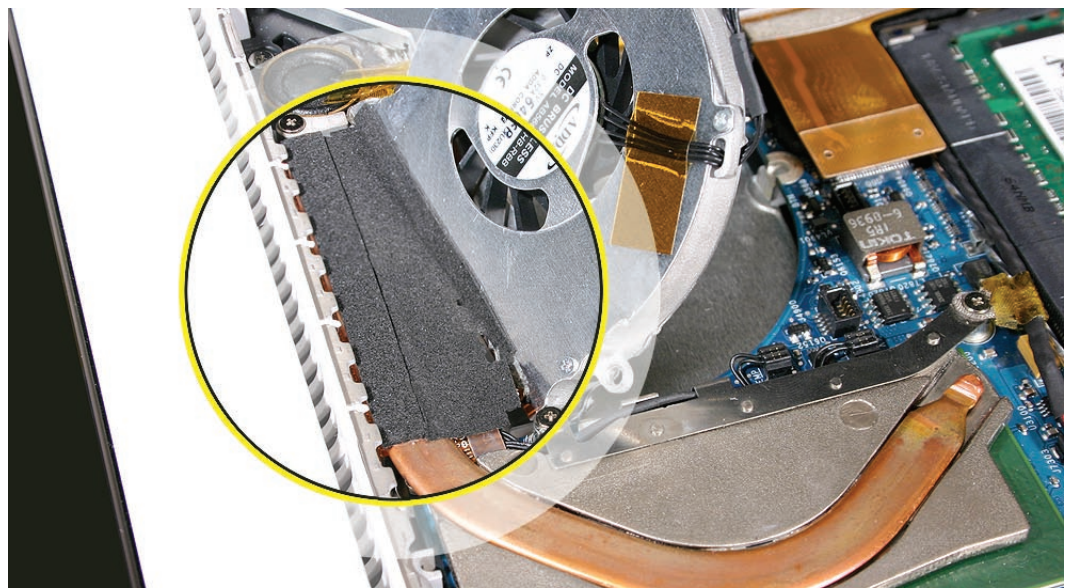

5. Install the replacement fan, and reassemble and test the computer.

Replacement Note: Make sure the cables are fully tucked in the channel between the fan and the optical drive. Reapply the tape or apply new tape.



Heatsink

Tools

- ESD wrist strap and mat
- Magnetic Phillips #0 screwdriver
- Black stick (Apple part number 922-5065) or other nonconductive nylon or plastic flatblade tool
- Alcohol wipes
- Thermal grease syringe (Apple part number 922-7144)
- Felt-tip pen (optional)

Preliminary Steps

Before you begin, remove

- Battery
- RAM door
- Top case with keyboard
- Fan

Part Location

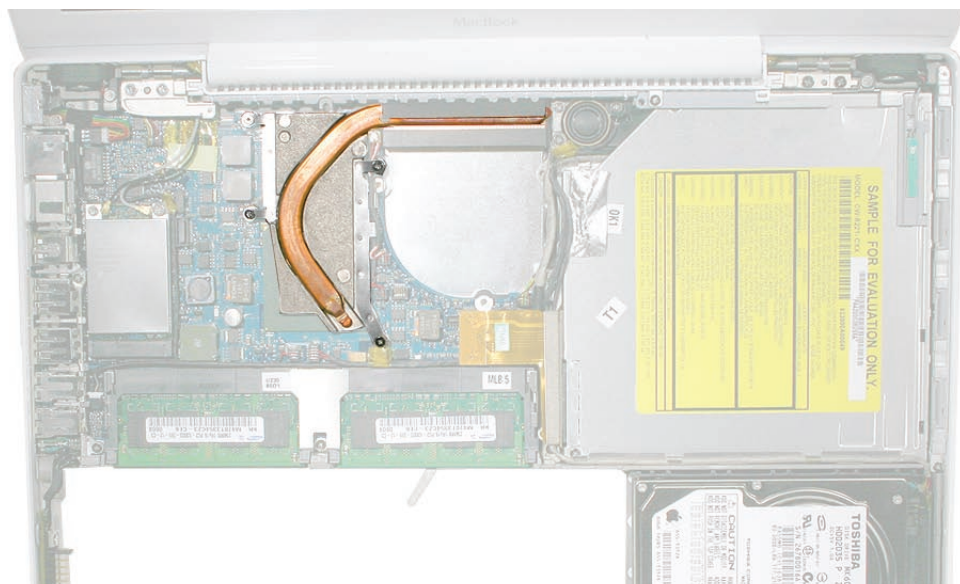

Procedure

1. Remove the four identical 8-mm long screws from the heatsink.

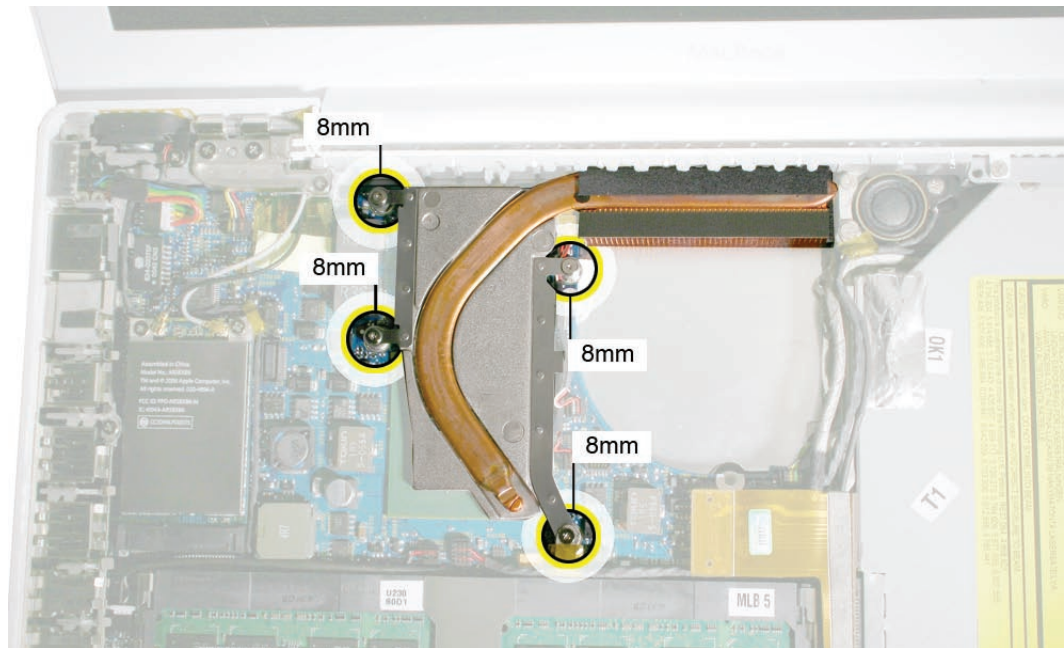

Note that the screw at the lower right corner anchors a flexible ground tab for the speaker cable that runs along the top of the RAM card carriers. Make sure the tab is sandwiched between the heatsink and the screw when it is reinstalled.

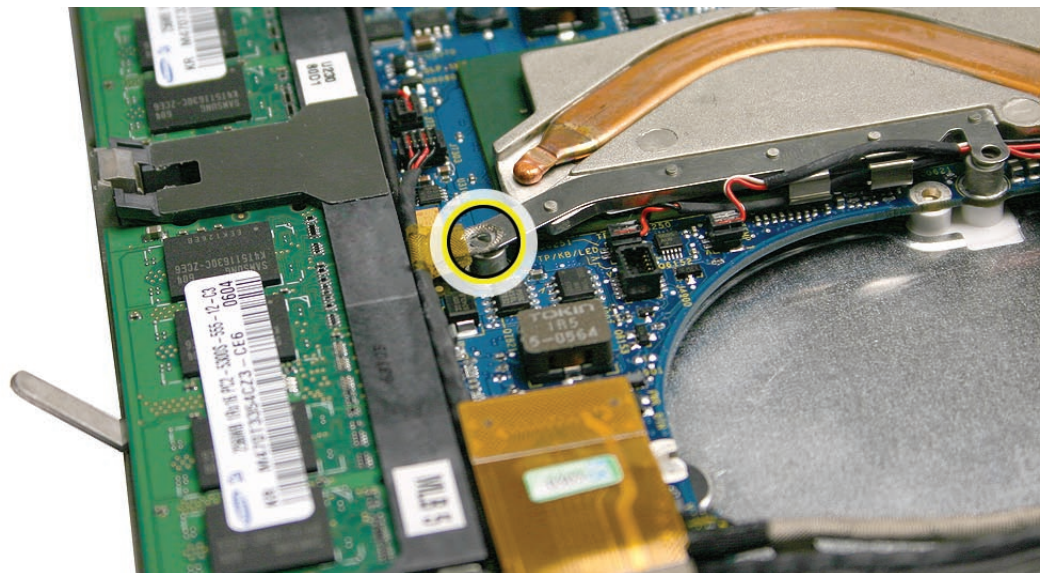

2. Starting at the lower bracket of the heatsink, start to tilt it up to loosen it from the logic board.

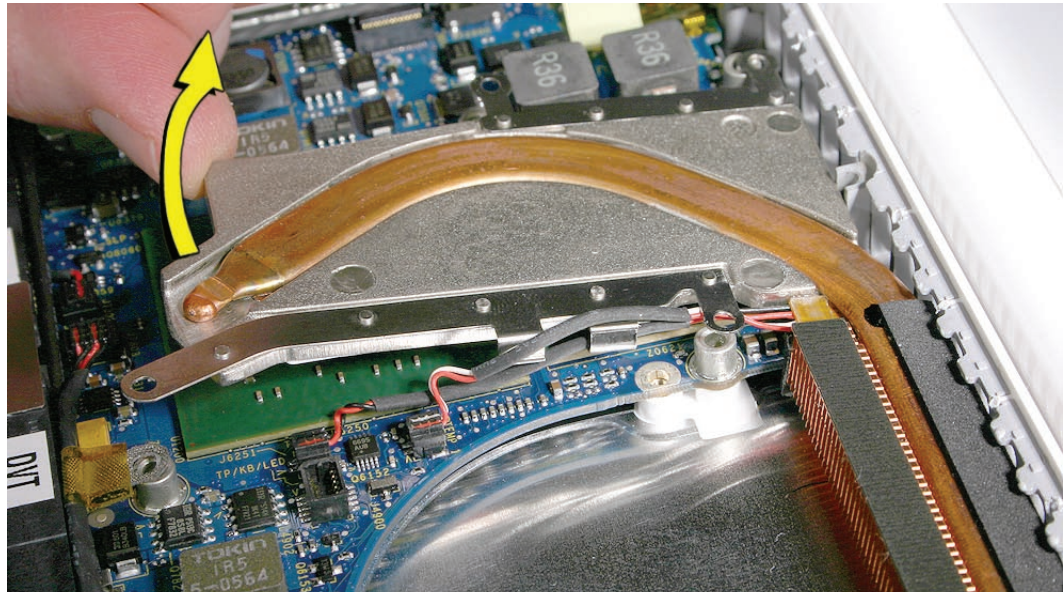

3. Holding the heatsink by its edges, tilt it up and disconnect the two thermistor connectors from the logic board.

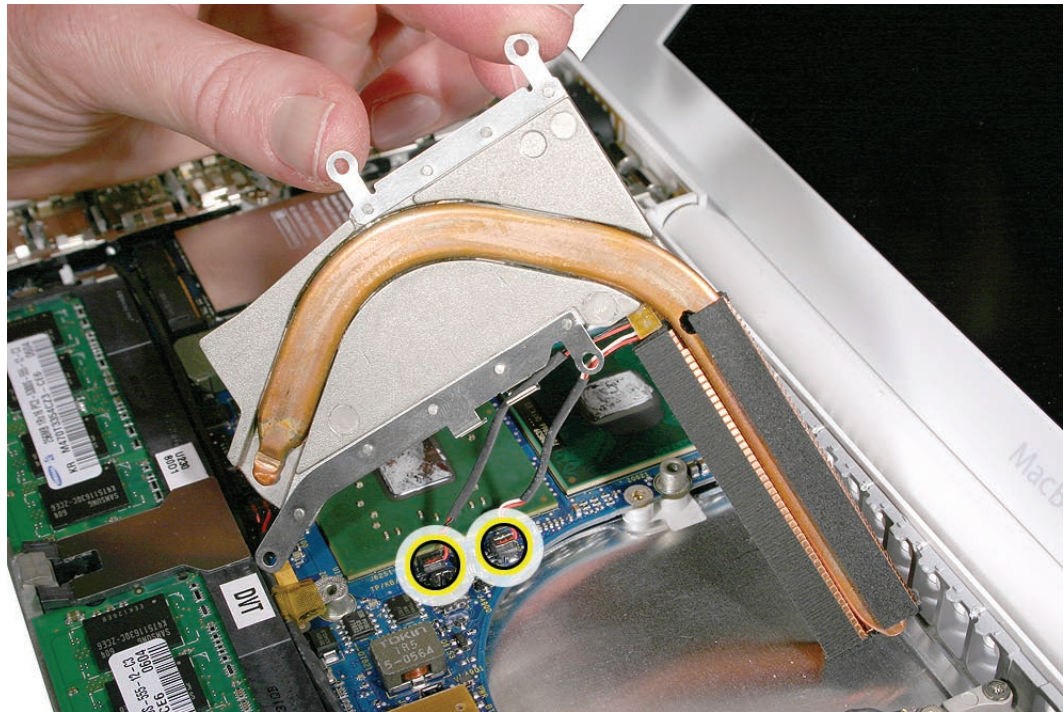

Replacement Caution: When installing the heatsink, make sure its two thermistor cables are routed as shown to prevent cable damage.

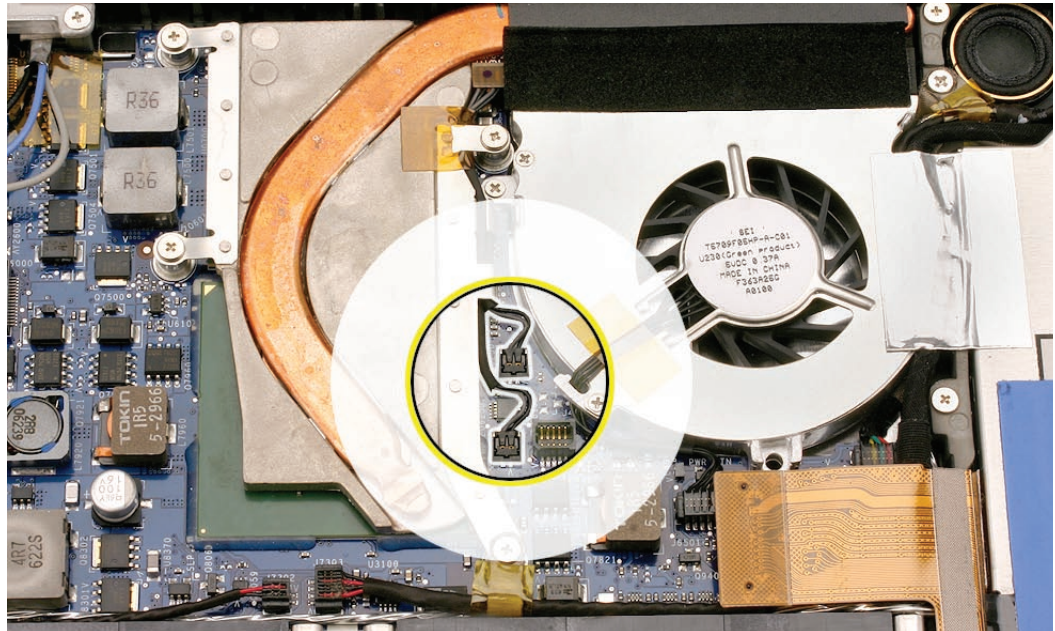

Replacement Note: Make sure you install the thermal sponge over the two thermistor connectors.

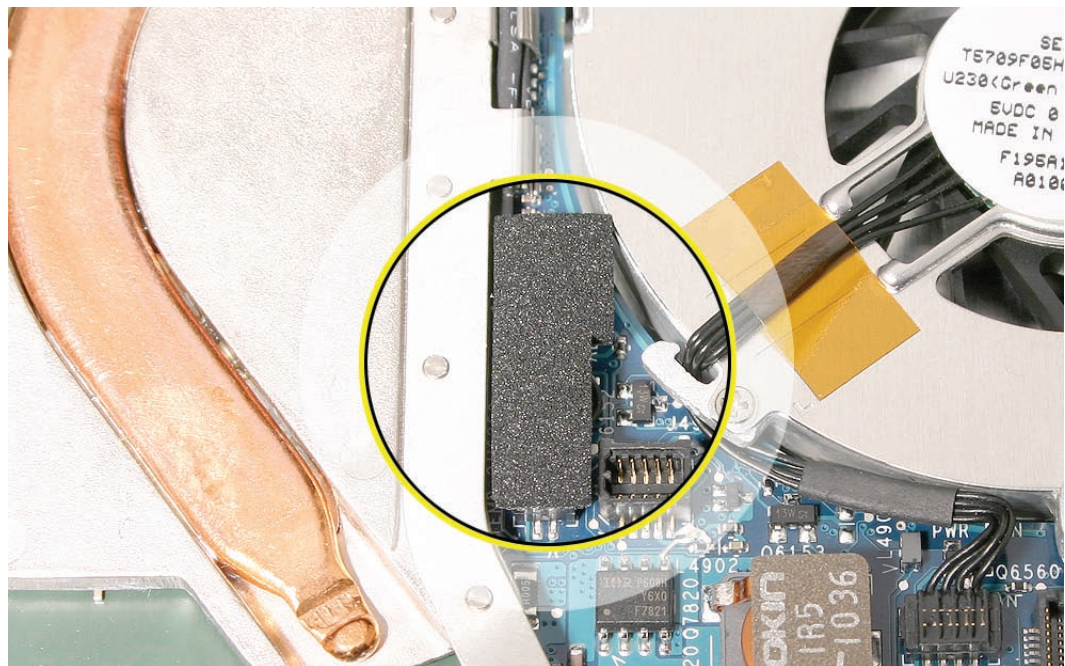

- 4. Important:** Anytime the heatsink is removed (even if it is to replace another module), check the thermal grease as described in the following section.

Checking the Thermal Grease

Warning: Whenever the heatsink is separated from the logic board (even if you are installing the same heatsink or board), the thermal grease must be checked and possibly replaced. Failure to do so can cause the computer to overheat and be damaged.

1. With the heatsink removed, check the underside of the heatsink:
 - If it has a thin sheet of transparent film covering the square heatsink pads and pre-applied thermal grease, then you do not need to reapply thermal grease. Do not remove the thin film. Skip step 2 and go to step 3 to clean up any excess thermal grease that might have squeezed out onto the chips. Then go directly to step 8.

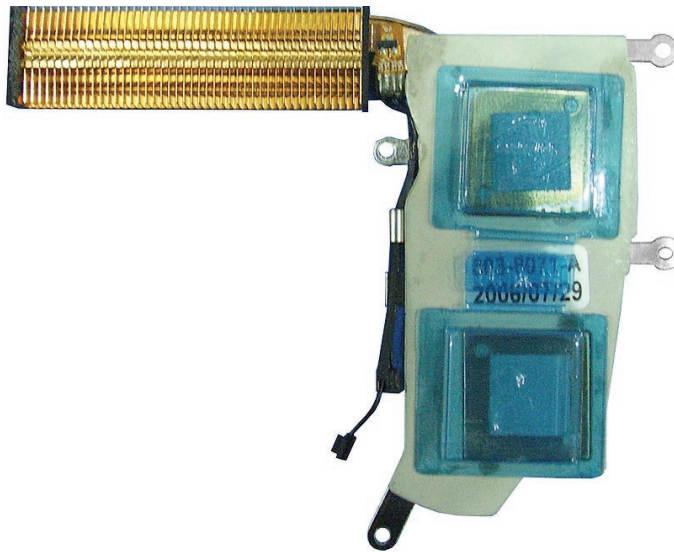

- If you are installing a new heatsink and it is packaged with clear, rigid plastic, remove the clear plastic from the heatsink plate. Because the heatsink includes pre-applied thermal grease, skip step 2 and go to step 3. Then go directly to step 8.

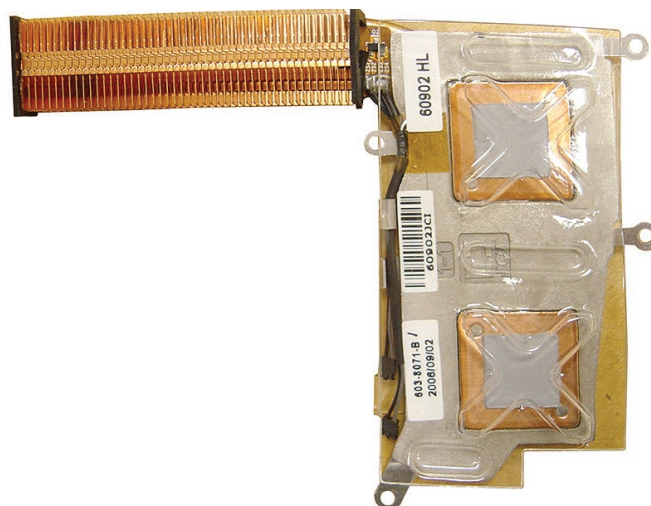

- If the thermal grease is directly on the heatsink pads (as shown in step 2), continue with the remaining steps in this procedure.

2. **Caution: This step is required only when the heatsink and logic board are removed to replace a later part (such as the bottom case) and the same heatsink and logic board will be re-installed in the computer.**

Use a black stick to remove as much thermal grease as possible from the two chips on the logic board and the two pads on the heatsink.

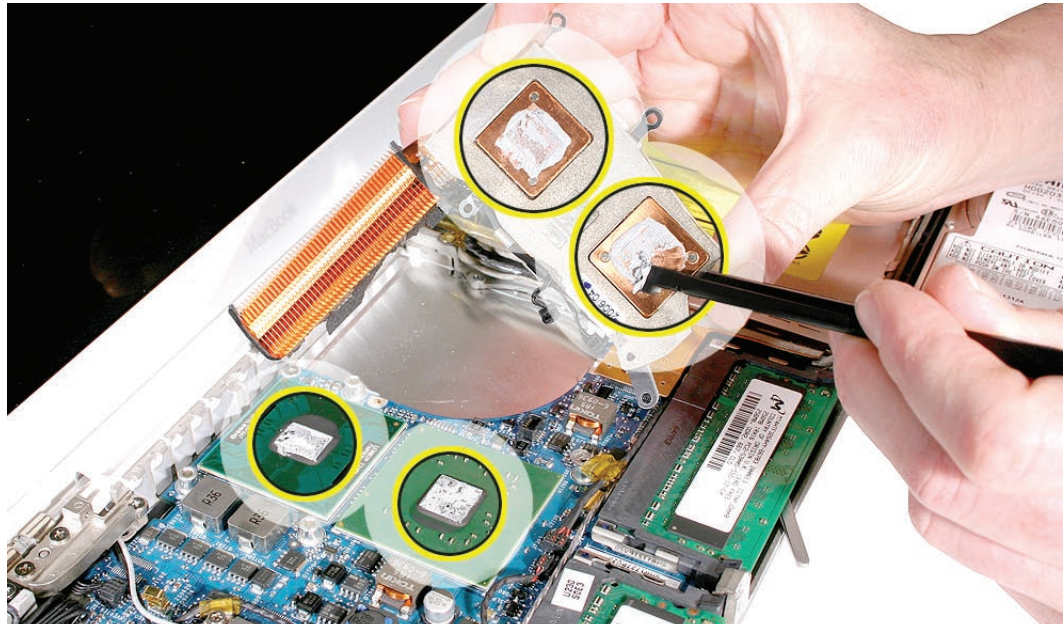

3. Use an alcohol wipe to completely clean the residual thermal grease from the two chips. (If you are replacing the logic board with a new one, skip this step.)

Important: Use extreme care not to damage the logic board components.

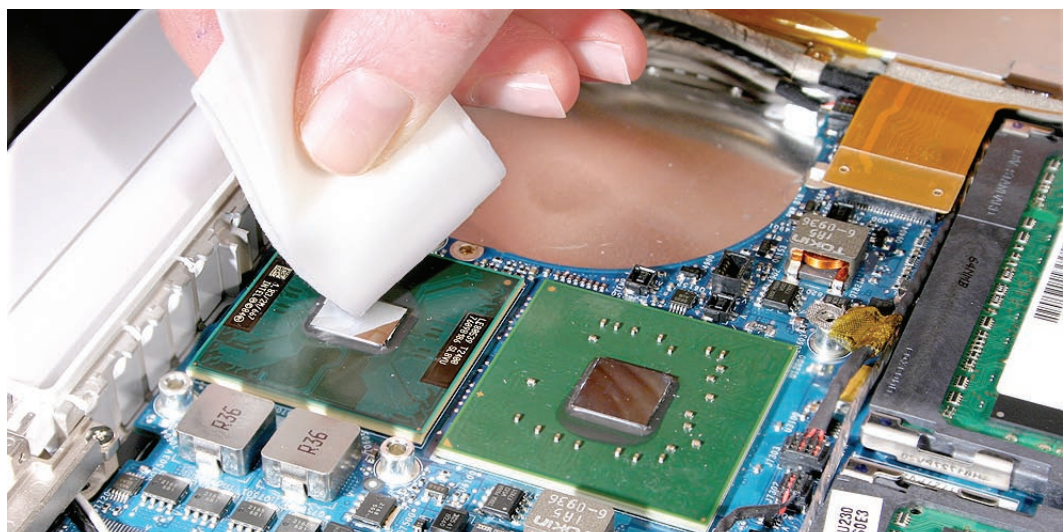

4. Use an alcohol wipe to completely clean the two pads on the heatsink.

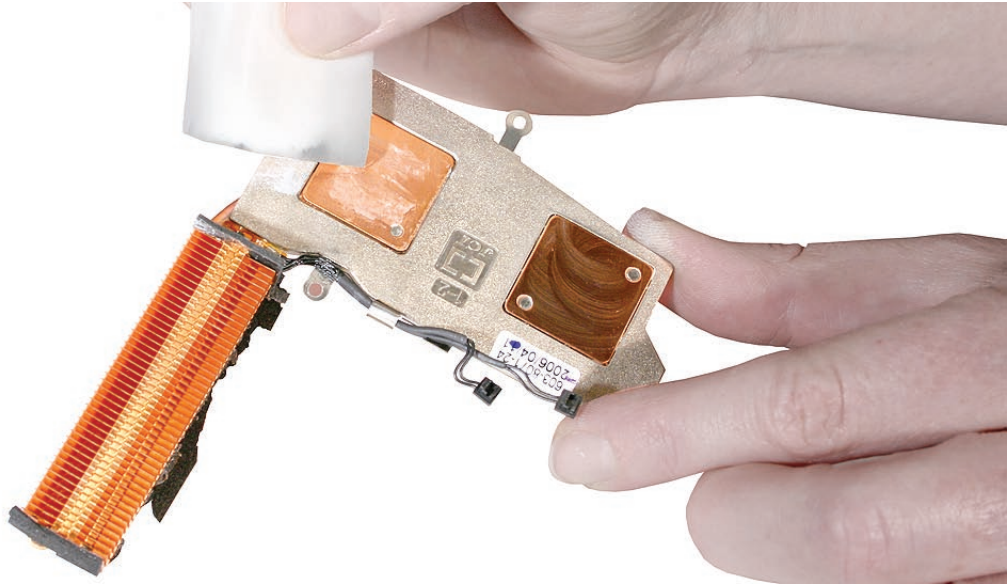

5. **Caution:** The syringe steps for this procedure are required only when the heatsink and logic board are removed to replace a later part (such as the bottom case) and when no new heatsink with pre-applied thermal grease will be installed. Refer to the heatsink conditions in step 1 for details before attempting to replace the thermal grease.

Note the contents of the syringe of thermal grease.

Important: One syringe (922-7144) contains 0.3 to 0.35 cubic centimeters (cc) of thermal grease. That is enough for 0.1 to 0.12 cc of grease per chip for up to three chips. Because this computer has only two chips, the last 1/3 of thermal grease remains in the syringe. Use one-third of the syringe contents per chip. Using a felt-tip pen, mark the 1/3 points on the syringe before applying the first dab.



- Using the syringe, put a 0.1 to 0.12 cc dab of thermal grease, in the center, on the mating surfaces of both chips, as shown below. Apply the grease only up to the line that you marked on the syringe.

Important: Use one-third of the syringe contents per chip, so in this case, 1/3 of the thermal grease will be left in the syringe when you are done. Although the amount shown appears to be plenty of grease, this is the correct amount that has been tested and verified on the production line.

Important: Avoid unnecessary contact with new thermal material, as dirt and body oils reduce the material's conductivity.

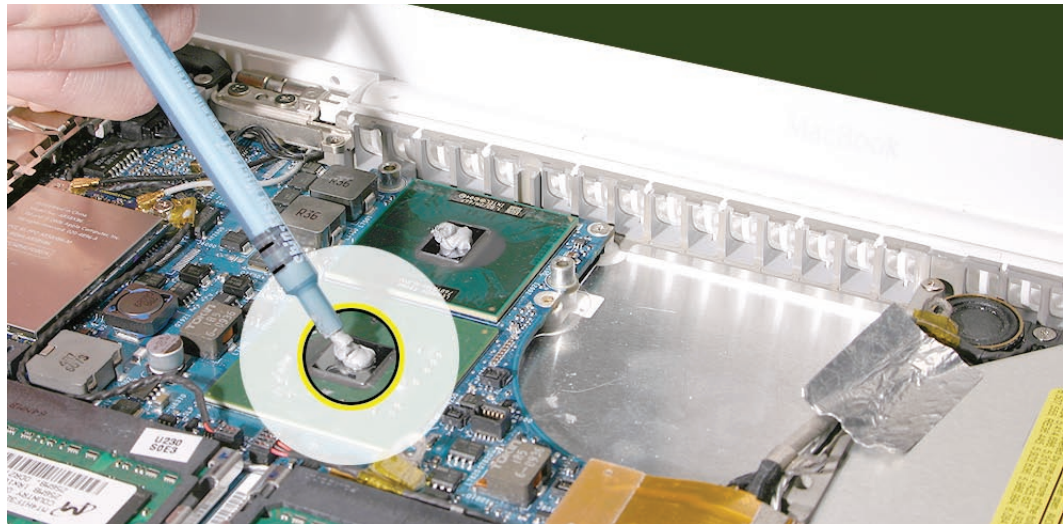
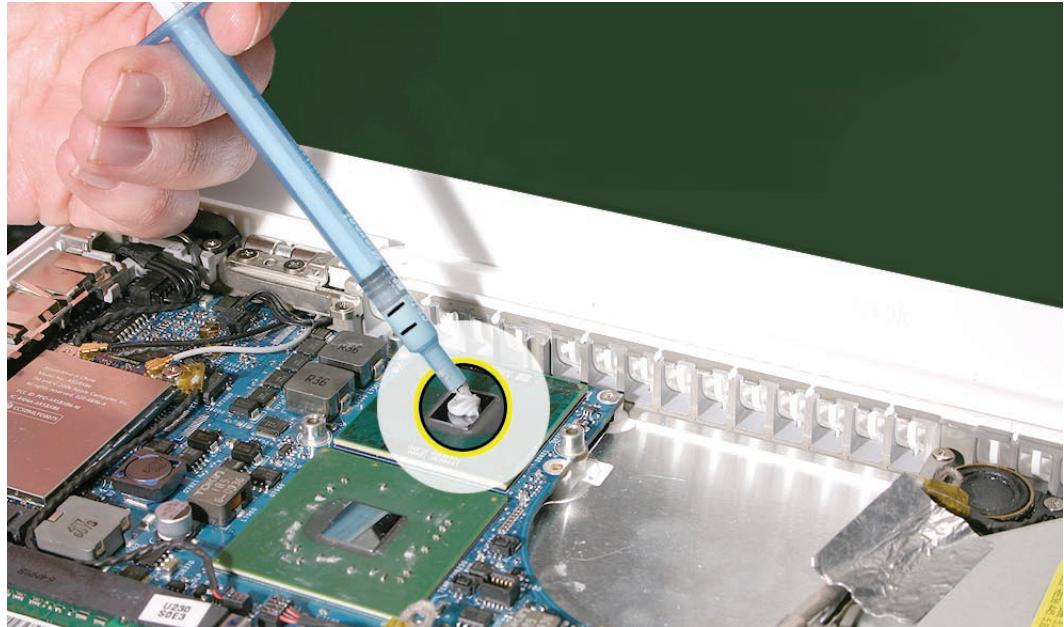

7. While centering the heatsink pads over the two chips, lower the heatsink onto the logic board and press on the areas where the screw brackets on the heatsink meet the standoffs on the board. Make sure the heatsink is level on the board before installing the screws.

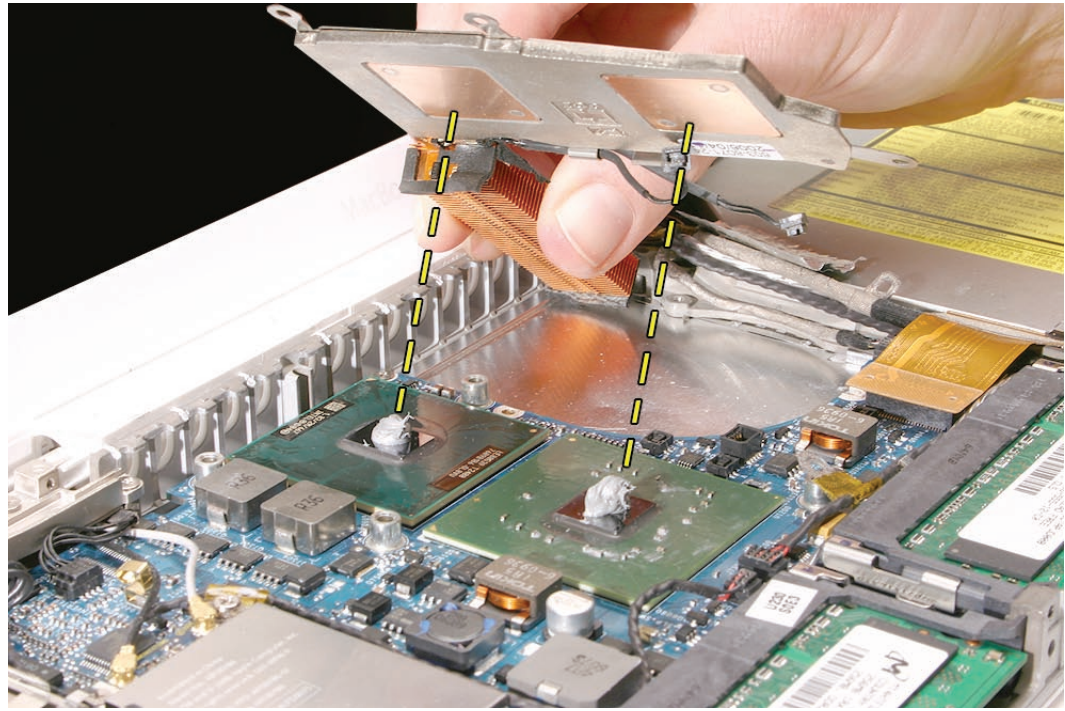

8. Install the heatsink (using the screw sequence shown below), and reassemble and test the computer.
Note: Make sure the heatsink includes the gray, adhesive sponge strip that sticks to and runs along the top of the copper pipe. (A new heatsink kit includes the gray strip, ready for installation.)

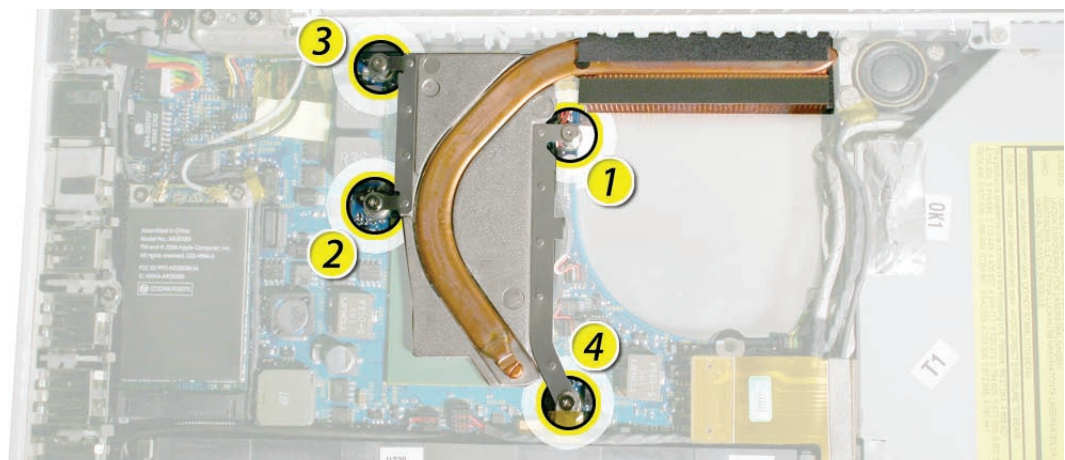

9. **Replacement Note:** If you replaced the heatsink from a kit that includes the thermal sponge, install the thermal sponge over the two thermistor connectors.
- Make sure the connectors are fully seated.
 - Remove the adhesive backing from the sponge, and place the sponge **adhesive side down** over the two connectors.
 - Make sure the sponge sticks to and completely covers both connectors. (The actual color and appearance of the sponge may vary slightly from what is included in the kit.)

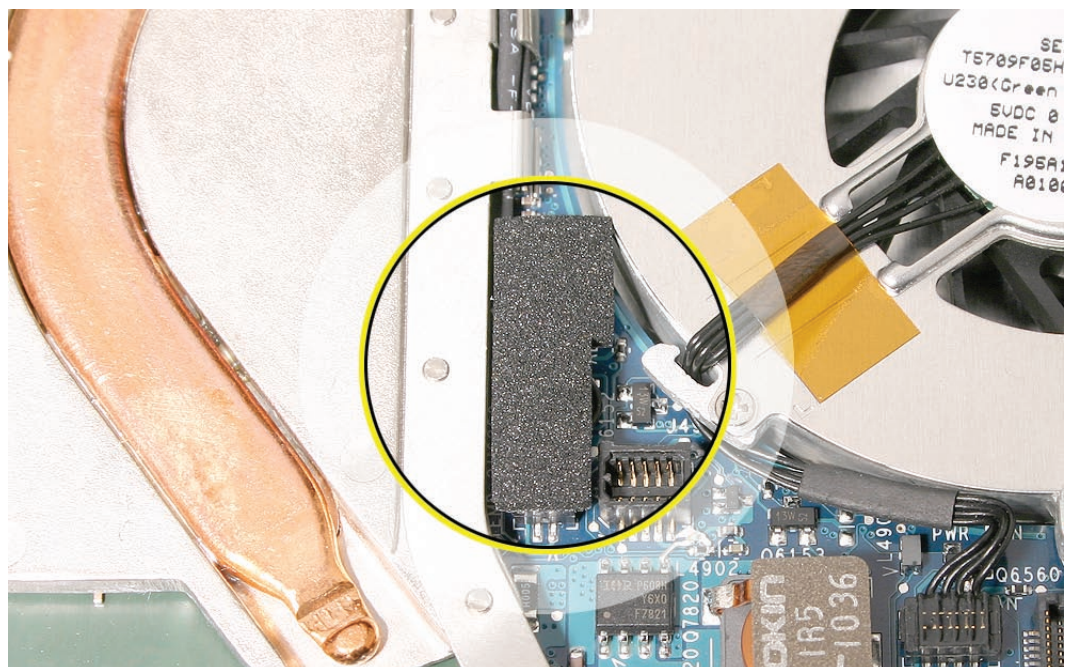
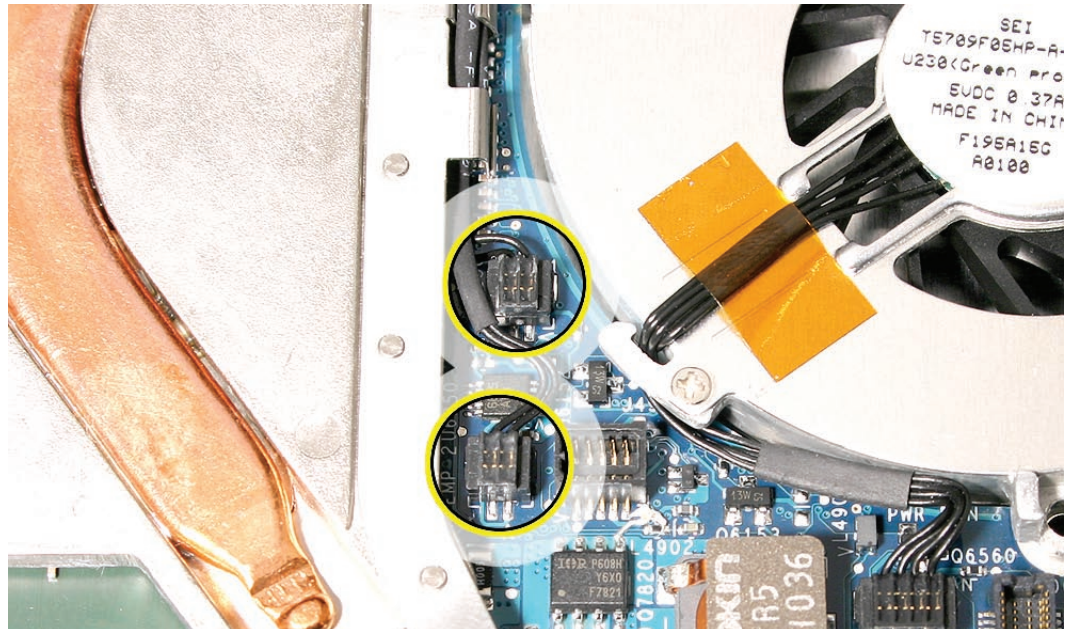

Comparing Heatsinks

The heatsink referred to as a 1.2 mm heatsink can be identified by the number 607-0142 on its label and its thin rectangular thermistor connectors. Order Apple part number 076-1242 (which includes the heatsink, thermal tape, and sponge) to replace a 1.2 mm heatsink.

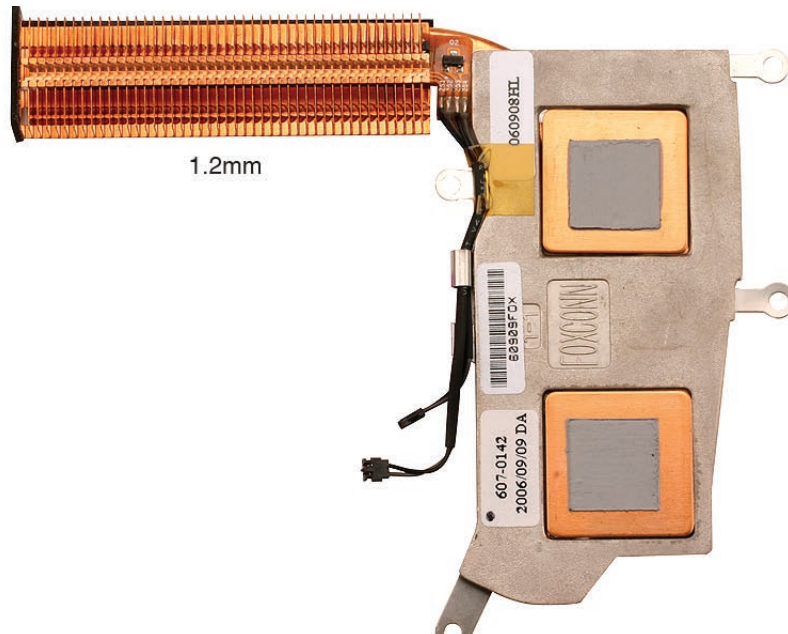

The heatsink referred to as a 1.0 mm heatsink can be identified by the number 607-0199 on its label and its thick square thermistor connectors. Order Apple part number 076-1243 (which includes the heatsink, thermal tape, and sponge) to replace a 1.0 mm heatsink.

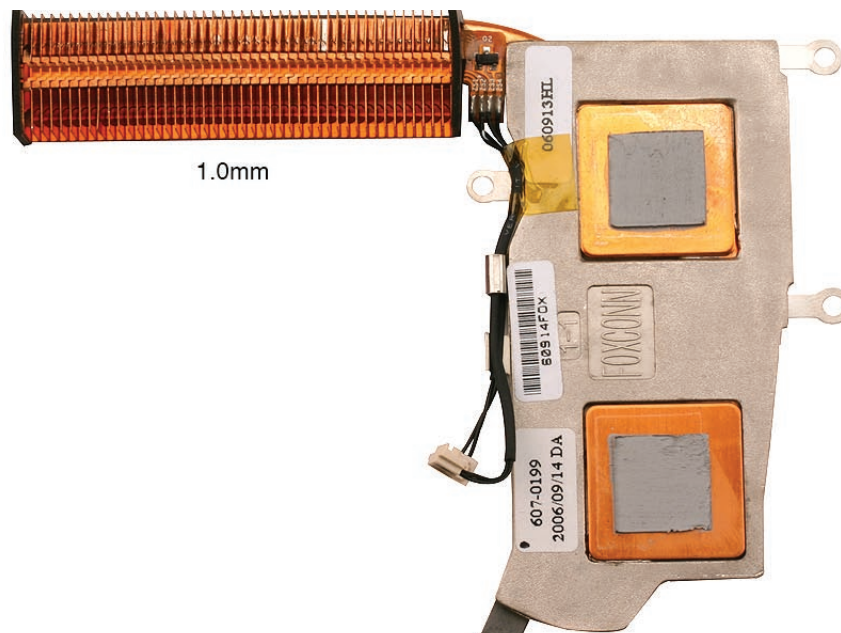



Bluetooth Holder

Important: The Bluetooth holder is included with a replacement optical drive and should not be removed unless it is damaged or no longer sticks to the optical drive housing.

Tools

- ESD wrist strap and mat
- Any standard size CD or DVD disc
- Black stick (Apple part number 922-5065) or other nonconductive nylon or plastic flatblade tool

Preliminary Steps

Before you begin, remove

- Battery
- RAM door
- Top case with keyboard

Part Location

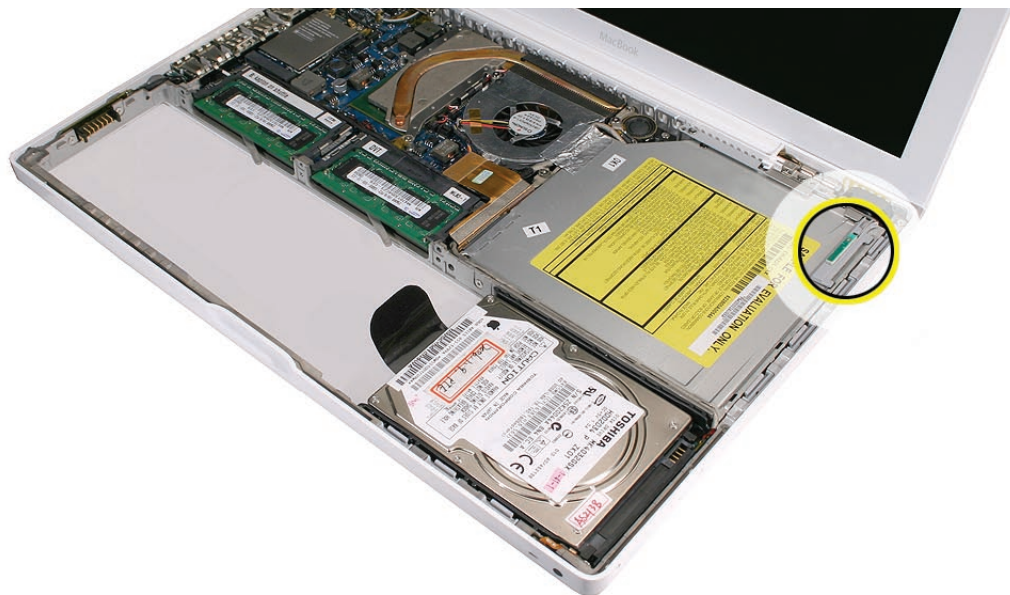

Procedure

1. Insert a CD or DVD disc half way into the slot drive to help support the drive and prevent damage.



2. Use a black stick to slide out the Bluetooth board from its holder.



3. **Warning:** To prevent damage to the optical drive, do not touch or press anywhere else on the drive.
4. Use a black stick to carefully pry up the Bluetooth holder from the top of the optical drive. Make sure you use as little pressure as possible to prevent damage to the drive.



Replacement Note: Peel off the adhesive backing from the Bluetooth holder and apply it to the drive where shown. Press the holder lightly to make sure it adheres to the drive.



-
5. Install the replacement Bluetooth holder, remove the optical drive disc, and reassemble and test the computer.





Optical Drive

Tools

- ESD wrist strap and mat
- Magnetic Phillips #0 screwdriver
- Black stick (Apple part number 922-5065) or other nonconductive nylon or plastic flatblade tool

Preliminary Steps

Before you begin, remove

- Battery
- RAM door
- Top case with keyboard

Part Location

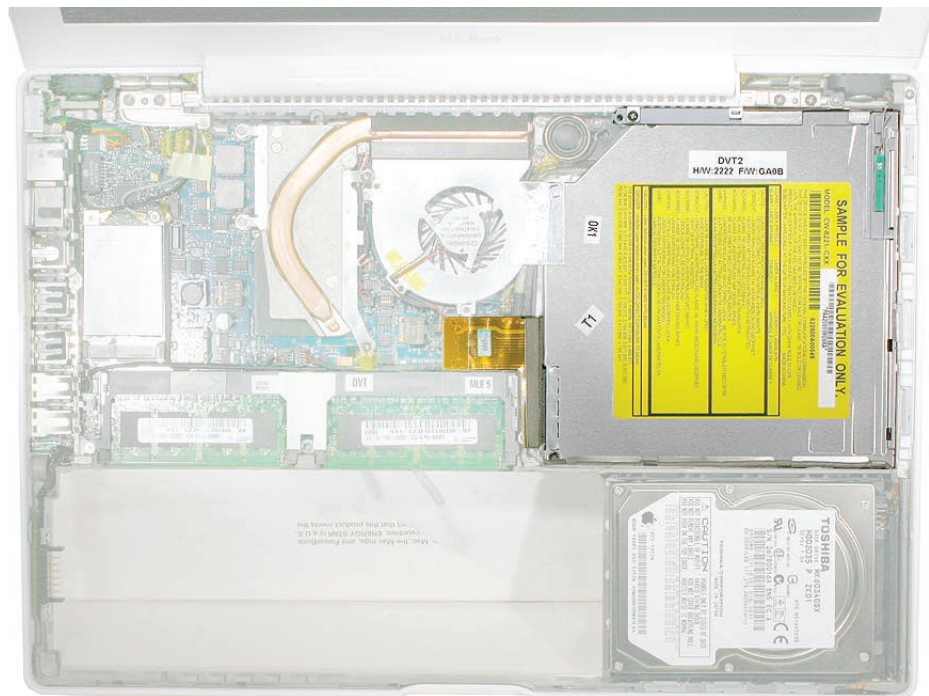

Procedure

1. With the computer assembly on a clean, scratch-proof surface, locate the Bluetooth board and holder. Note that the Bluetooth holder stays with the drive and is included with a replacement optical drive.

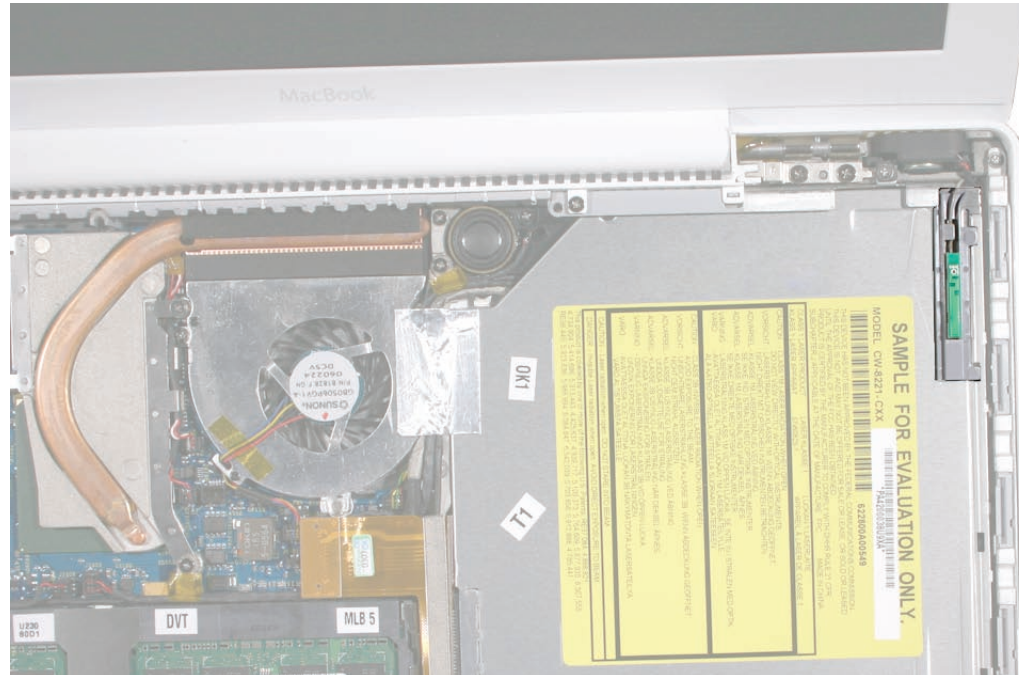

Late 2006 Model:

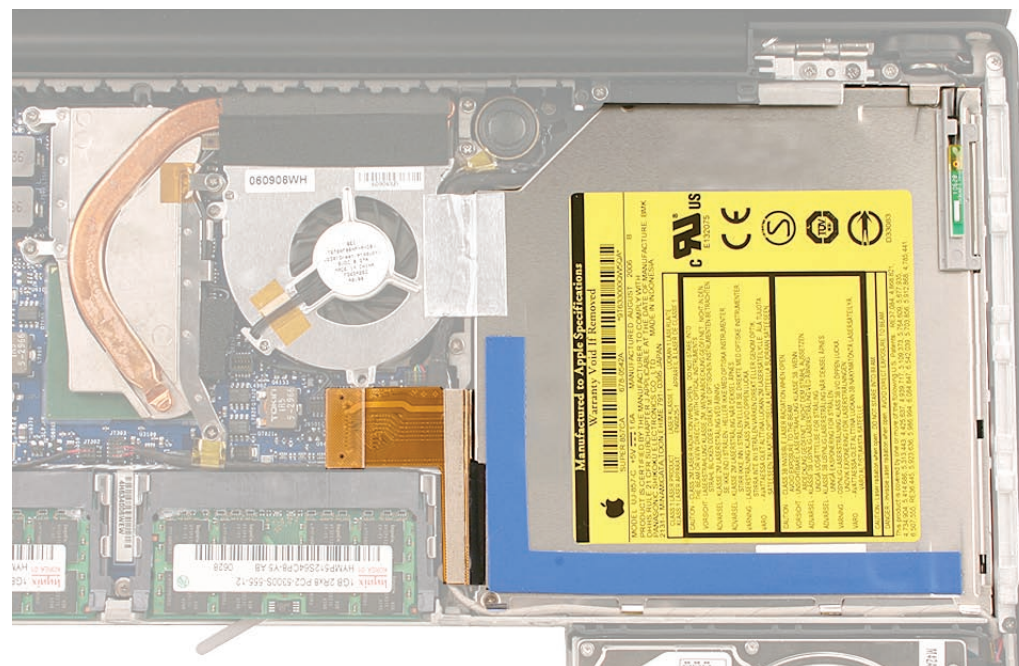

2. Tilt up the Bluetooth board from the upper right corner of the optical drive.

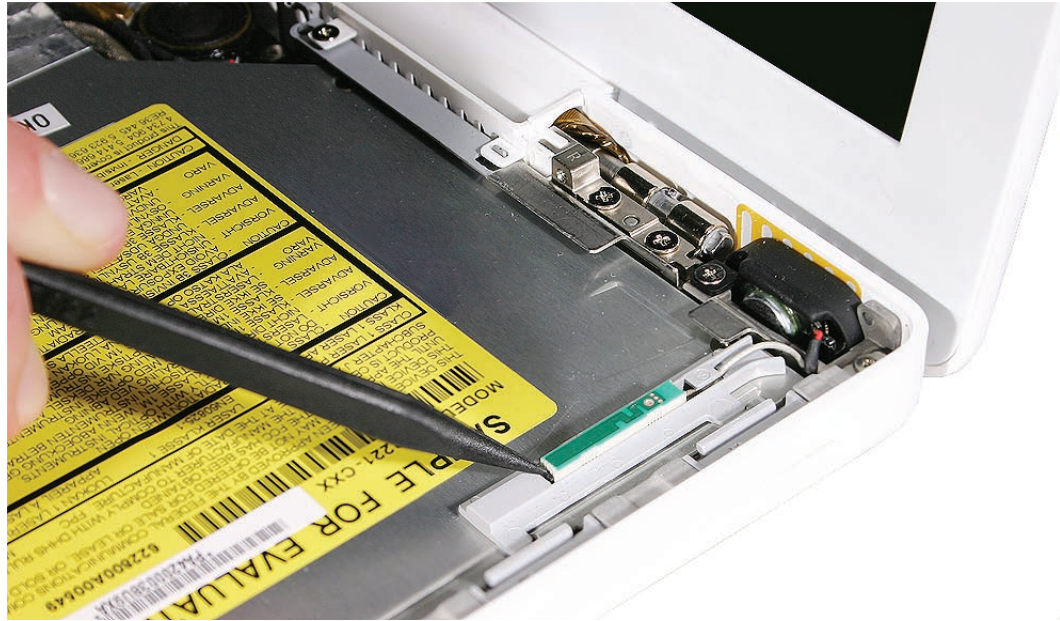

3. Disconnect the optical drive flex cable from the logic board.

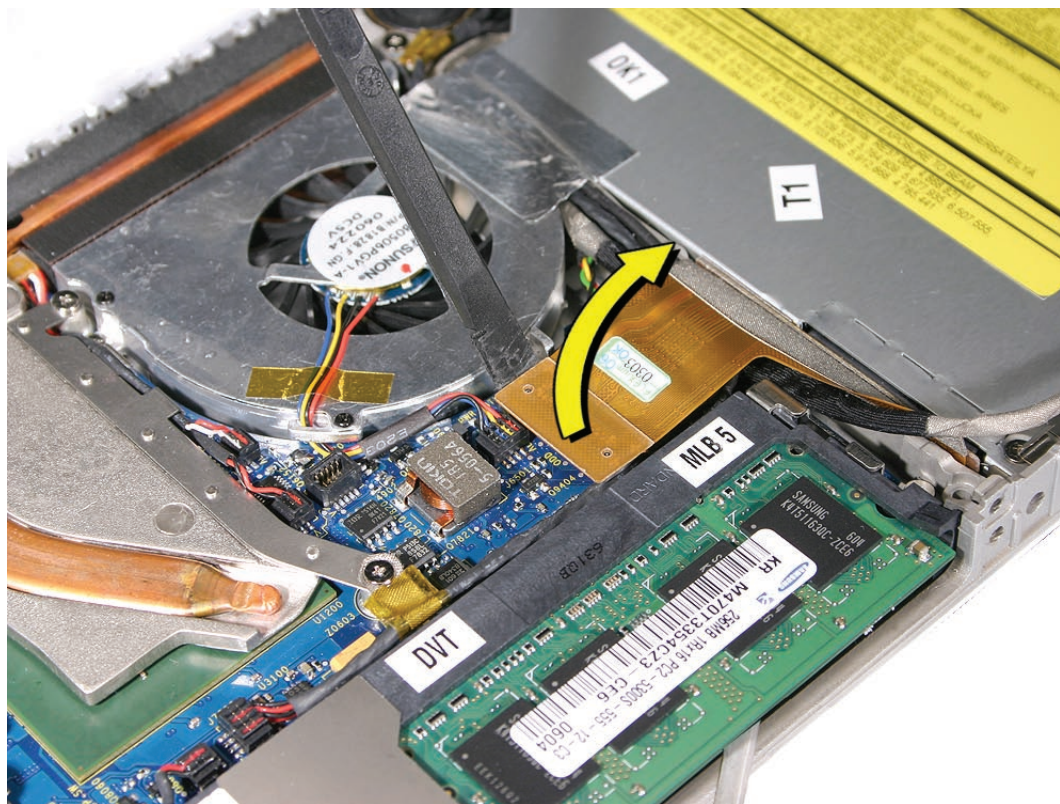

4. Peel up the tape from the optical drive.



5. Carefully lift up or move aside the cables without to remove the single 5.5-mm long screw at the mounting bracket. You might need to disconnect the ground screw by the speaker to loosen the cables and access the mounting bracket screw.

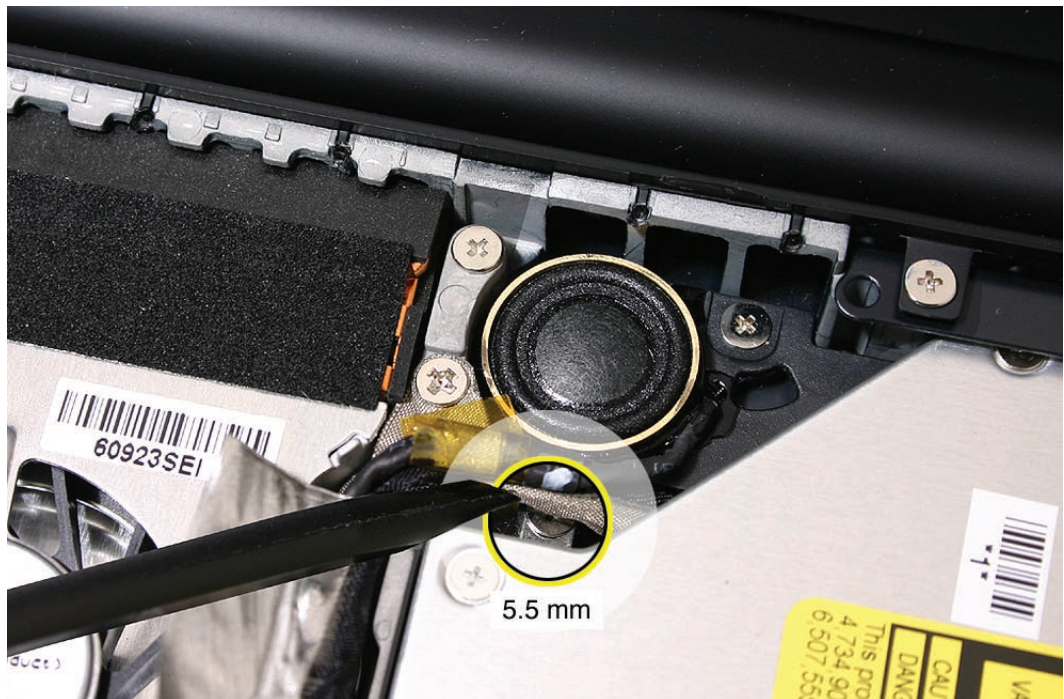

6. Use a black stick to slide the mounting bracket forward (away from the body of the drive and toward the fan) to disengage it.

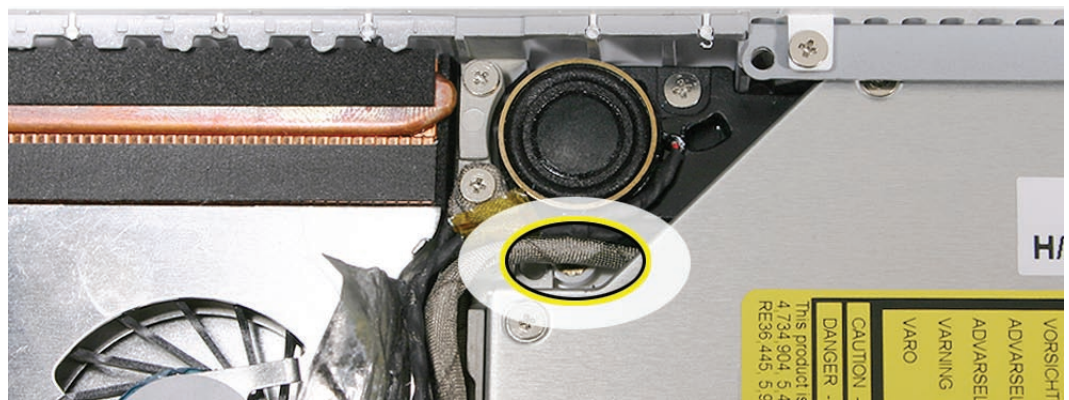
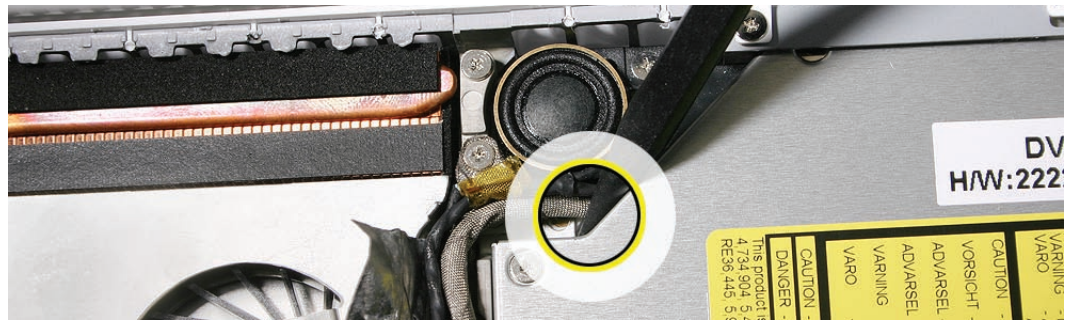

7. Slide out the hard drive, and set it aside.



8. Access the two identical 3-mm long screws along the bottom edge of the drive at the hard drive snubber. (If the snubber is blocking one of the screws, carefully peel up the snubber.)

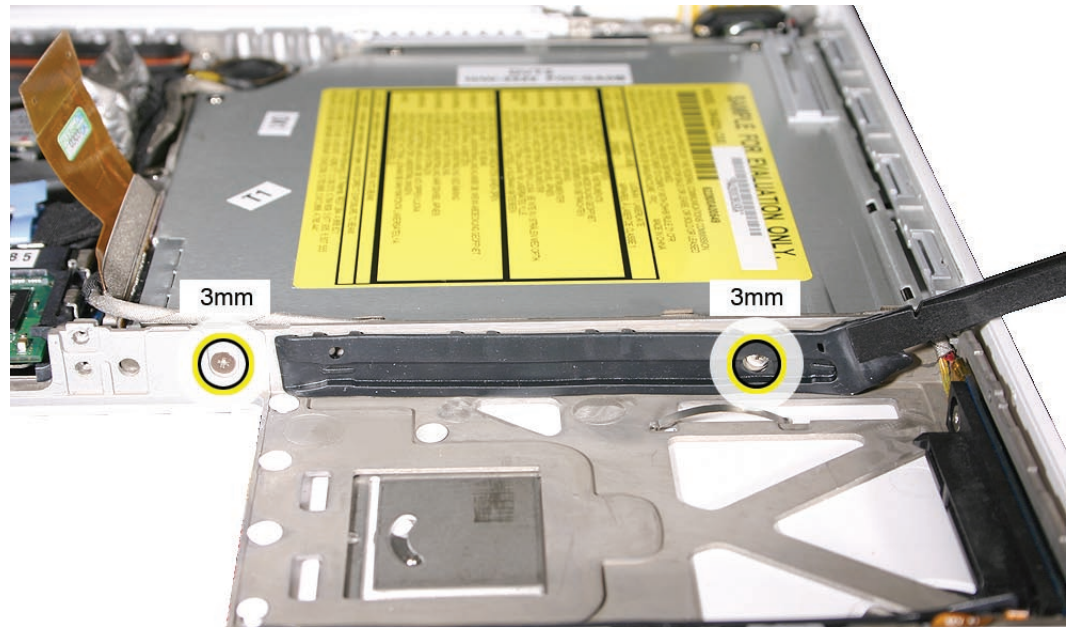

9. Lift up the cable that runs between the drive and the snubber at the lower edge of the optical drive.

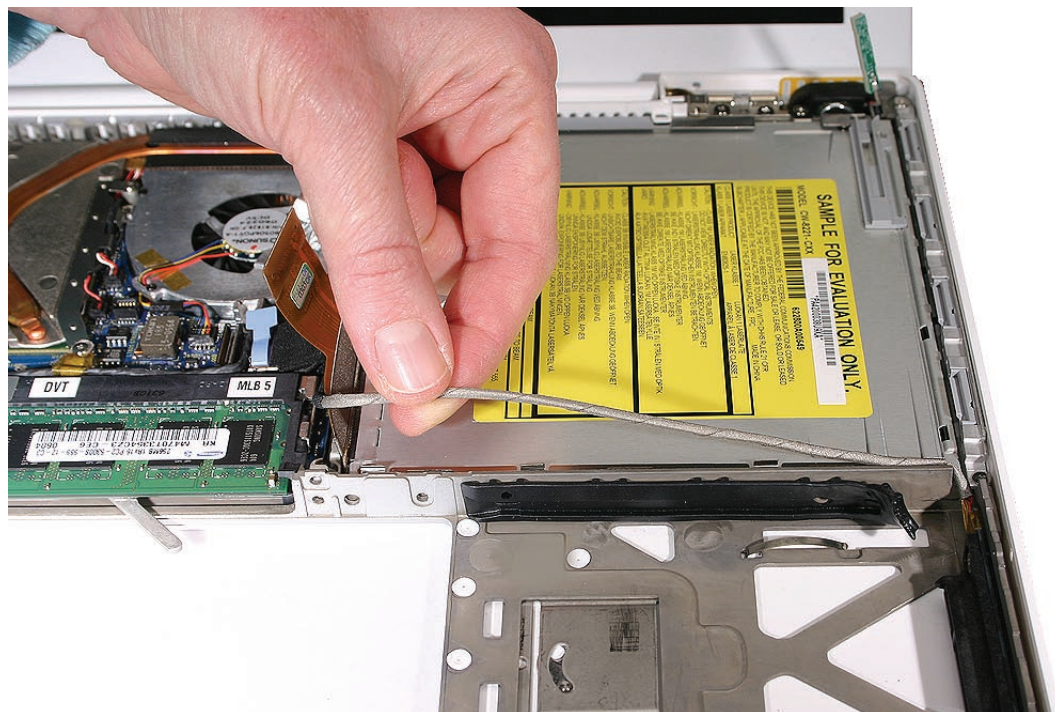

10. **Warning:** Handle the optical drive at the side edges only. Do not touch or press anywhere else on the drive.

11. Grasp the optical drive flex cable and use it as a pull tab as you tilt up the optical drive. Be careful where it can catch on cables.

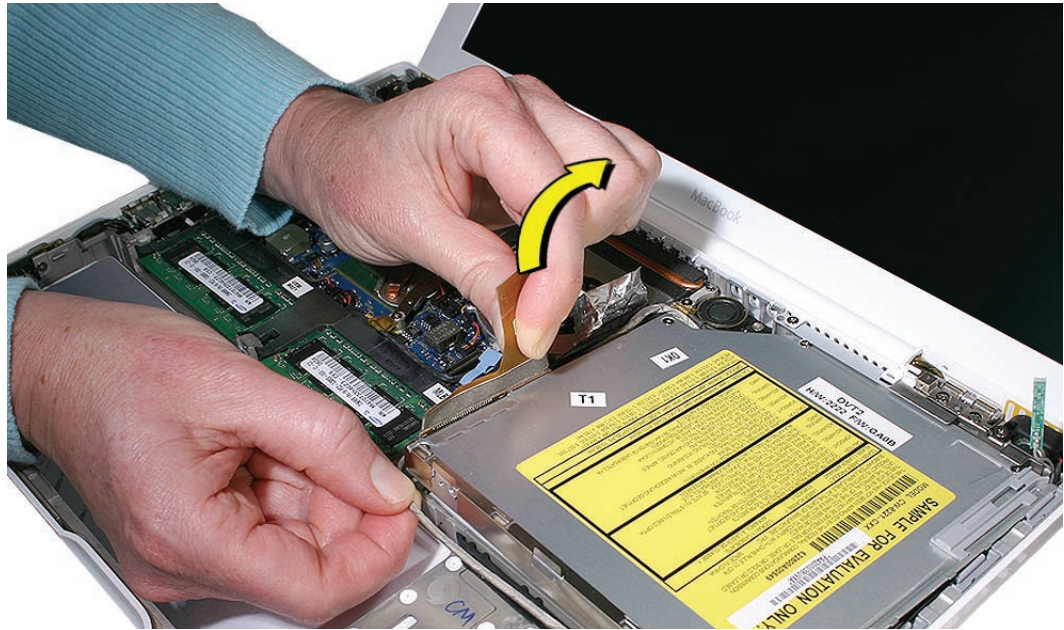

Replacement Note: Make sure the mounting bracket on the optical drive is pushed in before placing the optical drive in the bottom case.



Replacement Note: Reverse the screw order: install snubber screws first.

Replacement Note: If you are installing a replacement drive, check that it includes the following:

- Bluetooth holder
- Sliding bracket and two screws
- Cable guide rail

Replacement Note: If you are installing a replacement drive, check that the sliding bracket that is secured with two screws slides easily and is not too tight. If it is too tight, loosen the screws just enough so the bracket slides with ease.

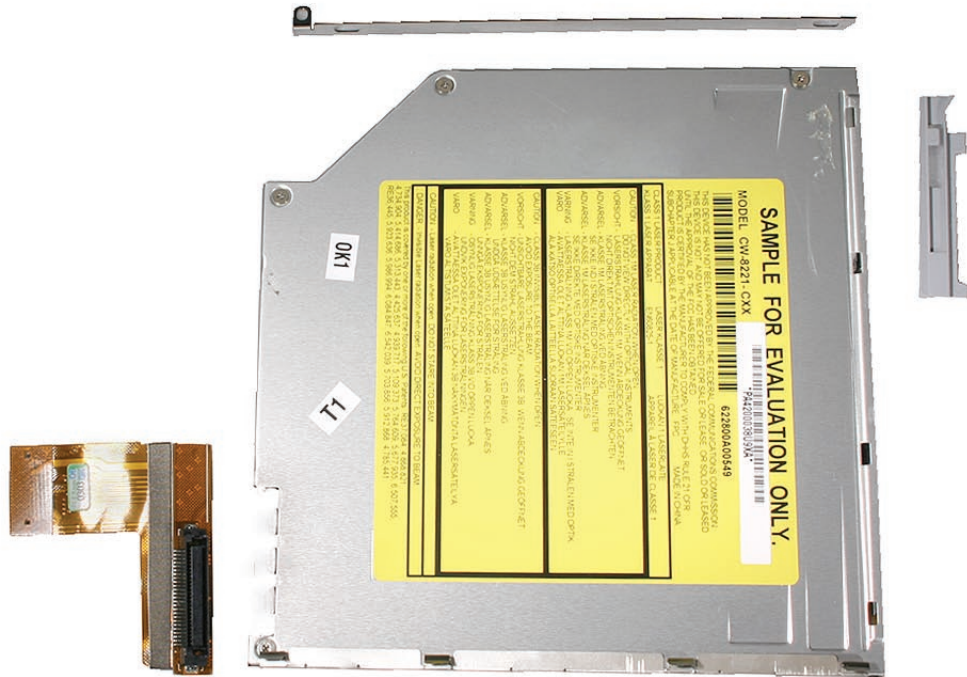

Note: For correct cable routing, refer to the image below:

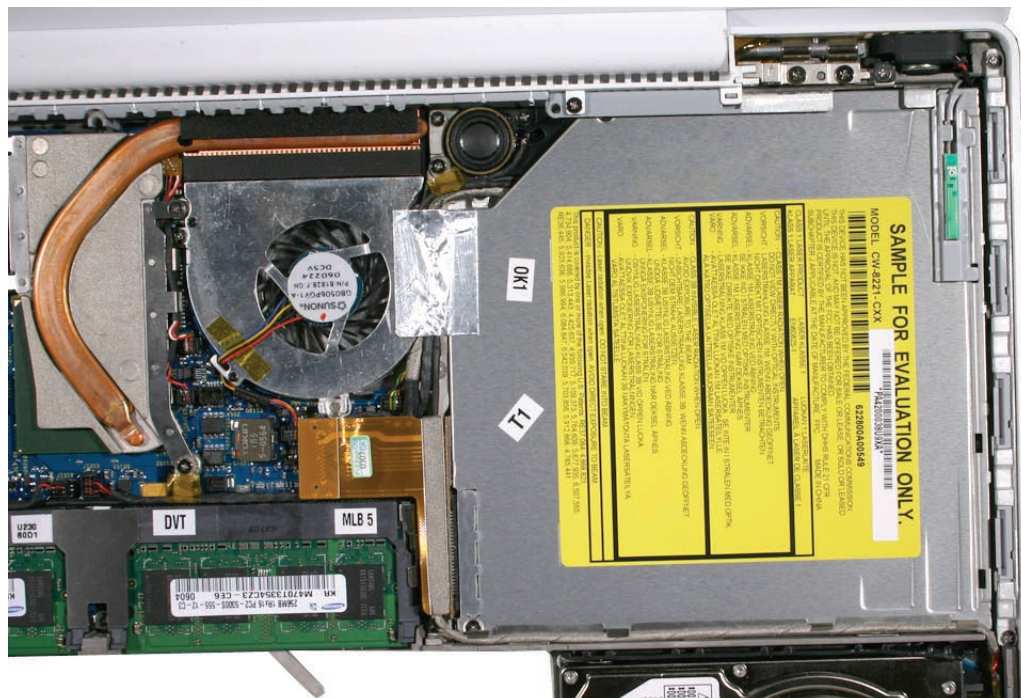

-
12. Before installing the optical drive, make sure the cables on the bottom case are routed as shown.

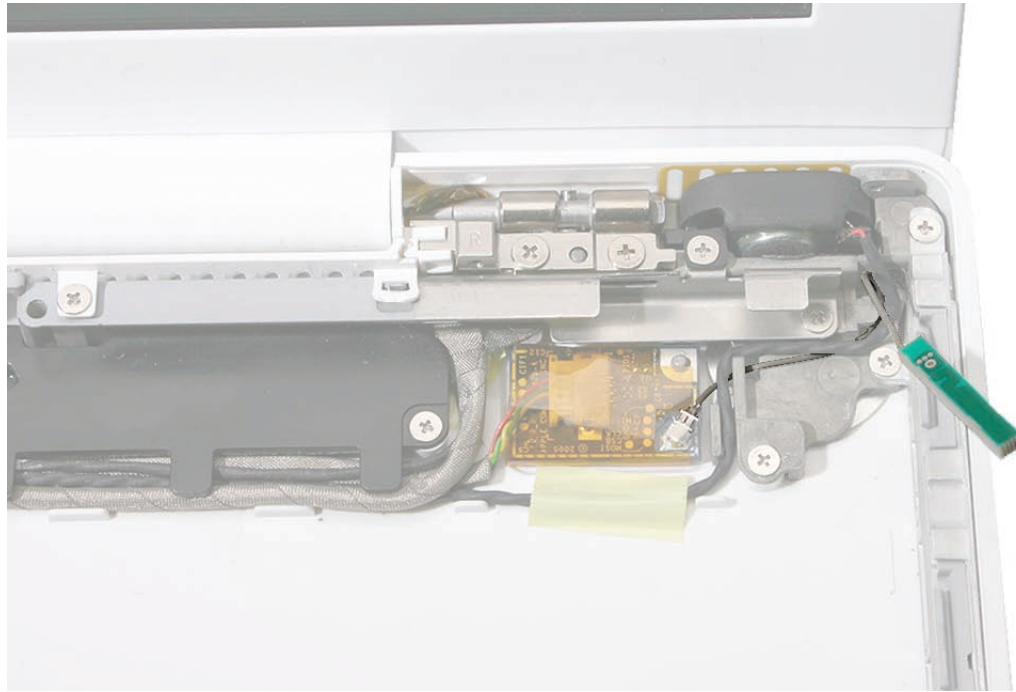

13. Install the replacement optical drive and reassemble and test the computer.

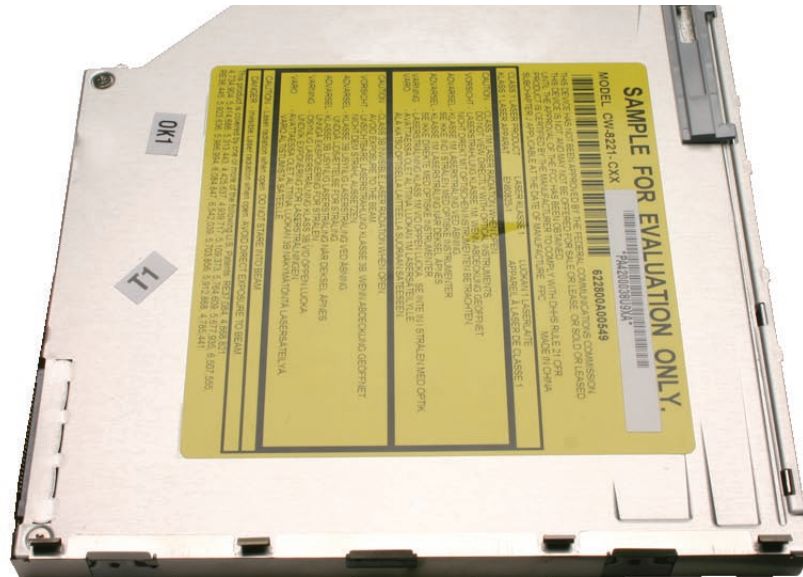

Late 2006 Model: (The blue tape is for controlling vibration; do not remove the tape)



Important: For best performance after a new optical drive replacement, be sure to update the operating system to the latest Mac OS X version.



Optical Drive Cable

Tools

- ESD wrist strap and mat
- Black stick (Apple part number 922-5065) or other nonconductive nylon or plastic flatblade tool

Preliminary Steps

Before you begin, remove

- Battery
- RAM door
- Top case with keyboard
- Optical drive

Part Location



Procedure

Warning: Handle the optical drive at the side edges only. Do not touch or press anywhere else on the drive.

1. With the optical drive on a clean, scratch-proof surface, use a black stick to evenly pry up the cable connector from the drive.

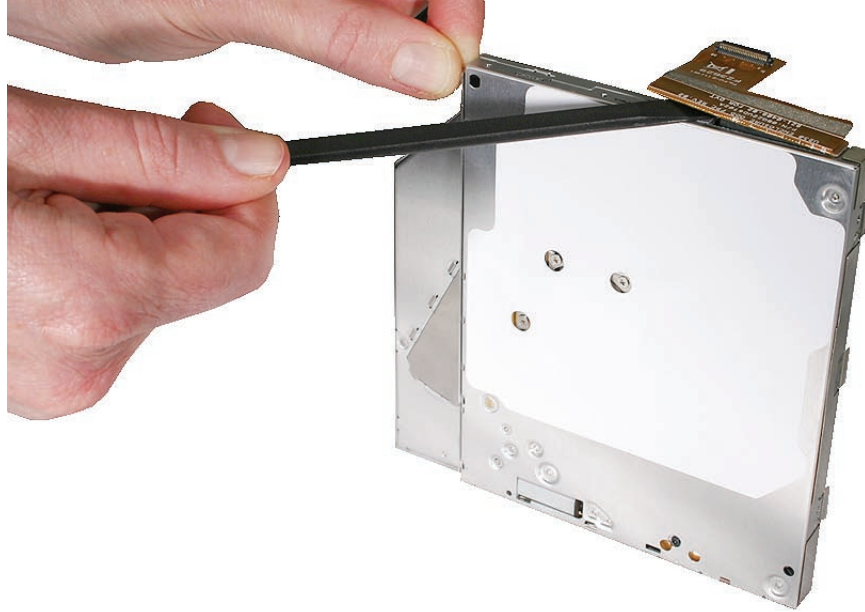

Late 2006 Model:

Carefully pry up the thin strip of black tape that overlaps the optical drive cable. Then pry up the connector from the drive.



-
2. Remove the optical drive cable.

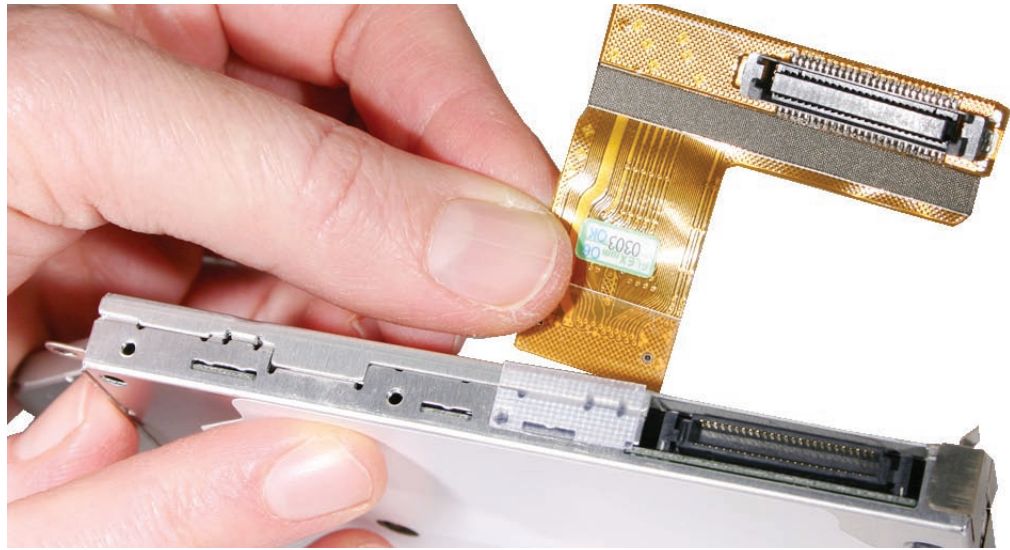

3. Install the replacement optical drive cable, and reassemble and test the computer.

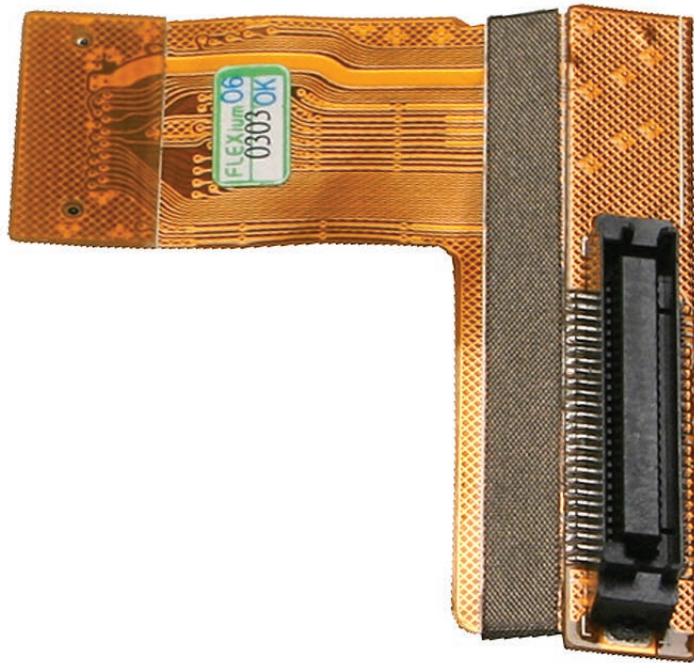

Note that both sides of the cable have an adhesive mesh strip.

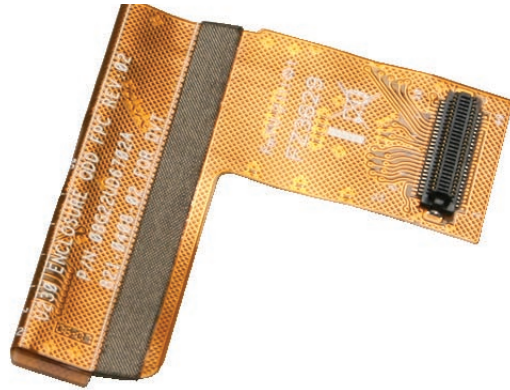



I/O Frame (with upper EMI shield)

Tools

- ESD wrist strap and mat
- Magnetic Phillips #0 screwdriver
- Black stick (Apple part number 922-5065) or other nonconductive nylon or plastic flatblade tool

Preliminary Steps

Before you begin, remove

- Battery
- RAM door
- Memory cards
- Top case with keyboard
- MagSafe DC-in board and
- AirPort Card
- Left speaker

Part Location

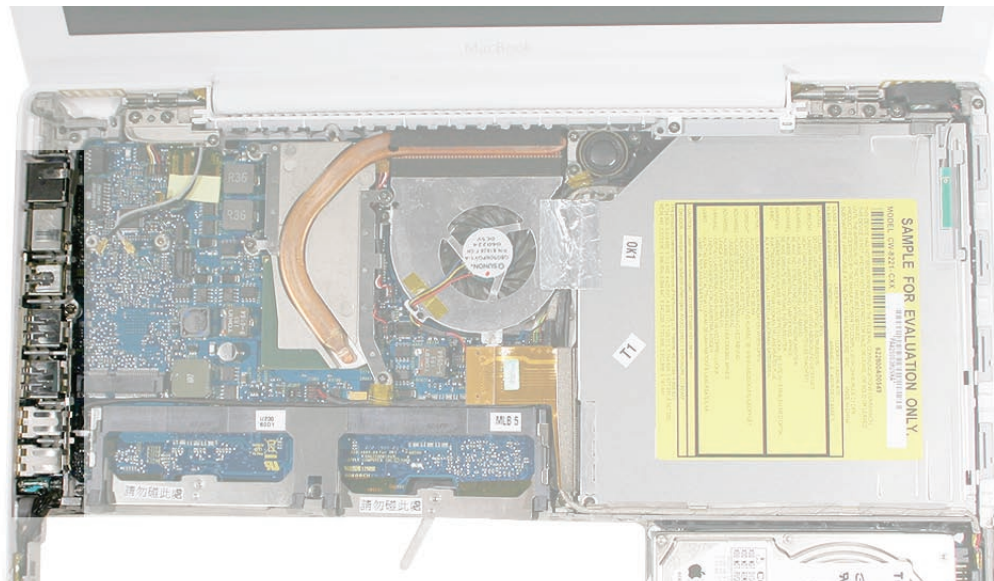

Procedure

1. At the left side of the computer assembly, remove the screws from the I/O frame:
 - Two identical 7.5-mm long screws (one at each end)
 - One 9.5-mm long screw in the middle

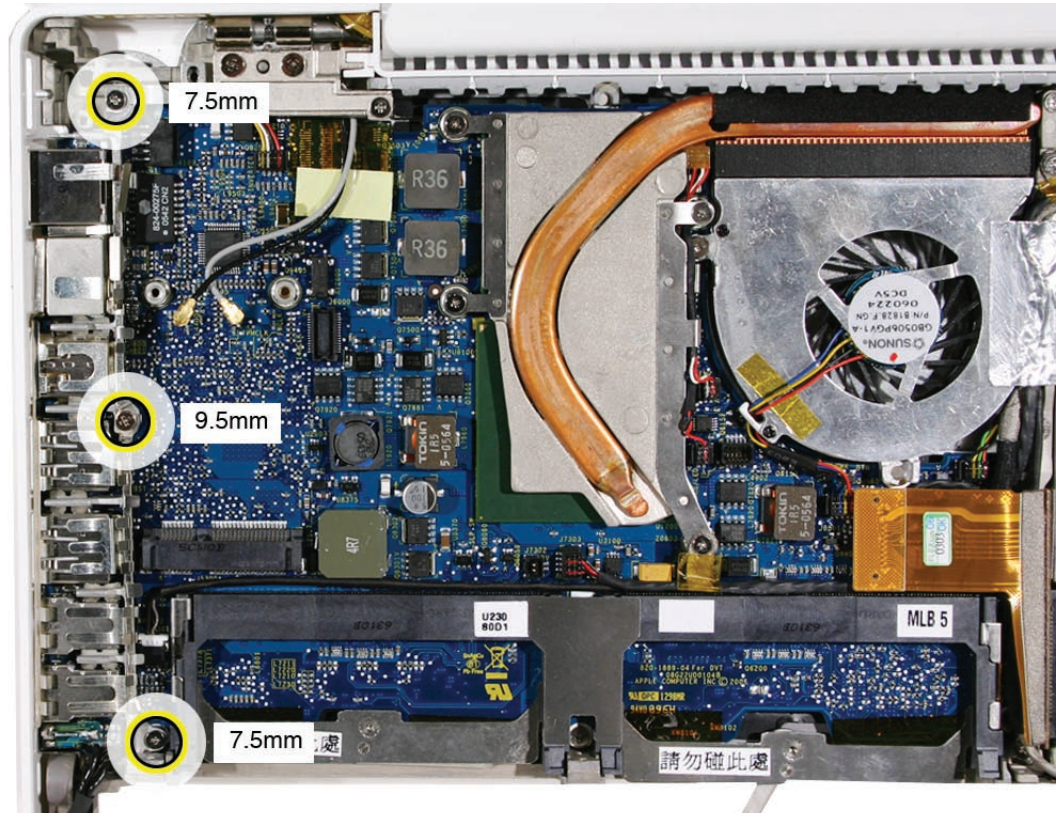

Replacement Note: If the I/O frame screw that is closest to the battery connector secures a battery cable clip, the screw length is 8 mm, not 7.5 mm.

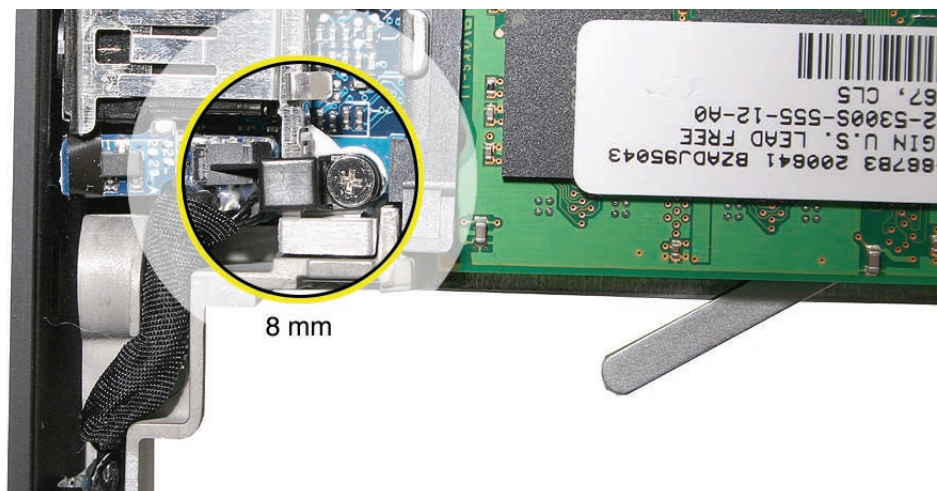

2. Note how the EMI shield on the I/O frame interlocks with the shield over the ports.
3. Tilt up the I/O frame to remove it from the computer assembly.

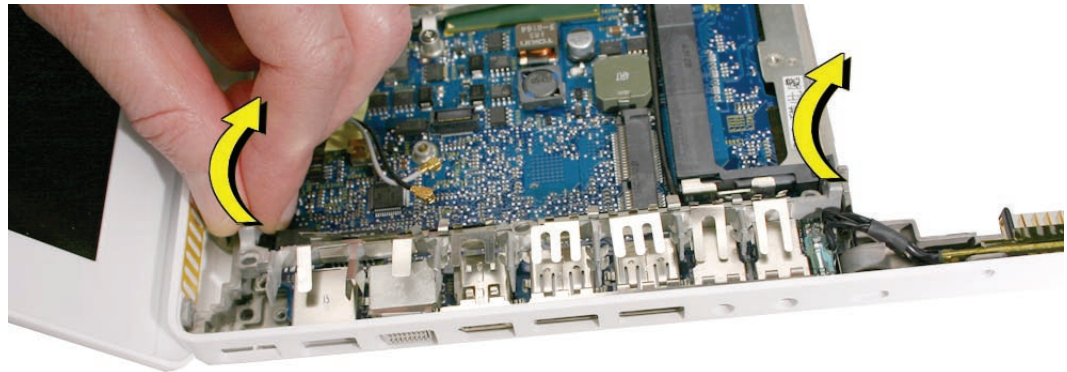

Note that the I/O frame includes the EMI shield. Be careful not to bend the shield as you remove or install it.



4. Install the replacement I/O frame, and reassemble and test the display.

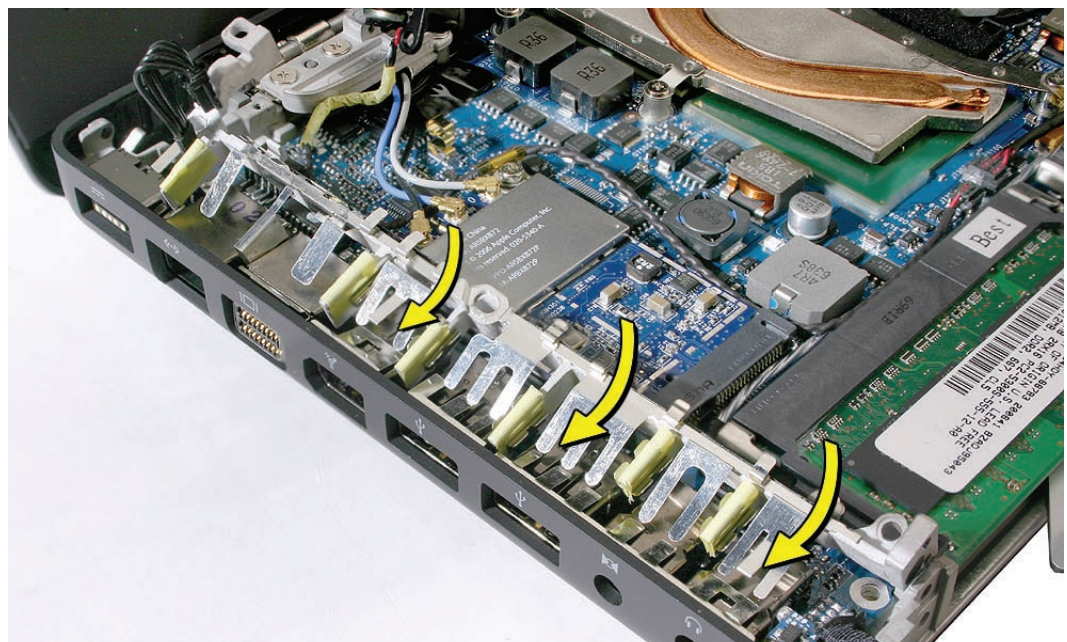

Replacement Note: If the I/O frame screw that is closest to the battery connector secures a battery cable clip, be sure to reinstall the cable clip and screw.

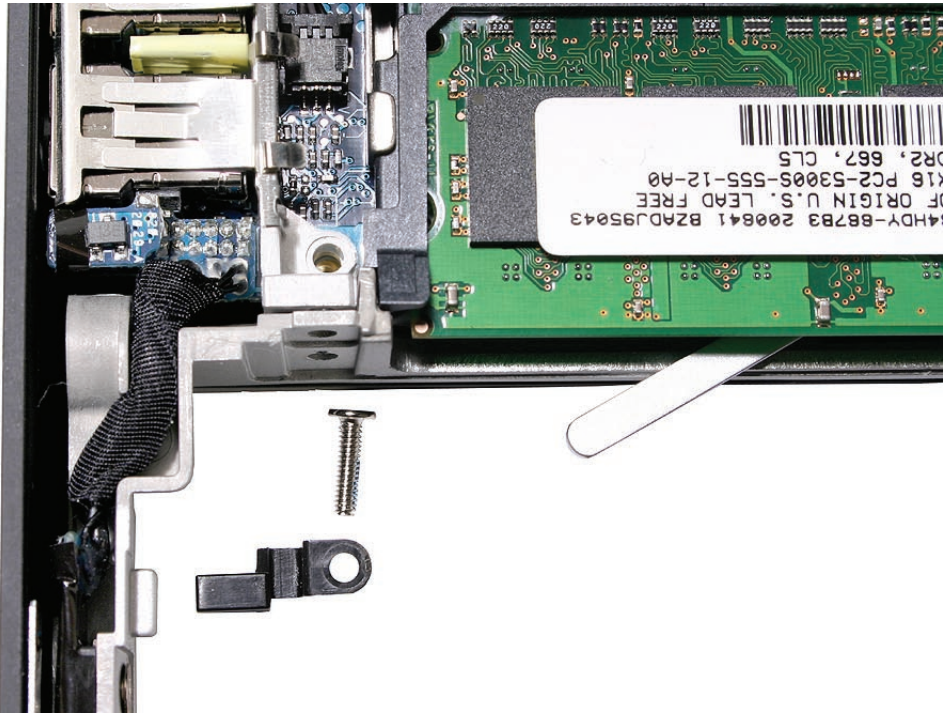



Logic Board

Tools

- ESD wrist strap and mat
- Magnetic Phillips #0 screwdriver
- Black stick (Apple part number 922-5065) or other nonconductive nylon or plastic flatblade tool
- Stack of books, weighted boxes, or other means of support for display while removing and replacing left clutch block
- Alcohol wipes
- Thermal grease (Apple part number 922-7144)
- Felt-tip pen

Preliminary Steps

Before you begin, remove

- Battery
- RAM door
- Memory cards
- Top case with keyboard
- AirPort Extreme Card
- MagSafe DC-in board and cable
- Left speaker
- I/O frame with upper EMI shield
- Fan
- Heatsink

Part Location

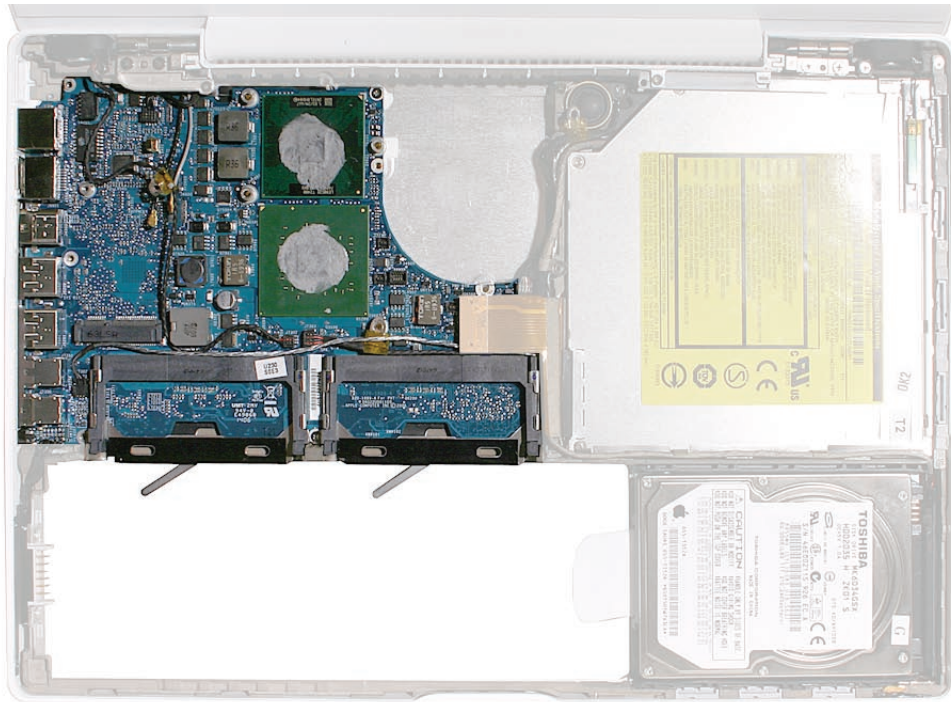

(image 2490)

Procedure

1. Disconnect the optical drive flex cable from the logic board.

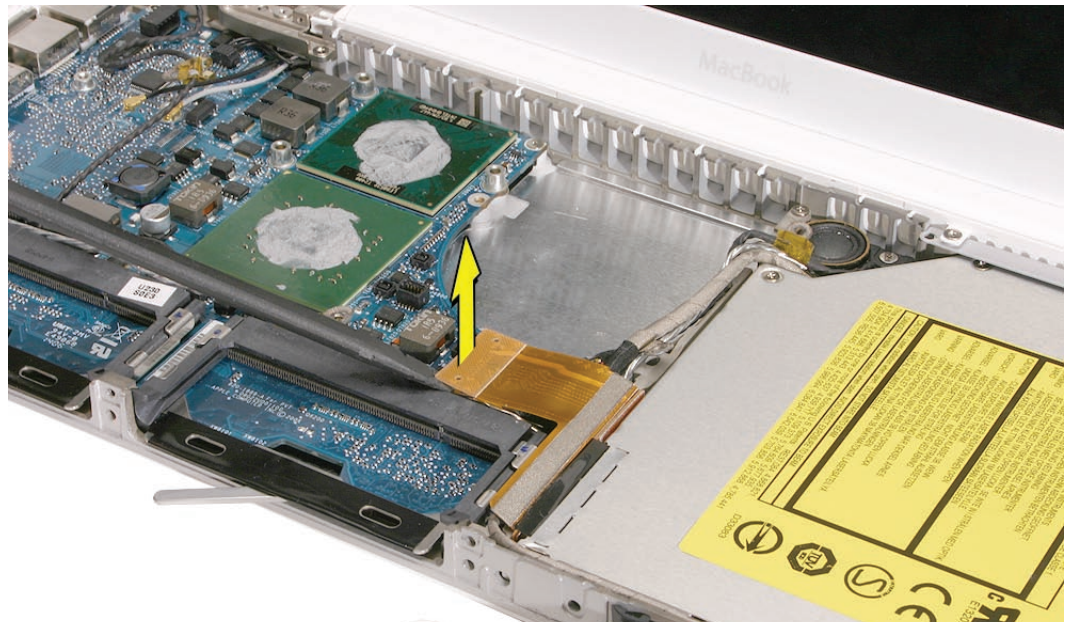

- Without straining the optical drive flex cable, note the position of the LVDS cable beneath it. Pull the pull-tab to disconnect the LVDS cable from the logic board.

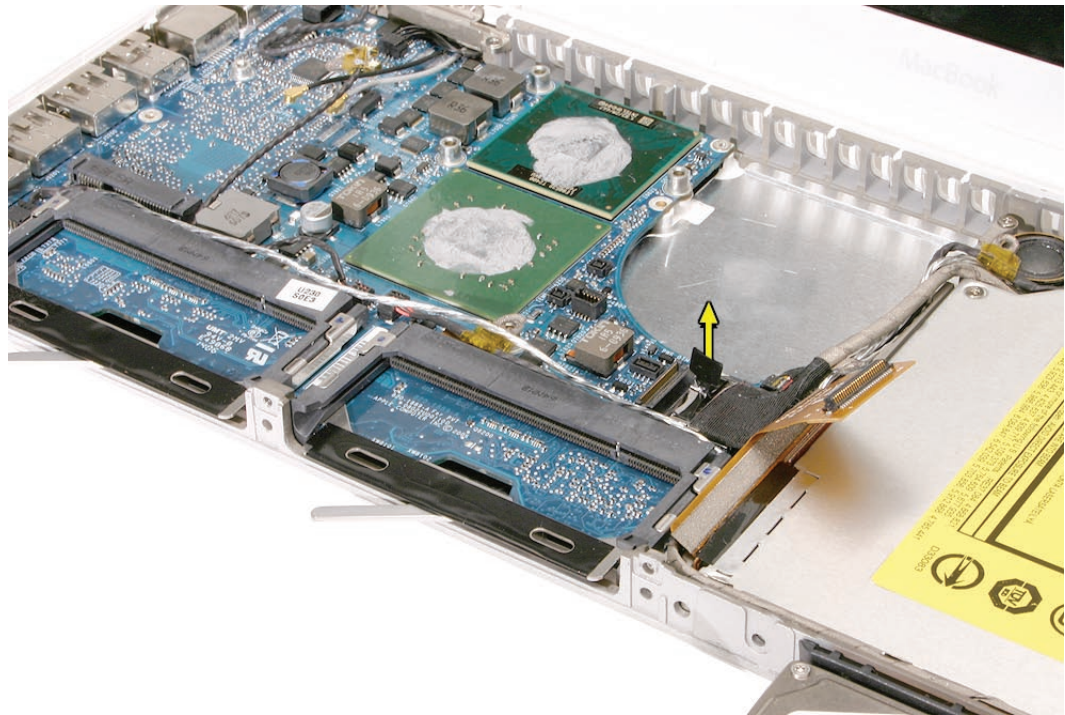

- Locate the Bluetooth antenna cable at the edge of the logic board, and disconnect the Bluetooth antenna cable. Pull the pull-tab to disconnect the hard drive cable connector.



4. Remove the 3-mm long screw next to the lower end of the midframe.

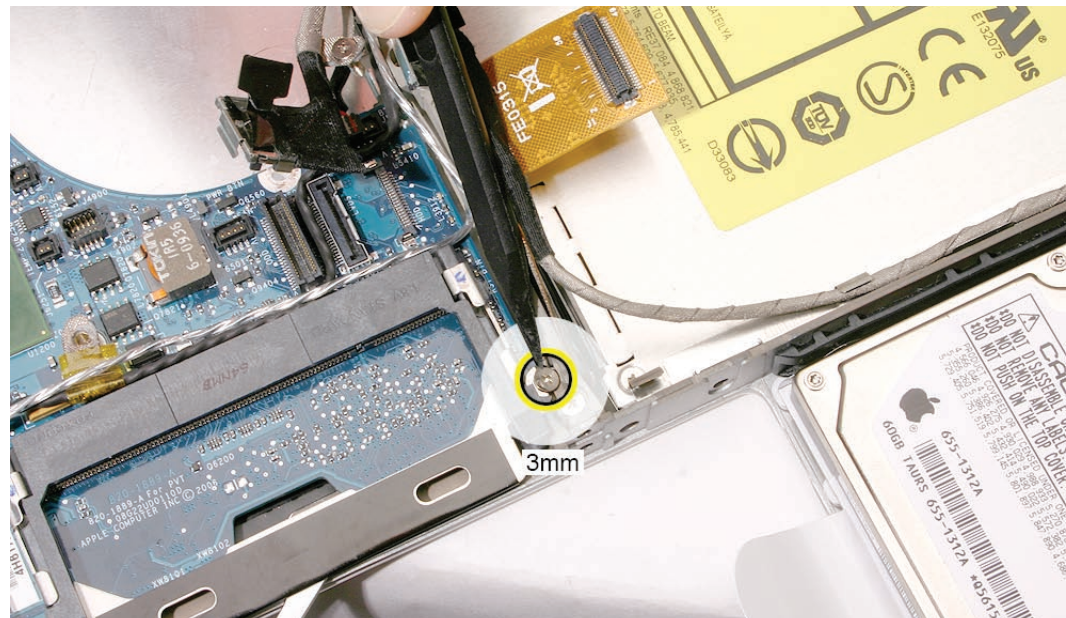

5. Remove the 3-mm long screw located between the memory card carriers, and disconnect the following cables:
 - sleep switch connector (use a black stick to raise up and disconnect it)
 - microphone cable
 - left speaker cable
 - subwoofer/right speaker cable

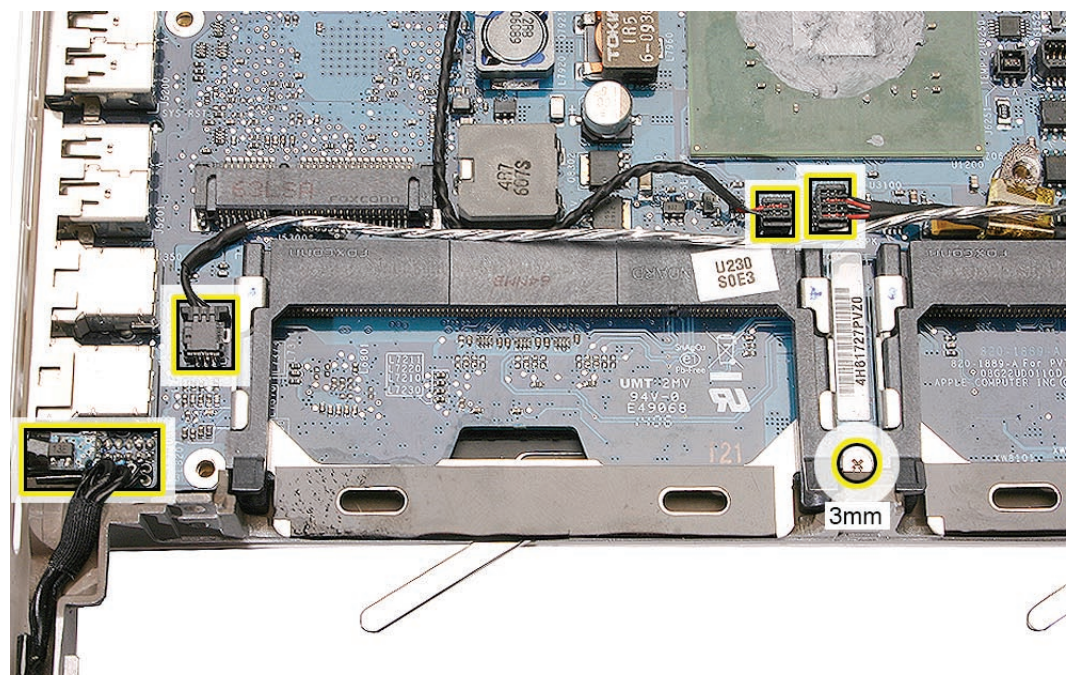

6. Place a heavy box behind the display to help support it (refer to “Clutch Block, Left” for more details). Disconnect the inverter cable, and remove the following screws:
 - 10-mm long thick-stemmed outer screw, closest to the left corner of the bottom case
 - 6-mm long thick-stemmed middle screw
 - 6-mm long thin-stemmed inner screw, closest to the antenna cables
 - 3-mm long screw from the upper right area of the board.

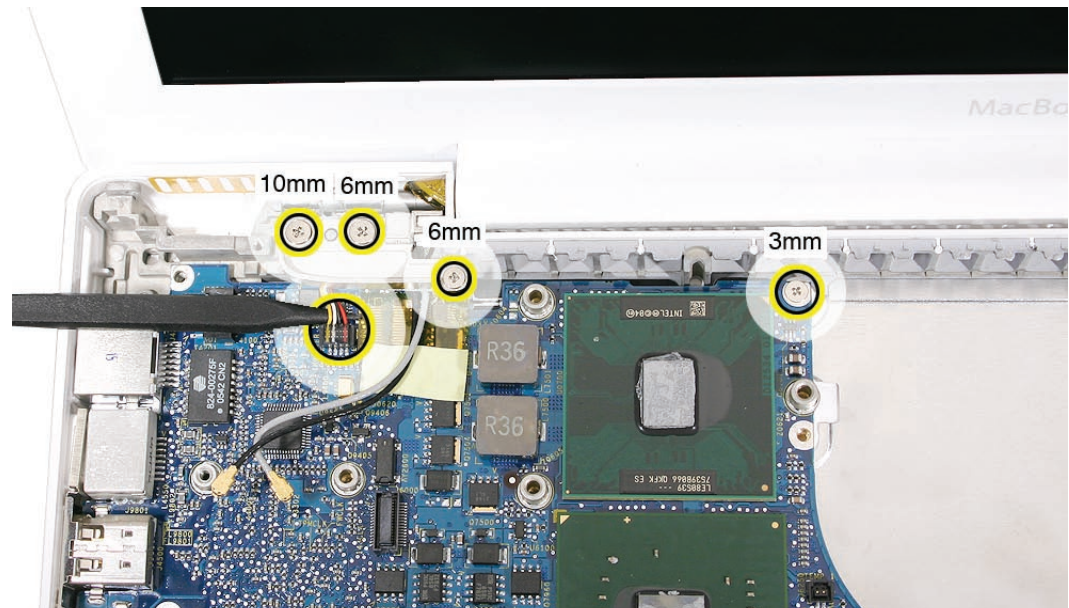

7. Remove the left clutch block and clutch cap, and move aside any cables that overlap the logic board.

Note: Disregard the cable assembly state shown in the image below.

Replacement Note: When reinstalling the clutch block, refer to “Clutch Block, Left” in this chapter.

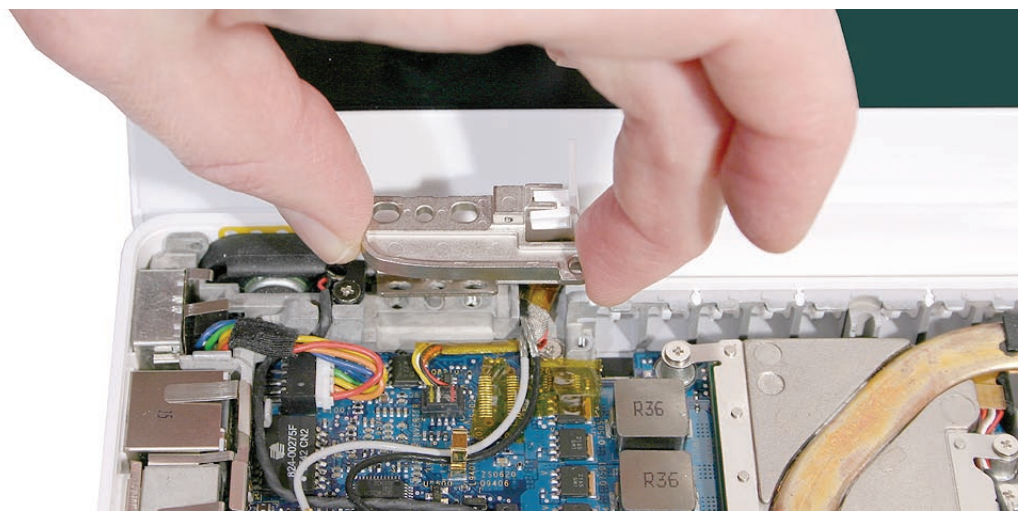

-
8. Holding the logic board by its right side, tilt it up and with a small rocking motion, remove it at an angle away from the I/O ports. You might find it helpful to use a black stick between the side of the bottom housing and the ports.

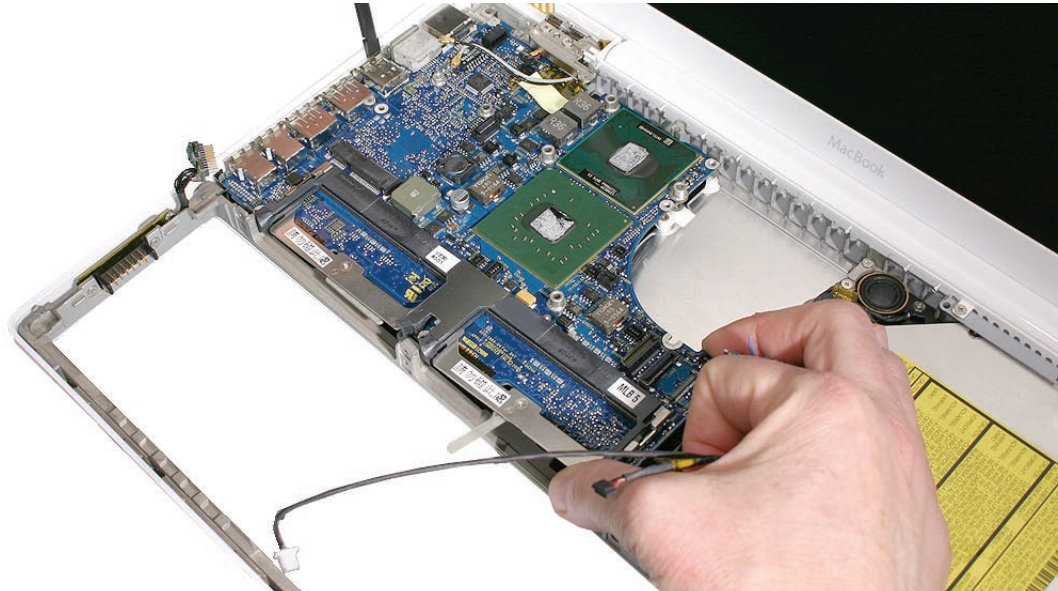

Replacement Note: When replacing the logic board, make sure all cables are kept clear of the board, and the I/O shield is securely positioned along the ports. Use a black stick, if necessary, to slightly flex the port side of the bottom case to install the logic board.

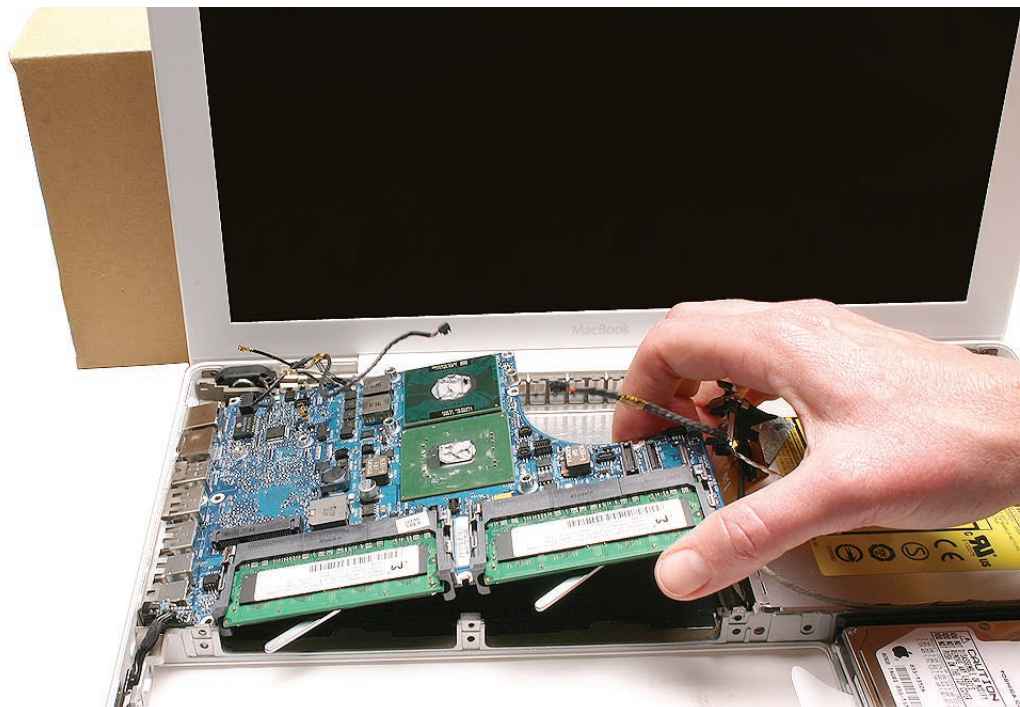

-
9. If you are installing a new logic board, transfer the following parts to the replacement board:
- Backup battery on the underside of the logic board (Refer to Backup Battery in this chapter)

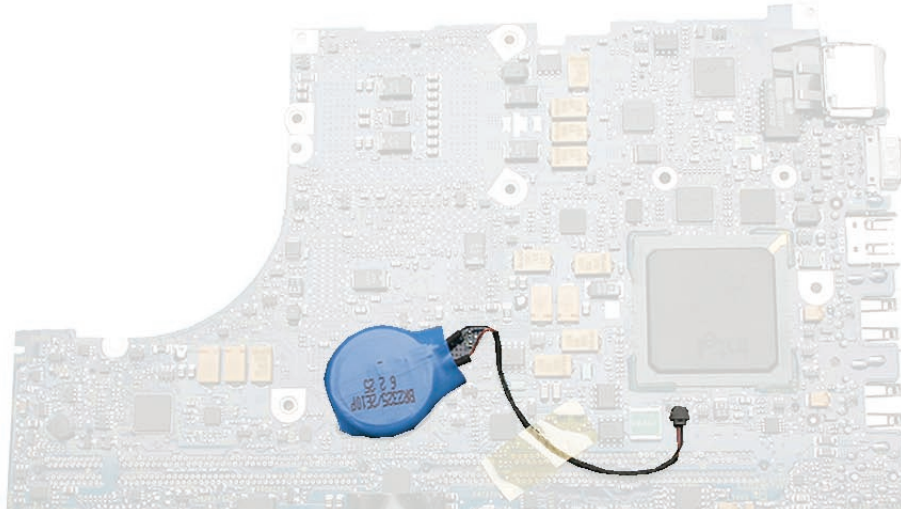

- Tape at the edge of the board between the inverter connector and the large chip
- AirPort Extreme Card
- Memory cards
- I/O shield

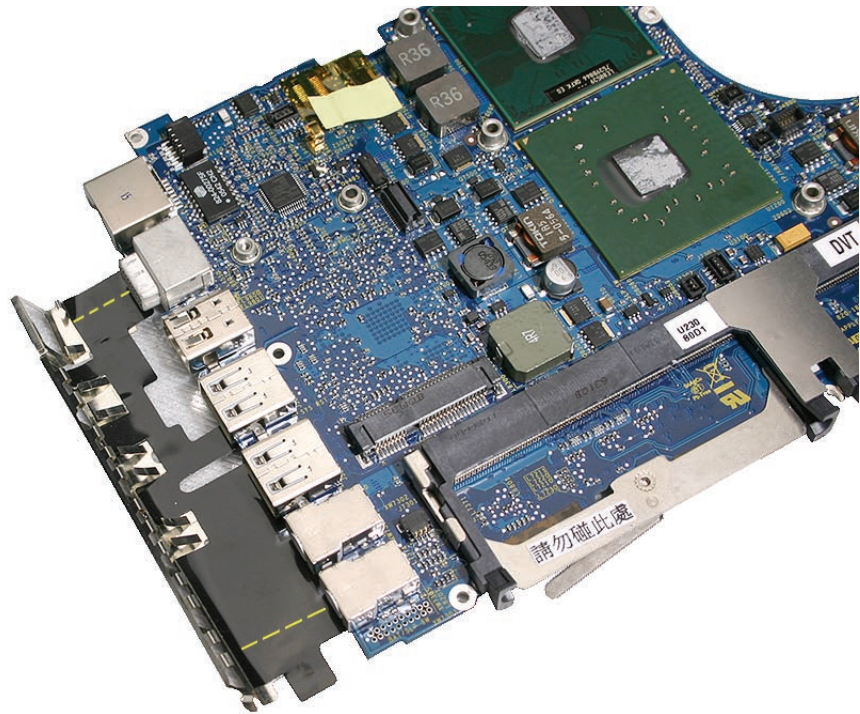

10. Before installing the logic board, make sure the gold-colored spring located beneath the inverter cable connector is intact (not bent or broken).



11. Before installing the logic board, check the locator pins on the bottom case. Make sure the two openings in the logic board fit over the “+”-shaped locator pins.

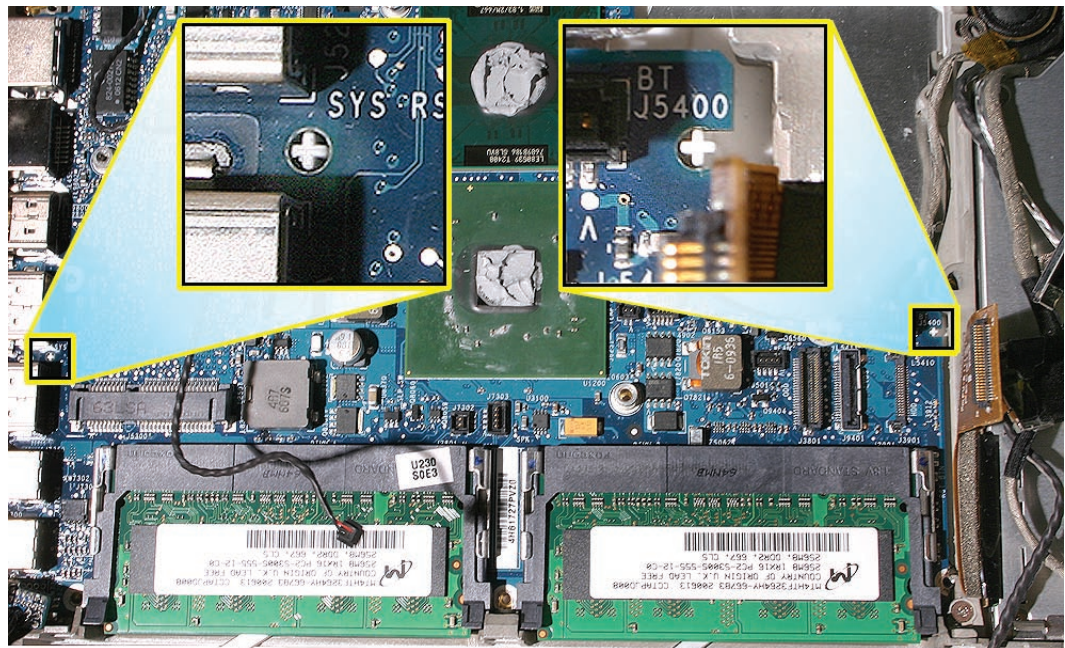

12. **Warning:** Whenever the heatsink is separated from the logic board (even if you are installing the same logic board or heatsink), the thermal grease must be checked and possibly replaced. Failure to do so can cause the computer to overheat and be damaged. Refer to “Checking the Thermal Grease” in the Heatsink section.

13. Install the replacement logic board, and reassemble and test the computer.

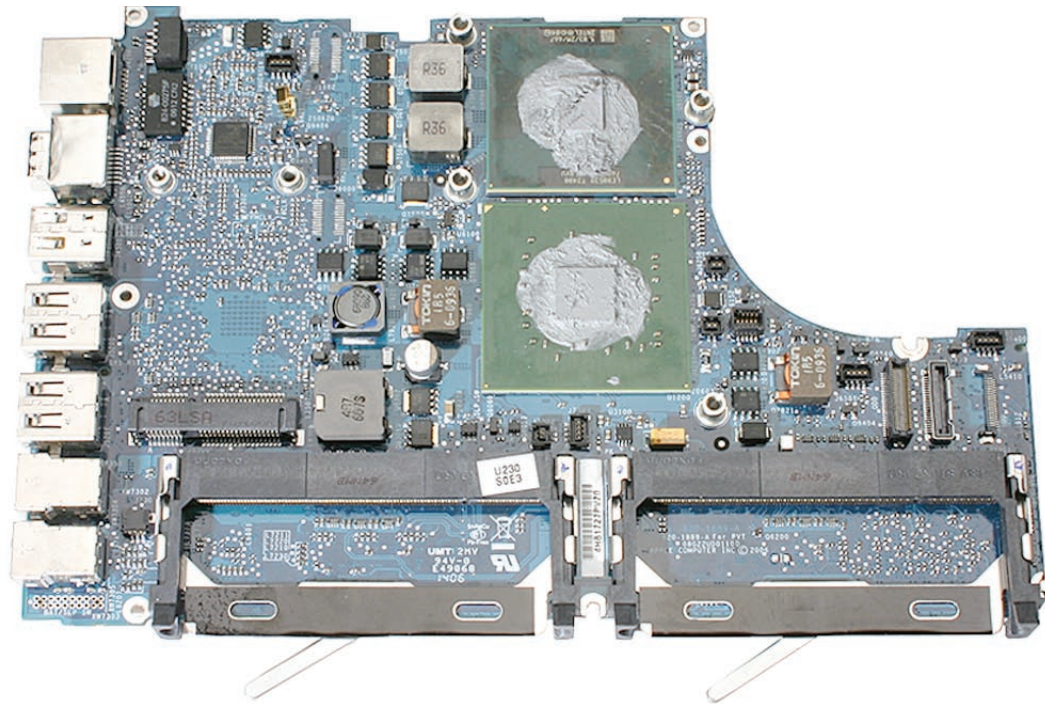



DIMM Lever Kit

Tools

- ESD wrist strap and mat
- Magnetic Phillips #0 screwdriver
- Black stick (Apple part number 922-5065) or other nonconductive nylon or plastic flatblade tool

Preliminary Steps

Before you begin, remove

- Battery
- RAM door
- Memory cards
- Top case with keyboard
- AirPort Extreme Card
- MagSafe DC-in board and cable
- I/O frame with upper EMI shield
- Fan
- Heatsink
- Logic Board

Part Location

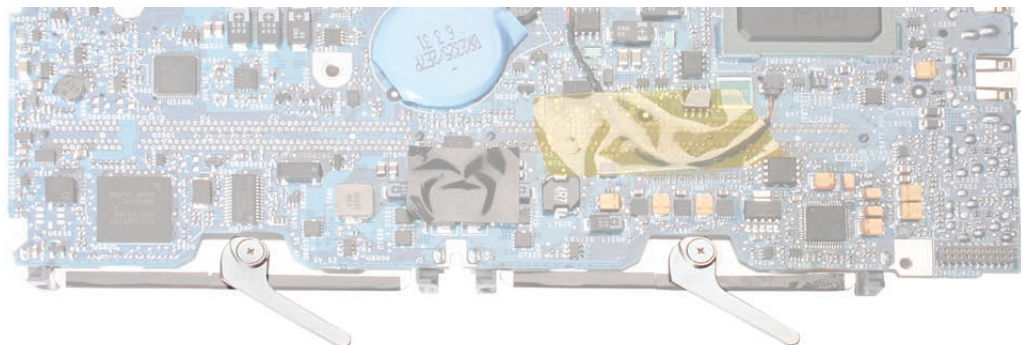

Procedure

Important: The following image shows the memory cards and hard drive installed in the battery bay. Note the correct position of the memory card levers.

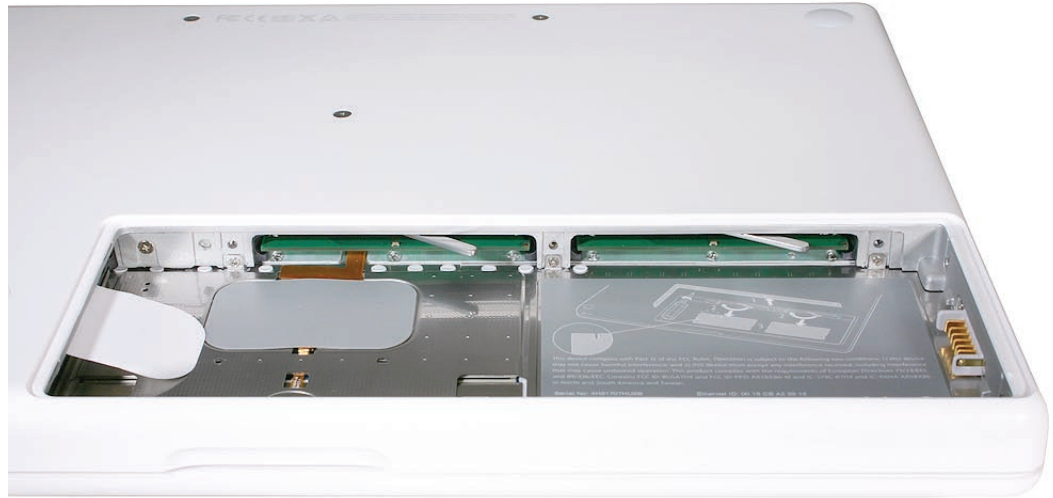

Caution: The remaining images pictured in this procedure used a pre-production model, so the direction and appearance of the levers differ from the computer that you are servicing. However, the steps should be the same.

1. On the underside of the logic board, use light pressure with a Phillips screwdriver to remove the 3-mm long lever screw. (Remove both screws if replacing both levers.)

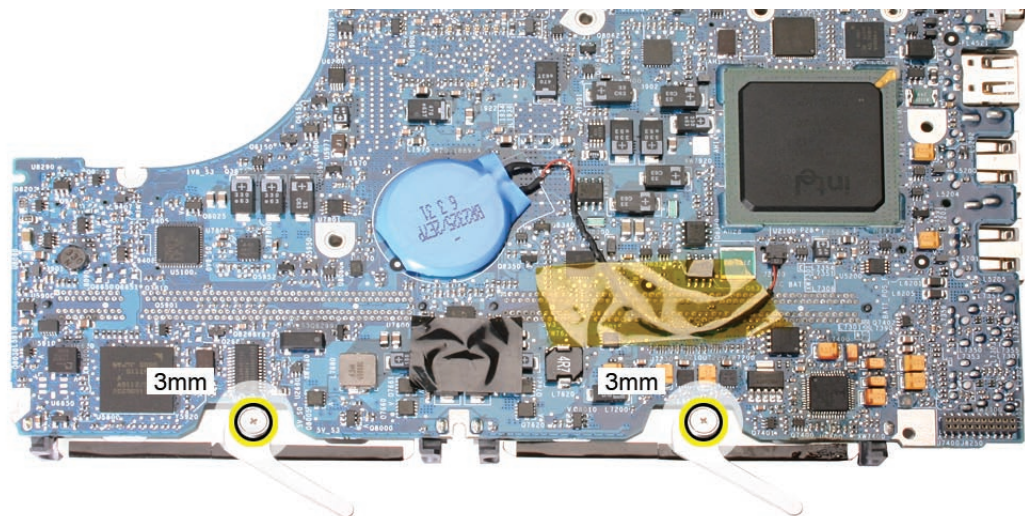

2. Lift off the lever, and remove the spring.

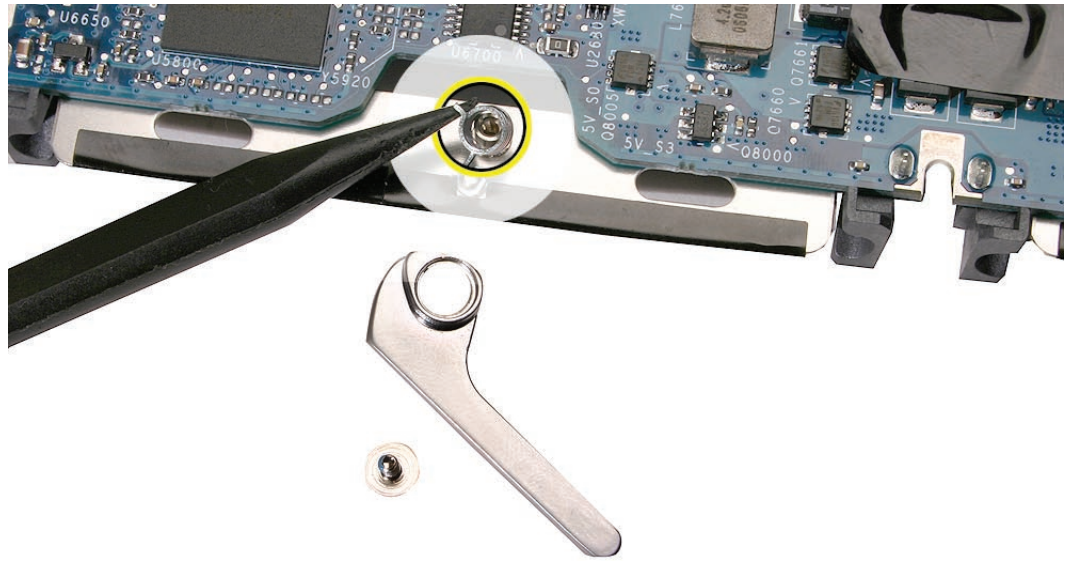

3. Note that the spring has a "hook" end and a "stem" end. When replacing the spring, make sure the hook end wraps around the pin on the memory card carrier..

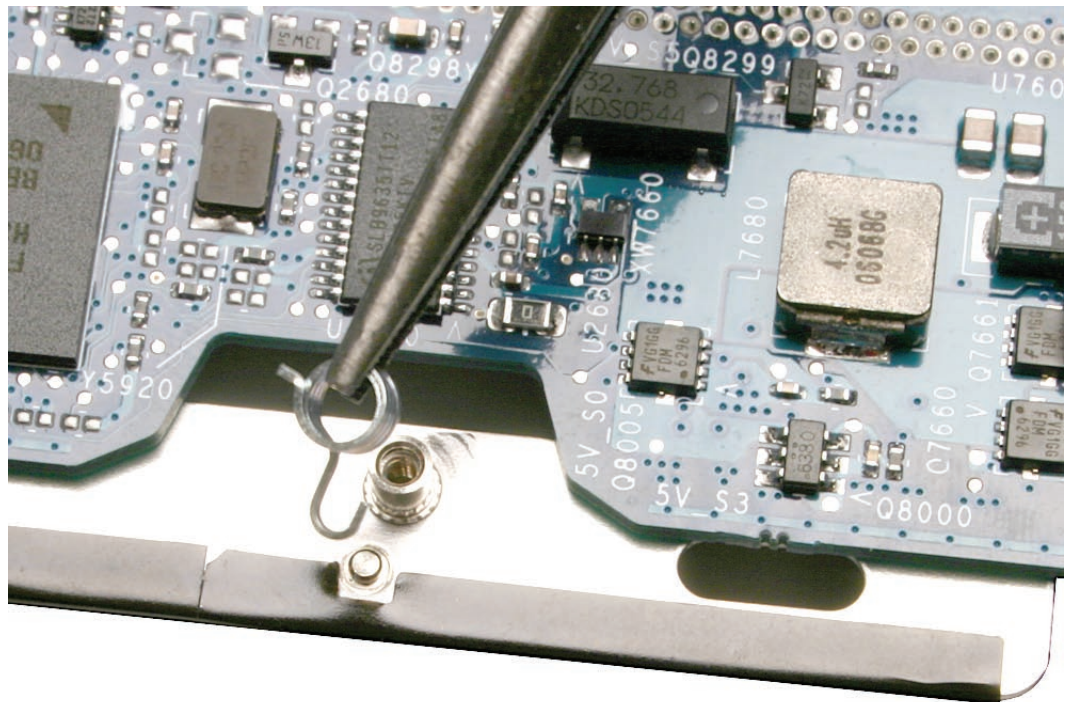

4. Before installing the replacement lever and spring, note that the underside of the lever has an indentation that mates with the spring stem.

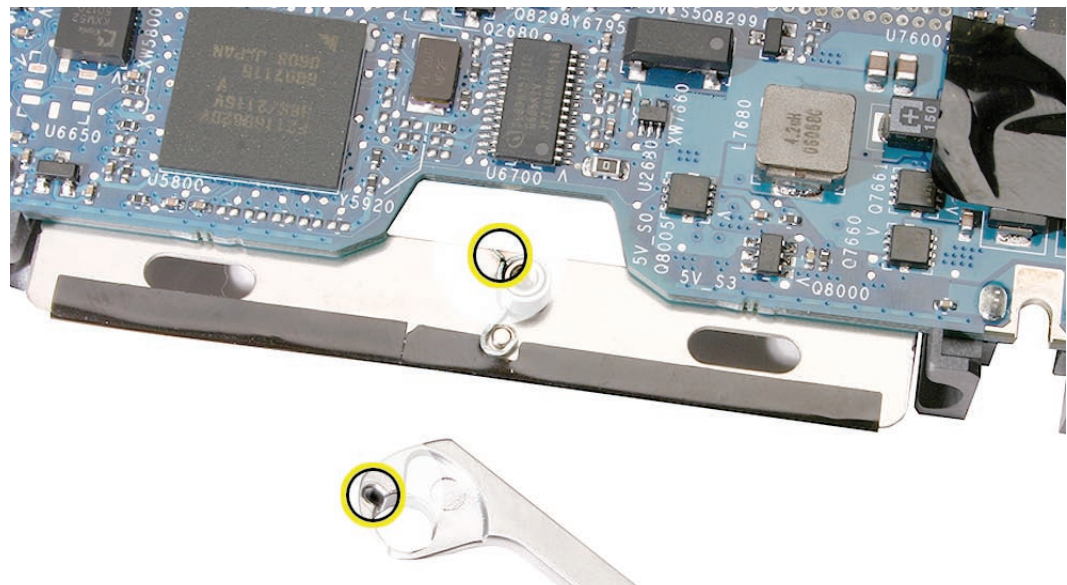

5. Install the replacement lever, spring, and screw, and check that the lever moves correctly. Reassemble and test the computer.

Replacement Note: Test the function of the newly installed lever. If it is correctly installed, the spring should offer some resistance, and when you hold it all the way to the left, you should see the spring hook.

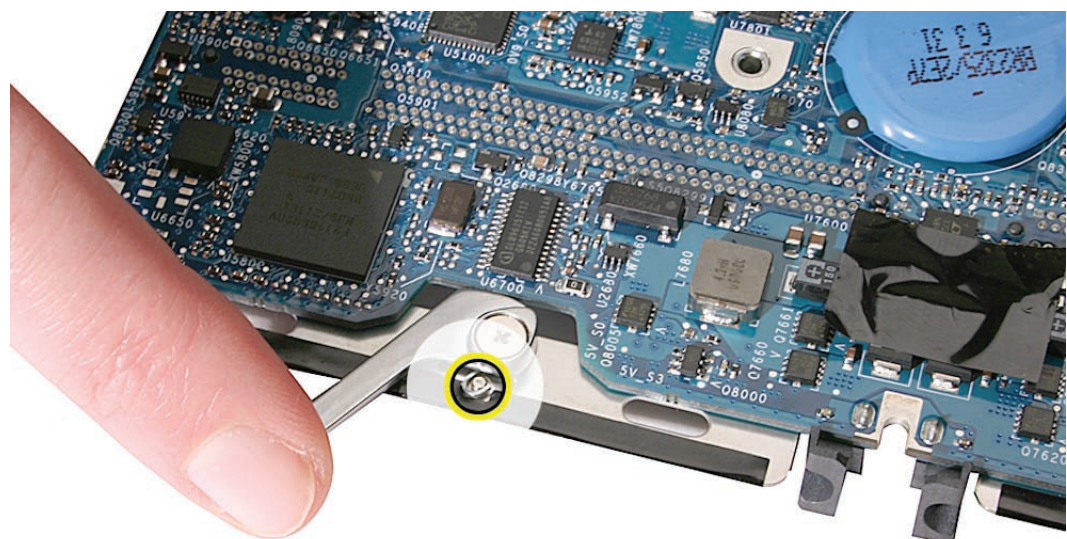

Replacement Note: The lever kit includes two levers, two springs, and two screws.



Backup Battery

Tools

- ESD wrist strap and mat
- Black stick (Apple part number 922-5065) or other nonconductive nylon or plastic flatblade tool

Before you begin, remove

- Battery
- RAM door
- Memory cards
- Top case with keyboard
- AirPort Extreme Card
- MagSafe DC-in board and cable
- I/O frame with upper EMI shield
- Fan
- Heatsink
- Logic board

Part Location

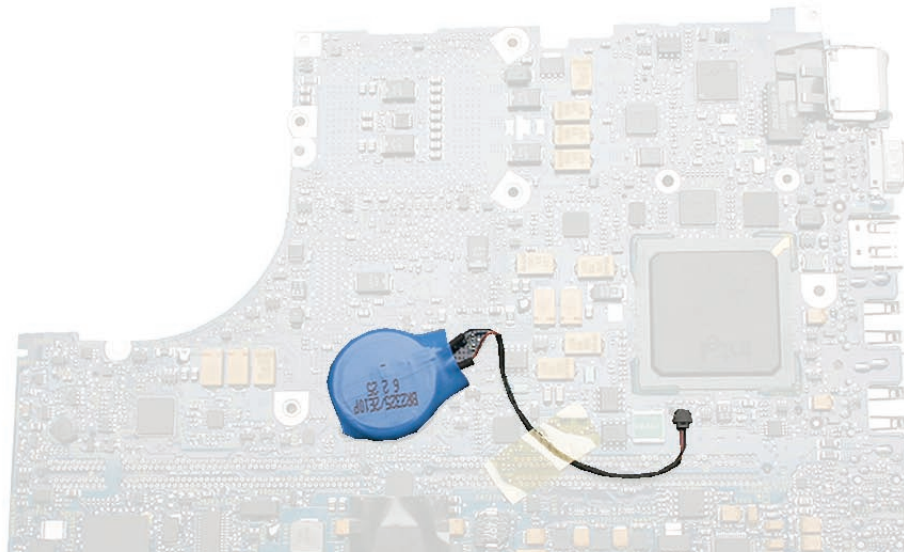

Procedure

1. On the underside of the logic board, note the position of the backup battery, attached cable, and tape.

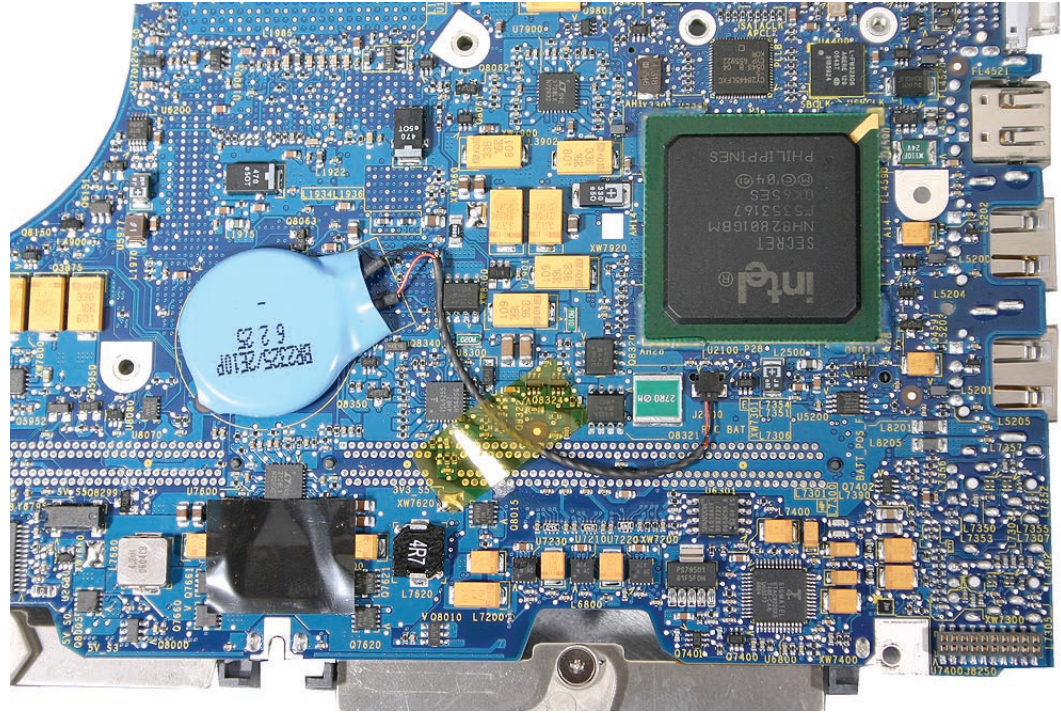

2. Using your fingers or a black stick, carefully peel up the backup battery from the adhesive on the logic board.

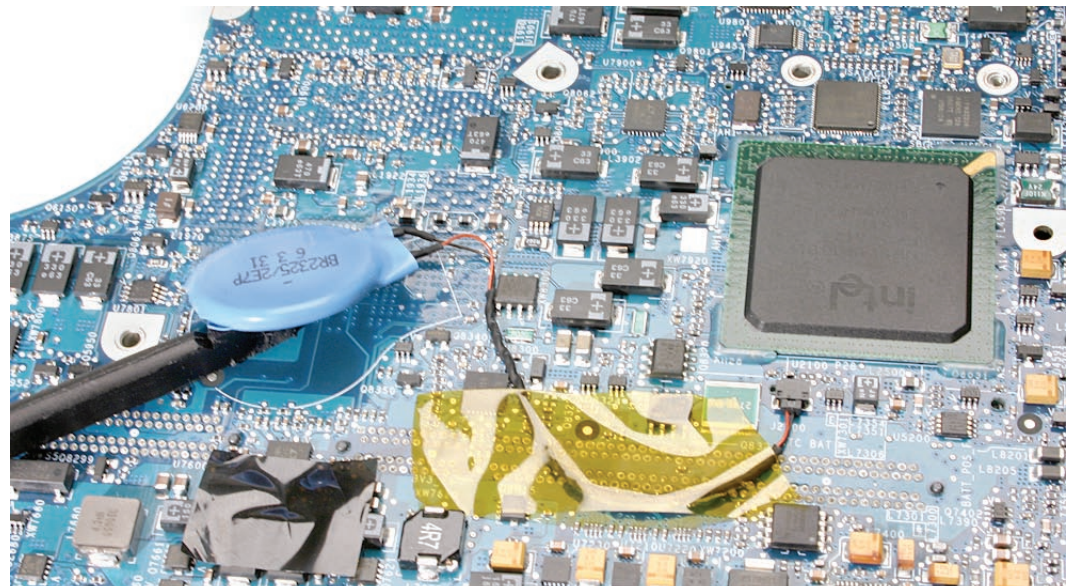

3. Peel up the tape that holds the backup battery cable in place.
4. Disconnect the cable by pulling the cable straight out from the connector.

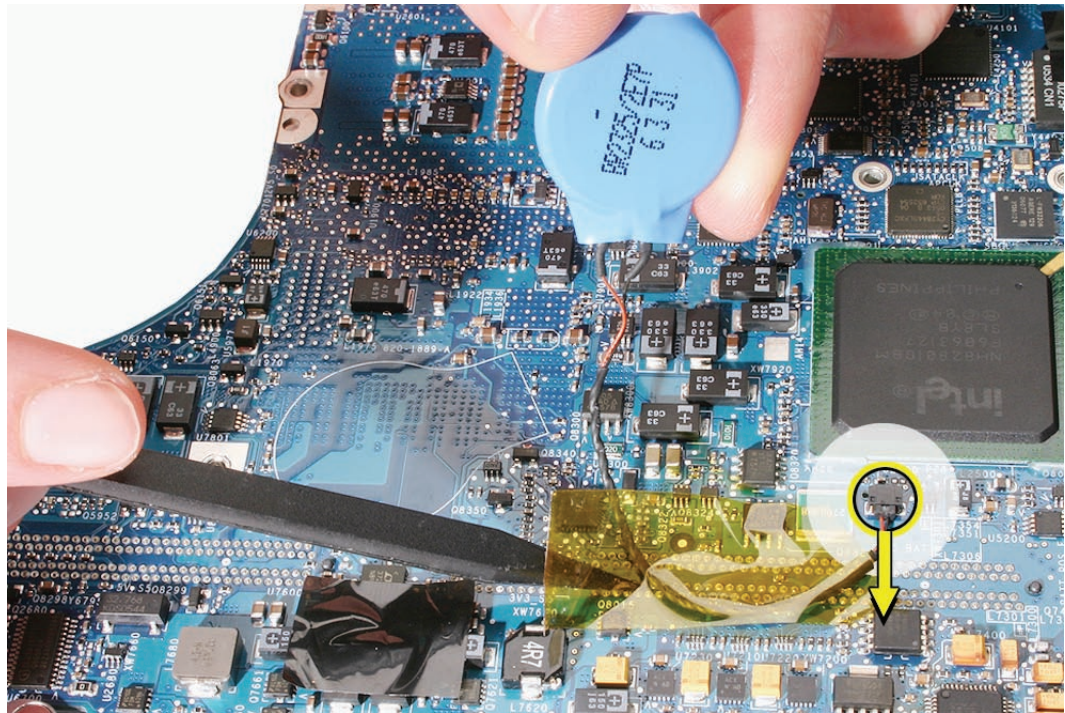

Replacement Note: If you are replacing the backup battery with a new one, peel the adhesive backing off of the replacement battery, and use a black stick to remove any old adhesive from the board.

5. Install the replacement backup battery within the outline printed on the logic board, and reassemble and test the computer.





Bluetooth Antenna Board and Cable

Tools

- ESD wrist strap and mat
- Magnetic Phillips #0 screwdriver
- Black stick (Apple part number 922-5065) or other nonconductive nylon or plastic flatblade tool

Preliminary Steps

Before you begin, remove

- Battery
- RAM door
- Top case with keyboard
- Optical drive

Part Location

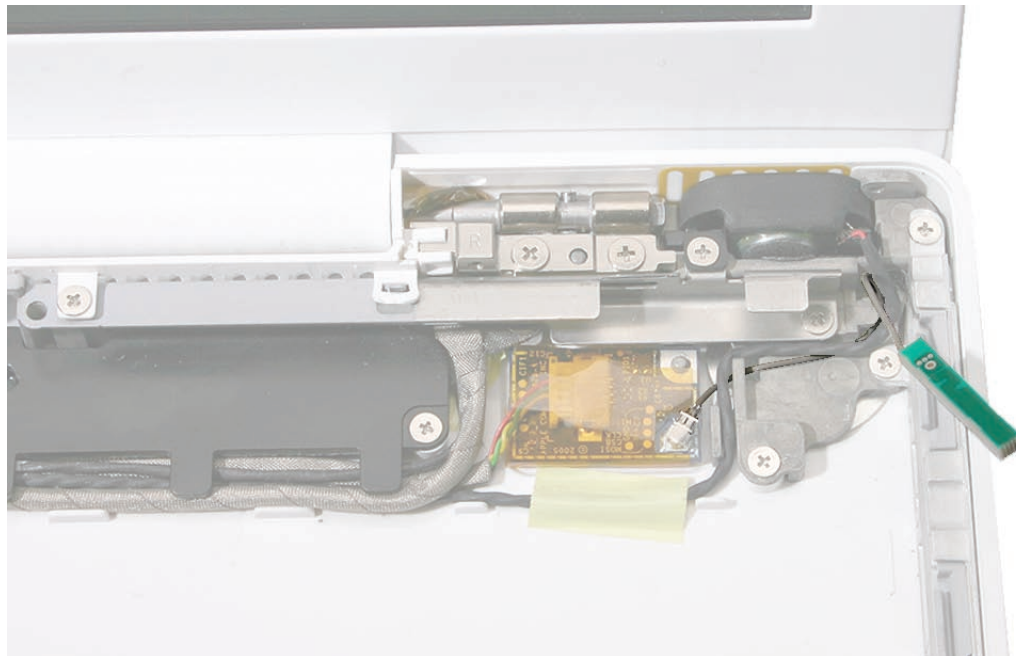

Procedure

1. Remove the 3-mm screw from the right speaker.

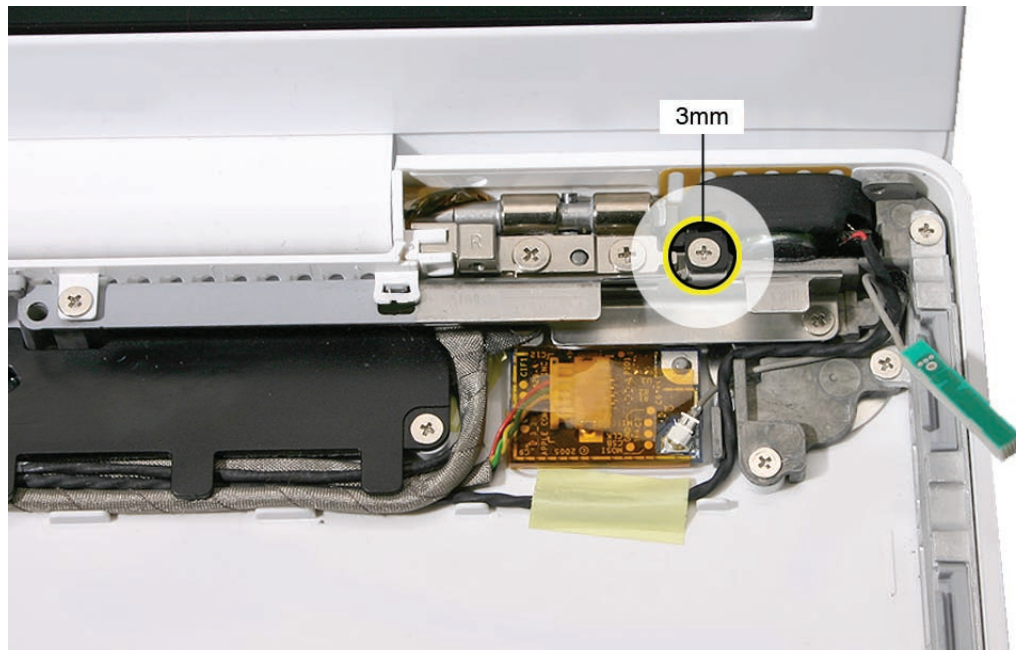

2. Without straining the speaker cable, tilt up the speaker and unroute it from the right corner of the frame.



3. Use a black stick to unroute the Bluetooth and speaker cable.

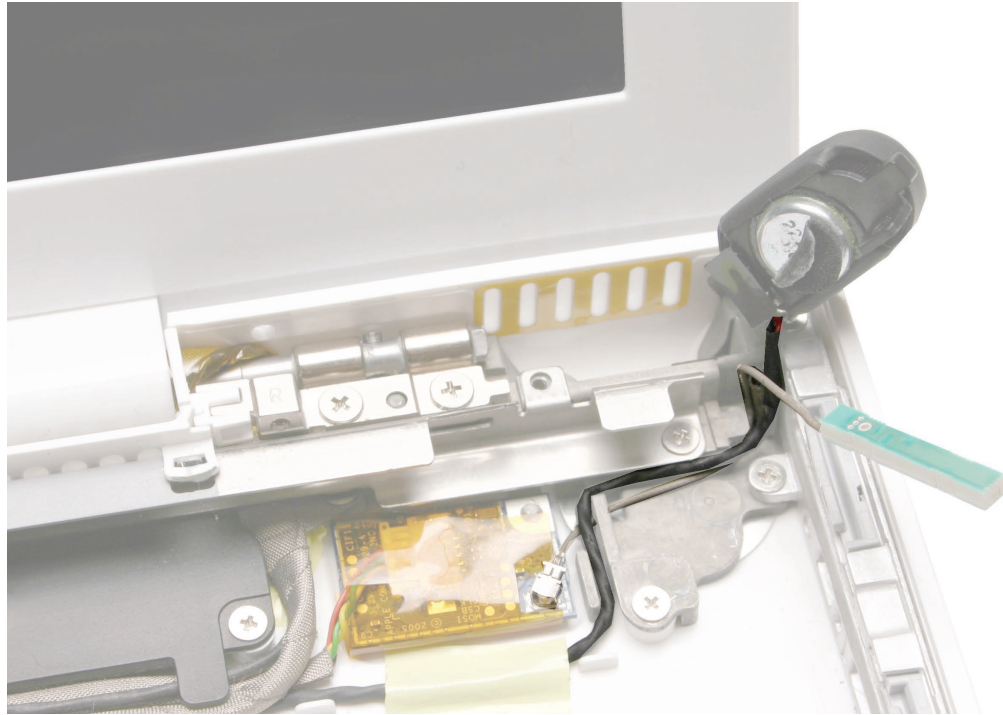

4. Using a black stick, disconnect the Bluetooth antenna cable from the lower right corner of the Bluetooth board. Pry the connector straight up.



5. Install the replacement Bluetooth antenna board and cable.

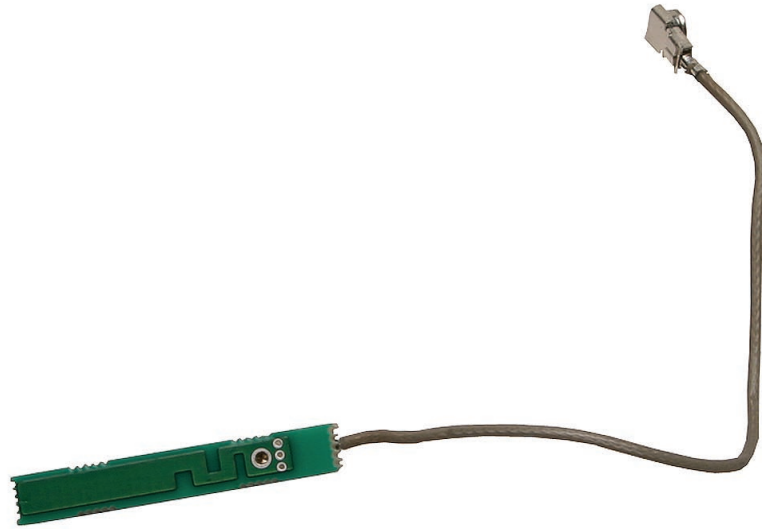

Replacement Caution: To prevent a pinched or damaged cable, the cable might be wrapped with tape, as shown. Do not remove any tape that is wrapped around the cable.

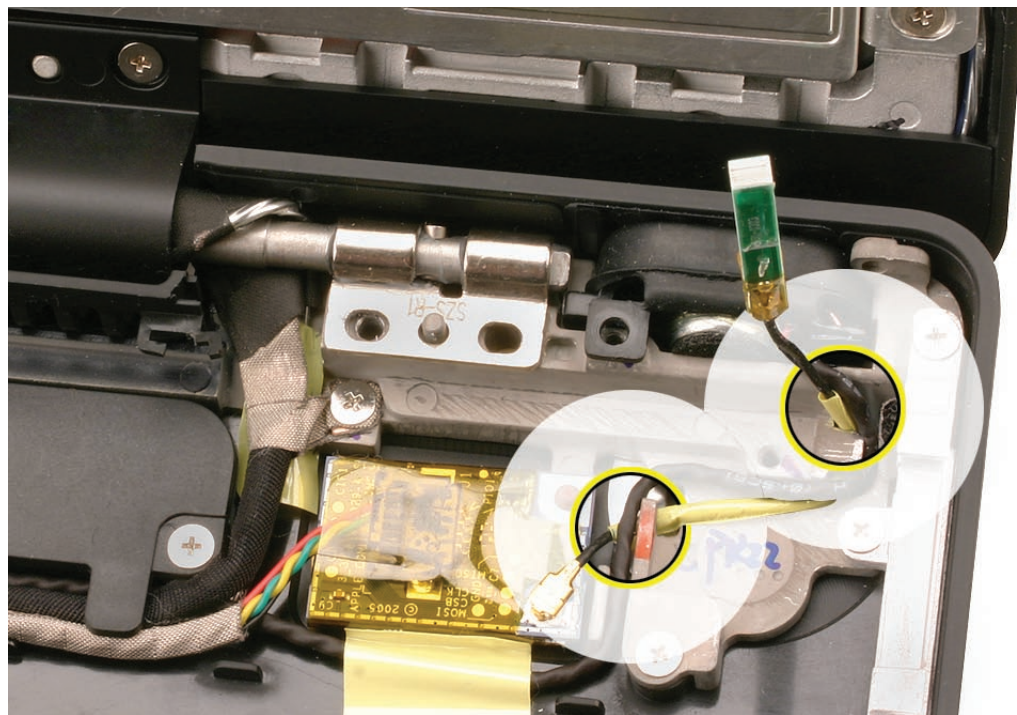



Bluetooth Board

Tools

- ESD wrist strap and mat
- Black stick (Apple part number 922-5065) or other nonconductive nylon or plastic flatblade tool

Preliminary Steps

Before you begin, remove

- Battery
- RAM door
- Top case with keyboard
- Optical drive

Part Location



Procedure

Caution: During this procedure and when applying a replacement Bluetooth board, do not press on the center of the board. The only acceptable area to press on is the right corners of the board near the locator pin and the Bluetooth antenna cable connector.

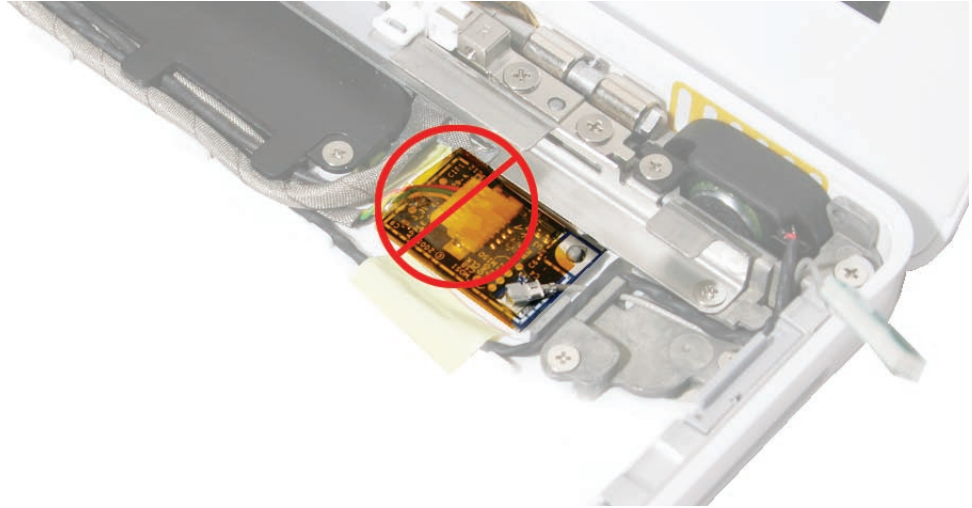

1. **Important:** The Bluetooth board is adhered to the bottom case with double-sided tape. Before removing the Bluetooth board, note the cable routing near the Bluetooth board.
2. Using a black stick, disconnect the Bluetooth antenna cable from the lower right corner of the board. Pry the connector straight up.

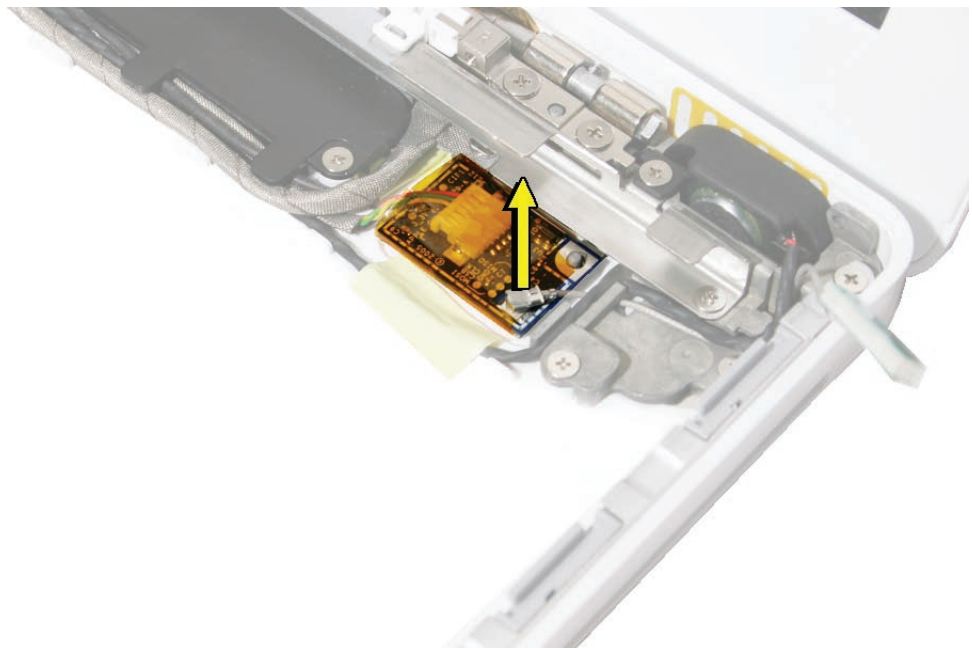

3. Use a black stick at the lower edge of the board to gently loosen the adhesive and lift the board off the bottom case.

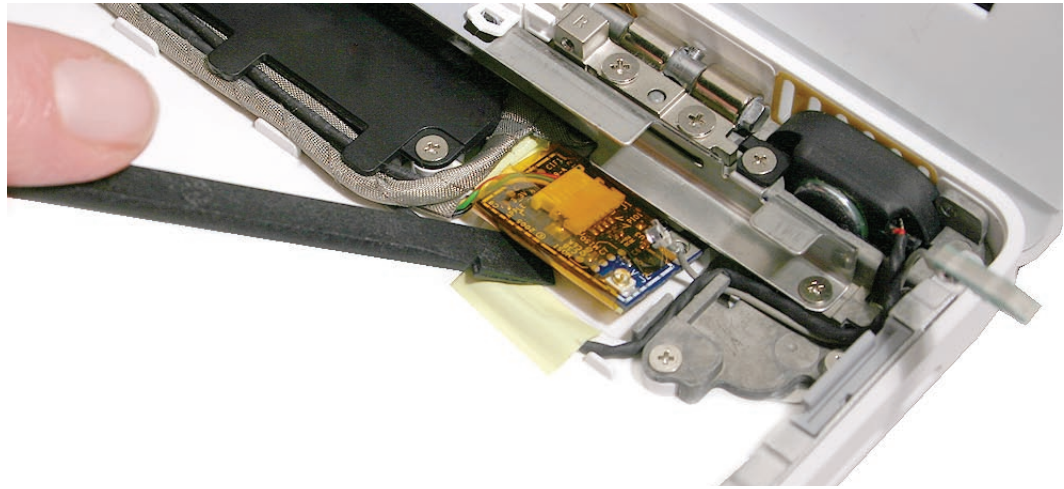

4. Tilt up the board and holding the Bluetooth-to-logic board cable close to the connector, pull the cable to disconnect it from the board.



Replacement Note: Without straining the cable, slide a black stick underneath the board sleeve, and press the connector to secure it to the board.

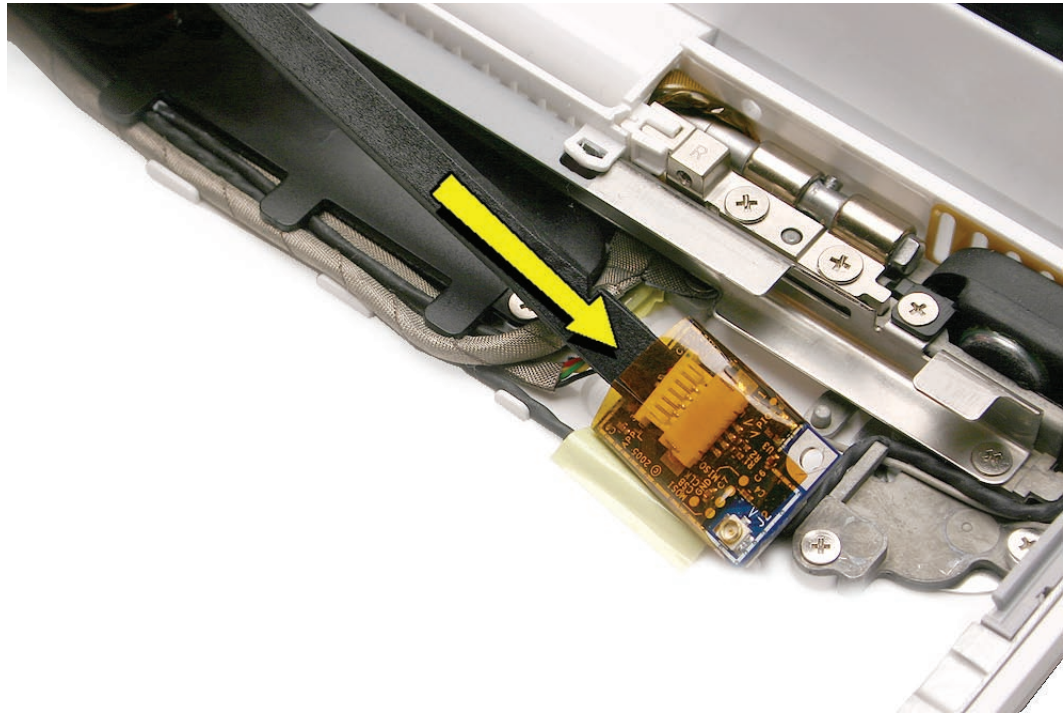

Replacement Note: Connect the Bluetooth-to-logic board cable first before adhering the board to the bottom case. Then install the Bluetooth antenna cable, and make sure the cable exits toward the upper right corner of the bottom case.

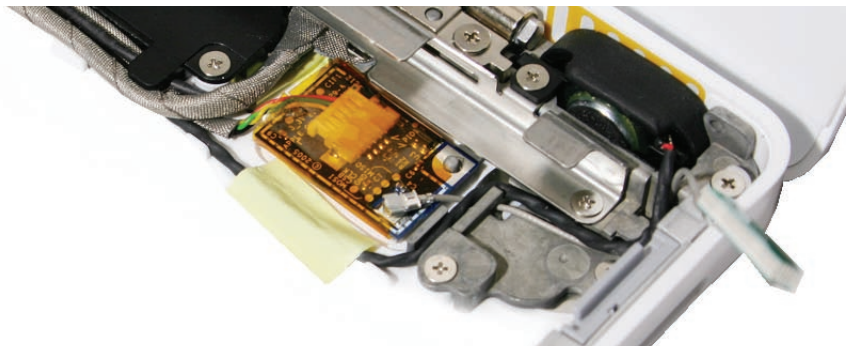

Replacement Note: Make sure the upper right corner of the board fits over the locator pin. To secure the board, press only the right corners of the board near the locator pin and the Bluetooth antenna cable.

5. Install the replacement Bluetooth board, and reassemble and test the computer.

Replacement Note: If installing a new Bluetooth board, remove any remaining adhesive from the bottom case. Then remove the adhesive backing from the new board before installing it in the bottom case.



Bluetooth-to-Logic Board Cable

Tools

- ESD wrist strap and mat
- Black stick (Apple part number 922-5065) or other nonconductive nylon or plastic flatblade tool

Preliminary Steps

Before you begin, remove

- Battery
- RAM door
- Top case with keyboard
- Optical drive
- Bluetooth board

Part Location

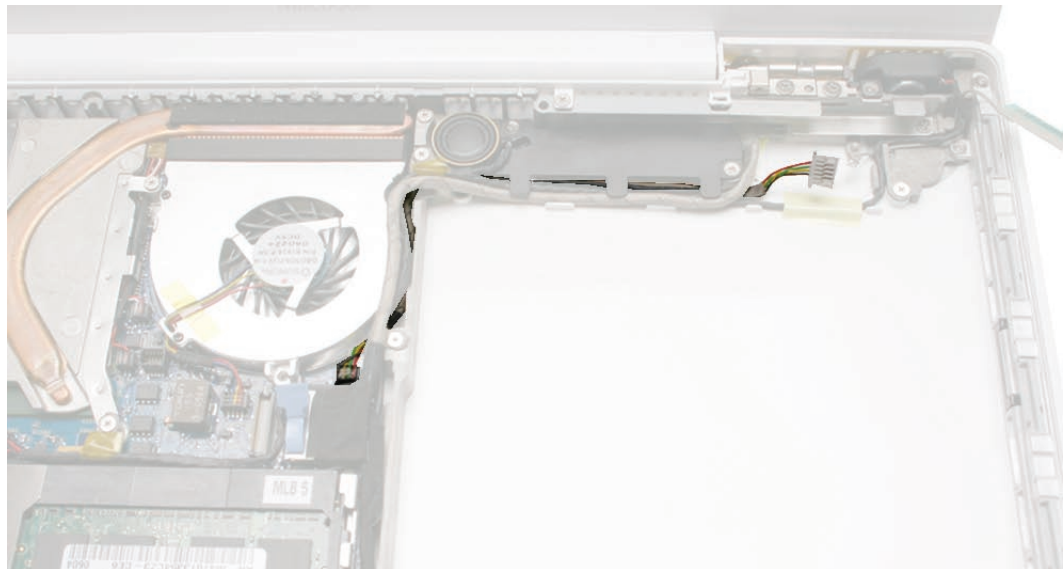

Procedure

Important: During this procedure and when applying a replacement Bluetooth-to-logic board cable, do not press on the center of the Bluetooth board. The only acceptable area to press on is the right corners of the board near the locator pin and the Bluetooth antenna cable.

1. Remove the following screws:
 - 7.5-mm long ground screw from the midframe
 - 3-mm long subwoofer screw from the bottom corner of the subwoofer

Warning: The subwoofer cone is a sensitive device. Avoid touching the subwoofer cone.

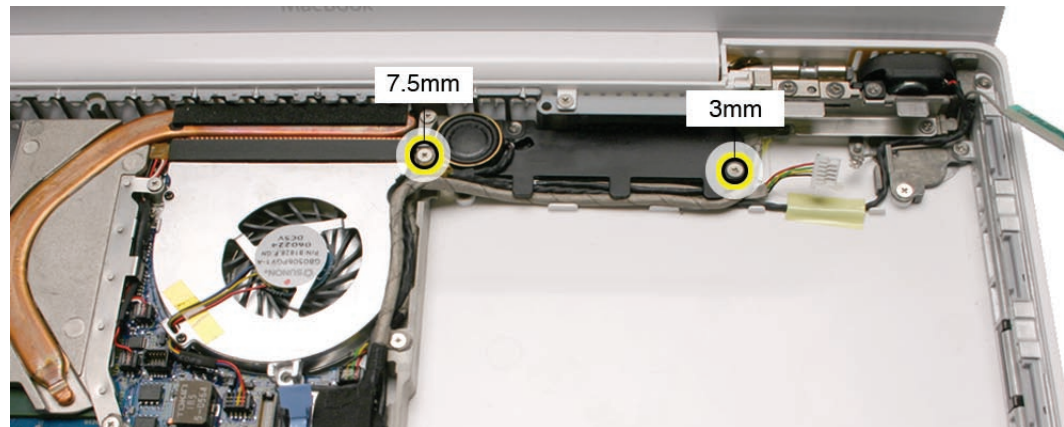

2. Carefully lift up the cables from the ground tab area.

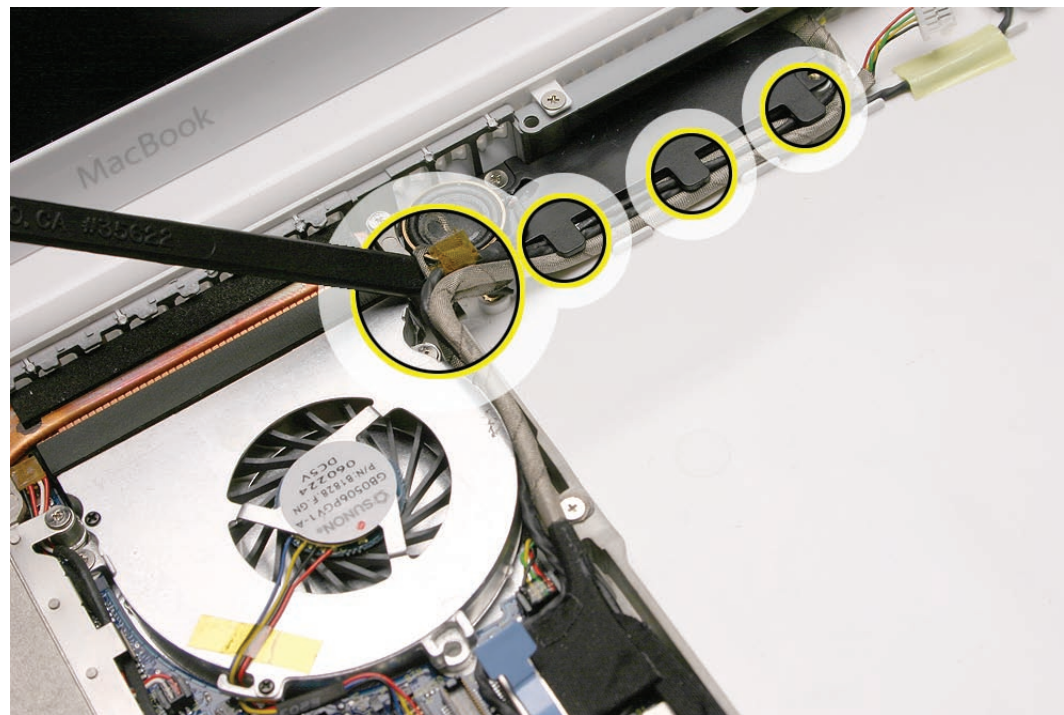

3. With the Bluetooth cable disconnected from the Bluetooth board, use a black stick to carefully separate the cable from the other cables routed along the bottom edge of the subwoofer (microphone cable, LVDS cable, speaker/subwoofer cable.)

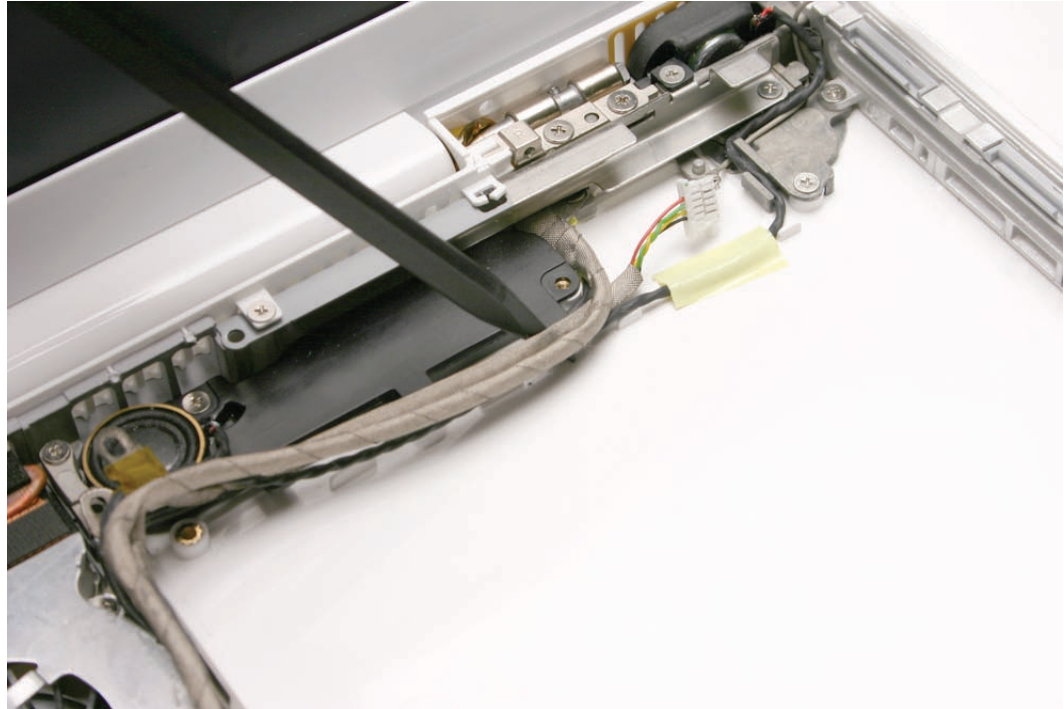

4. Thread the cable out from under the LVDS cable and speaker cable.



5. Use a black stick close to the Bluetooth cable connector to disconnect it from the corner of the logic board. (Pull the cable straight up.)

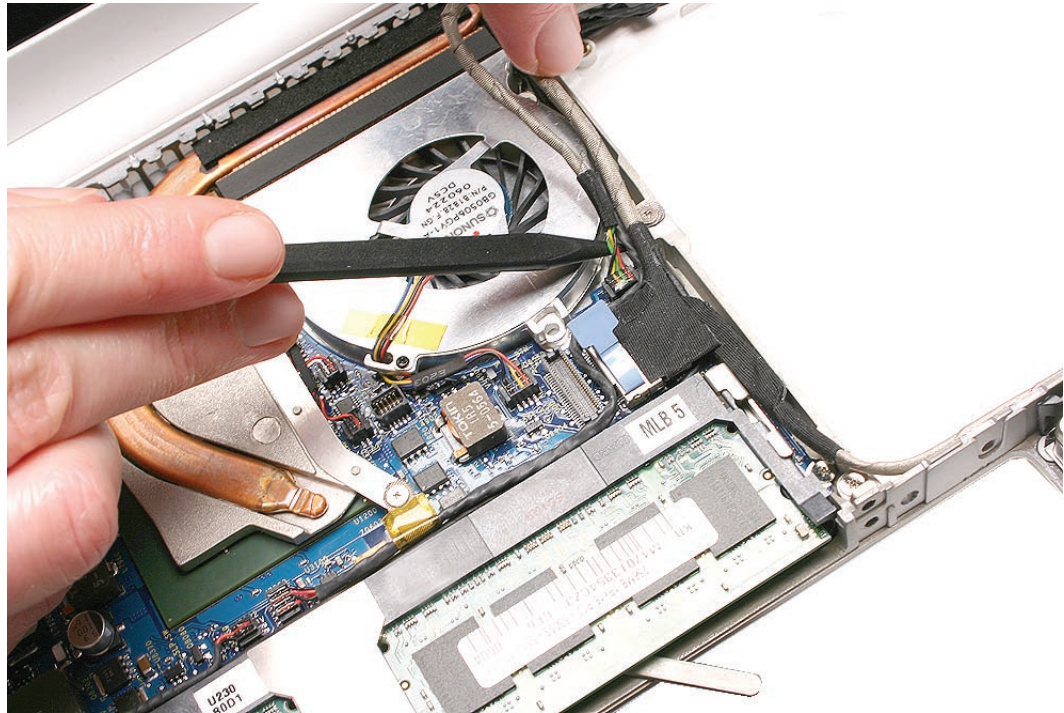

Replacement Note: Connect the Bluetooth board cable first before adhering the Bluetooth board to the bottom case. Make sure the cable routing appears as shown.

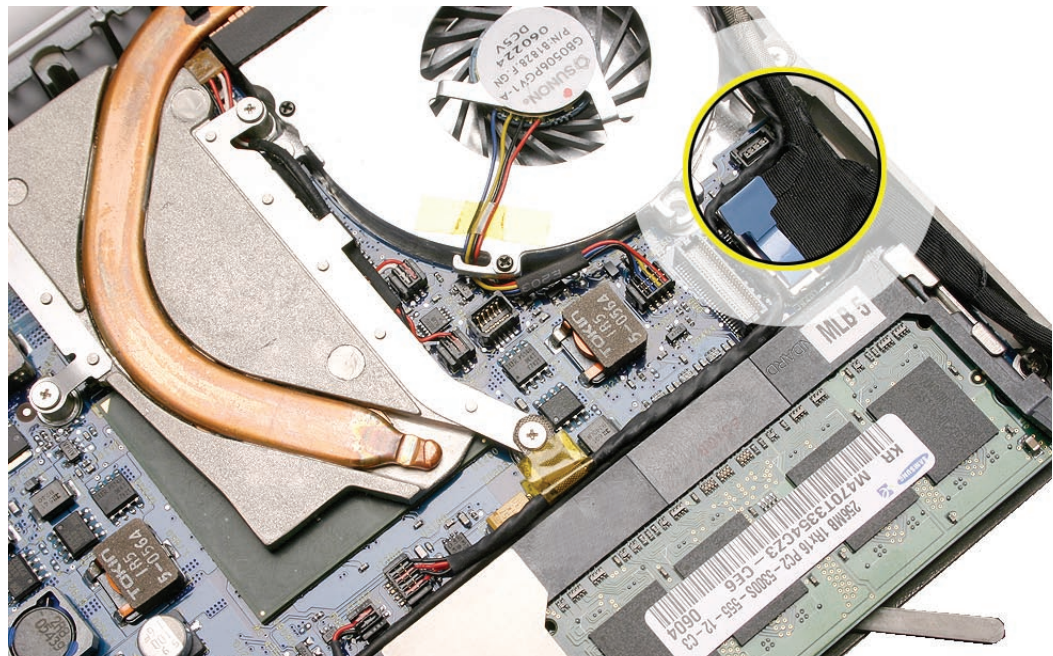

-
6. Install a replacement Bluetooth-to-logic board cable, and reassemble and test the computer.



Replacement Note: With the cable attached to the Bluetooth board, install the cable under the subwoofer tabs before routing the cable to the logic board.

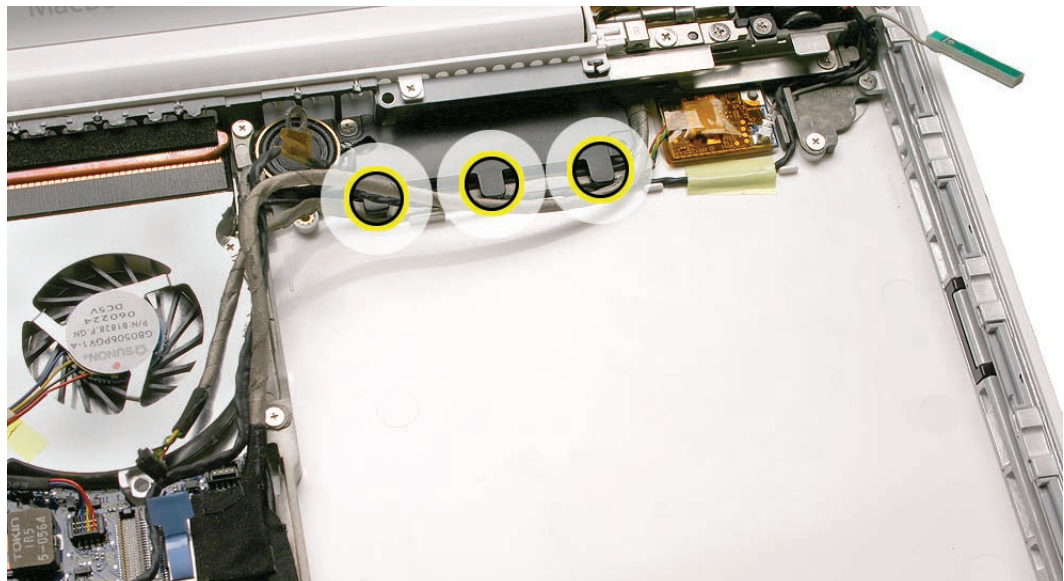



Subwoofer with Right Speaker Cable

Tools

- ESD wrist strap and mat
- Magnetic Phillips #0 screwdriver
- Black stick (Apple part number 922-5065) or other nonconductive nylon or plastic flatblade tool

Preliminary Steps

Before you begin, remove

- Battery
- RAM door
- Top case with keyboard
- Optical drive

Part Location

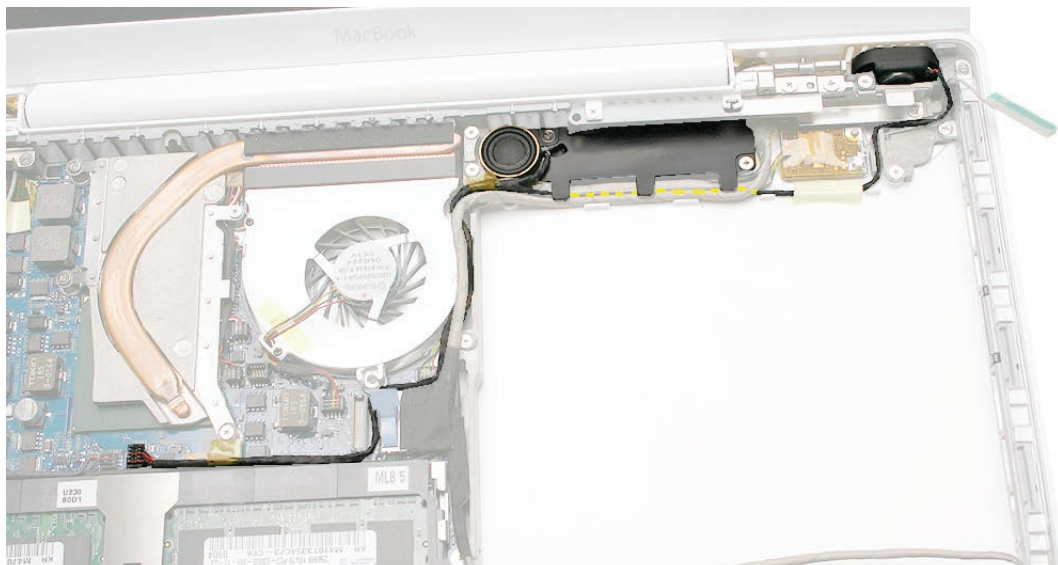

Procedure

Warning: The subwoofer cone is a sensitive device. Avoid touching the subwoofer cone.

1. Note the cable routing for the right speaker and the subwoofer.

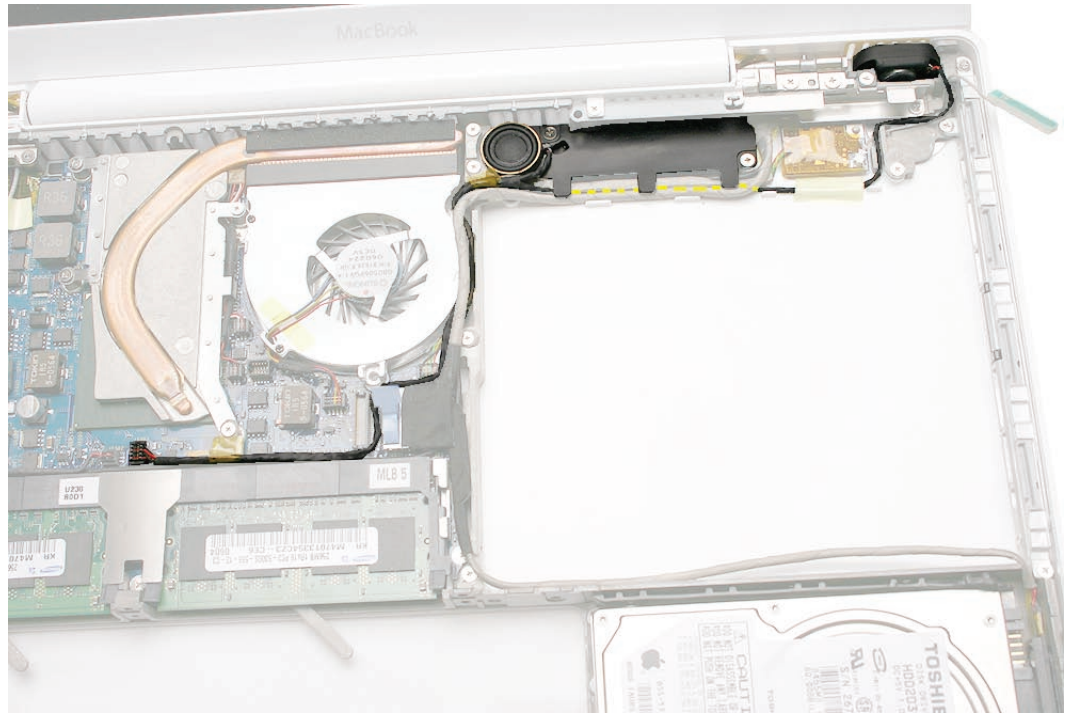

2. Remove the following screws:
 - Two 3-mm long screws from the opposite corners of the subwoofer body
 - 3-mm long screw from the right speaker.

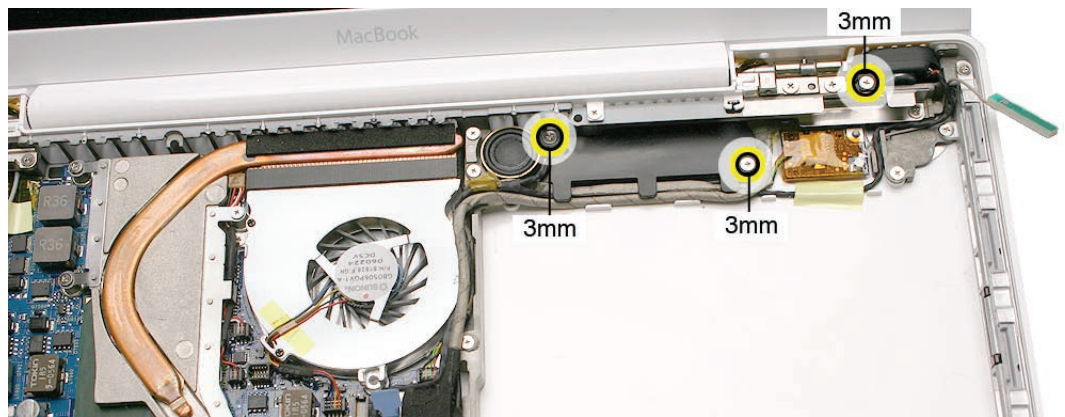

3. Tilt up the right speaker from the top right corner of the computer assembly, and without straining the speaker cable, unroute it from the cable guides.
4. Peel up the tape.

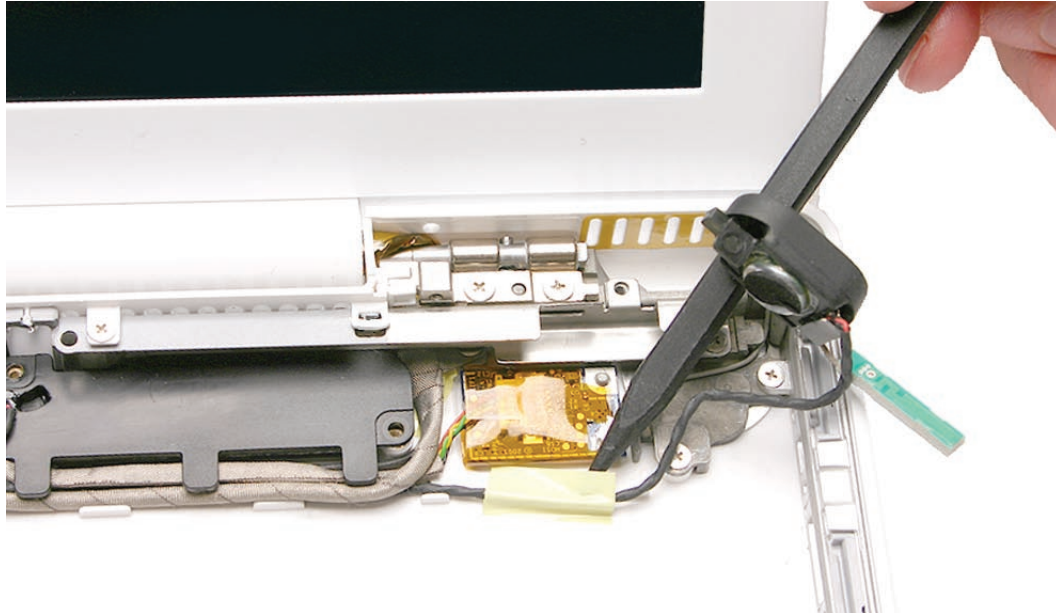

5. Remove the 7.5-mm long top ground screw from the midframe.



- 6. Warning:** The subwoofer cone is a sensitive device. Avoid touching the subwoofer cone. To prevent excessive pressure on the subwoofer body, hold it by the edges as you perform this step.

Unroute the speaker cable, and while holding the sides of the subwoofer, move the subwoofer body away from the rear panel.

- 7.** Disconnect the 4-pin speaker cable from the logic board connector, just over the memory card slots.

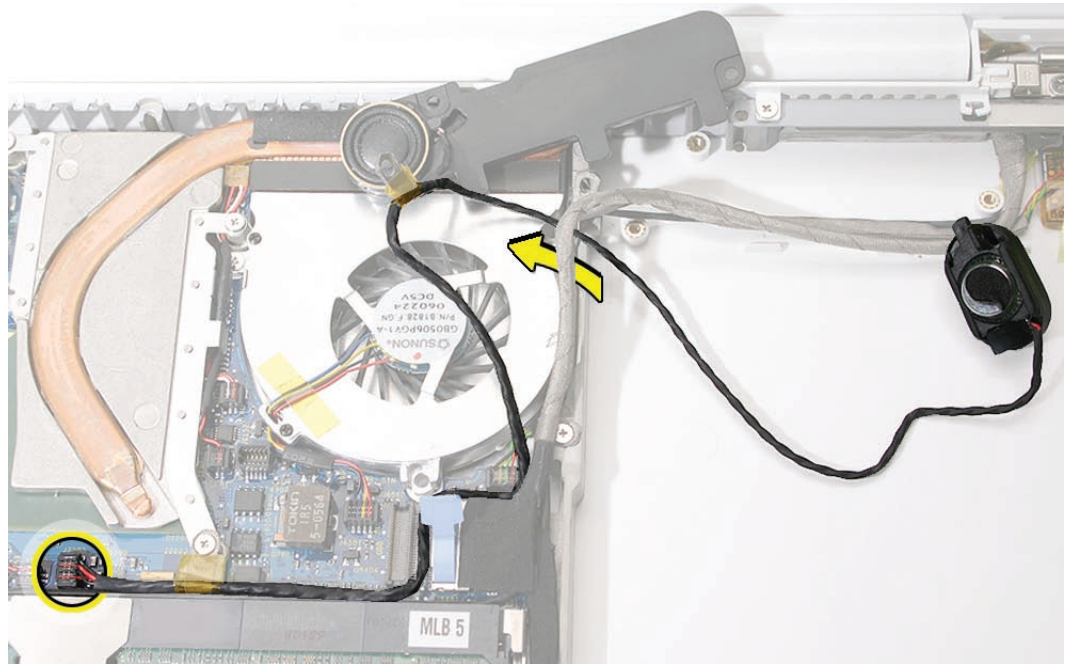

- 8.** Remove the 8-mm long ground screw from the lower end of the heatsink.

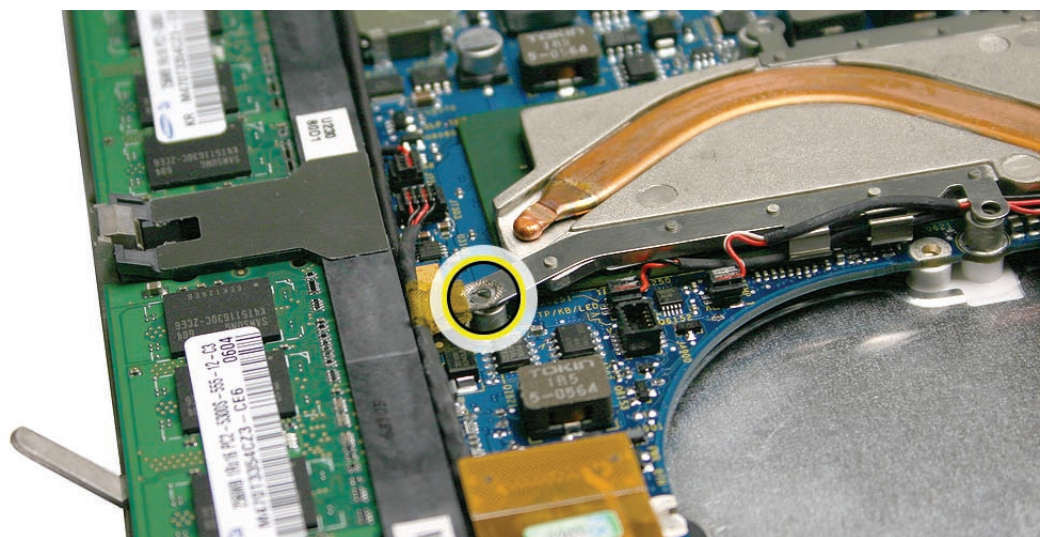

Replacement Note: When connecting the right speaker cable to the logic board, make sure the cable runs securely

- over the right memory slot
- between the optical drive cable connector and the LVDS cable connector
- under the Bluetooth connector
- between the fan and the midframe, and is anchored to the top of the midframe with a mesh tab

Replacement Note: Before installing the subwoofer, check the bottom case to make sure the microphone cable is to the right of the LVDS cable, between the LVDS cable and the Bluetooth board.

Replacement Note: Before securing the subwoofer screws, place the subwoofer into the bottom case, but tilt it up slightly to tuck these cables under the subwoofer tabs and above the raised tabs on the bottom case:

- Microphone cable first
- Bluetooth cable second
- Speaker cable third
- LVDS cable fourth
- no cables obscure the subwoofer screw posts on the bottom case
- the right speaker cable is routed correctly in the right corner of the bottom case and is taped where shown.

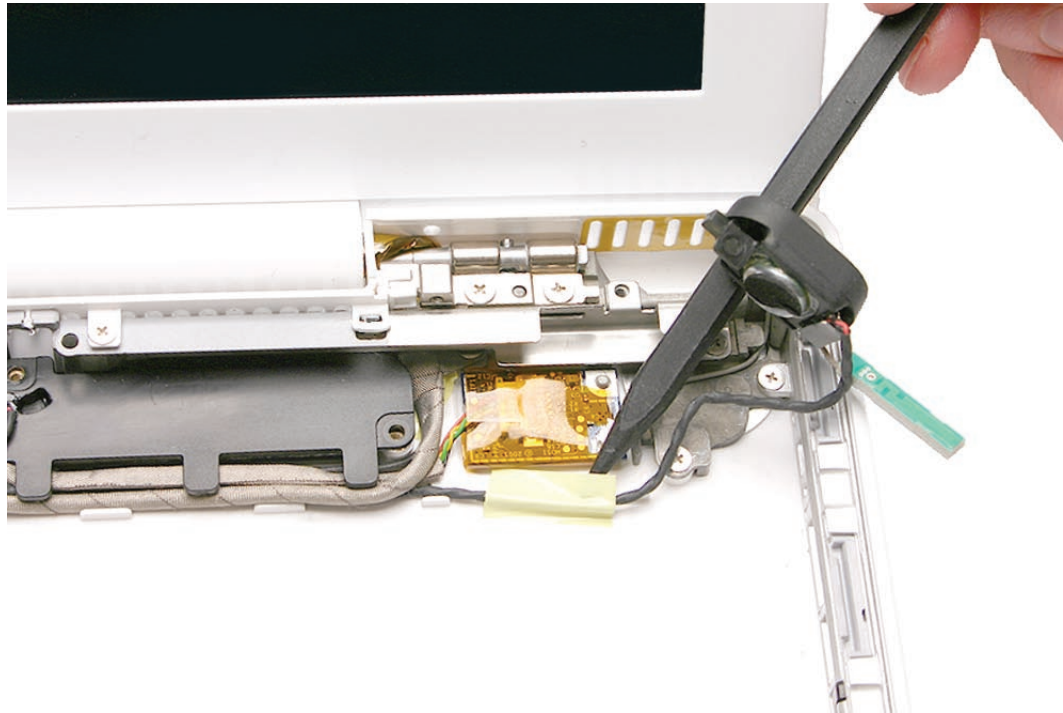

Replacement Note: Install the subwoofer screws only when you are sure that the cables cannot be pinched and are in the orientation specified. After the subwoofer screws are installed, install the grounding screws and tabs on the midframe

-
9. Install the replacement subwoofer with right speaker cable, and reassemble and test the computer.



Procedure

1. Note the orientation of the cables that route over and to the left of the midframe.

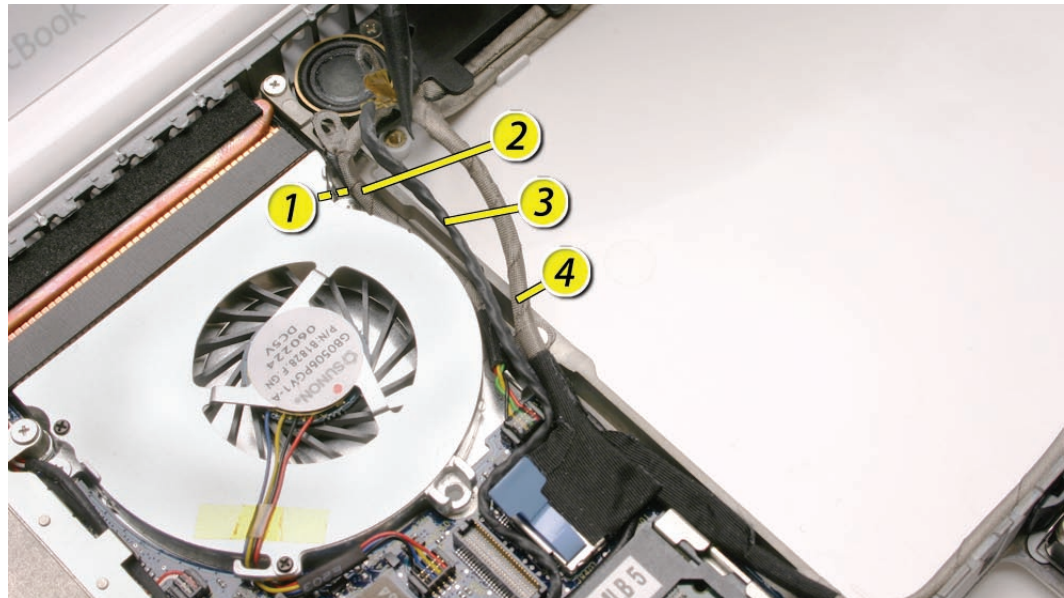

2. Remove the two ground screws:
 - 9-mm long screw from the center of the midframe
 - 7.5-mm long screw near the top of the midframe, next to the subwoofer**Warning:** The subwoofer cone is a sensitive device. Avoid touching the subwoofer cone.
3. Disconnect the LVDS cable by pulling the pull-tab straight up.

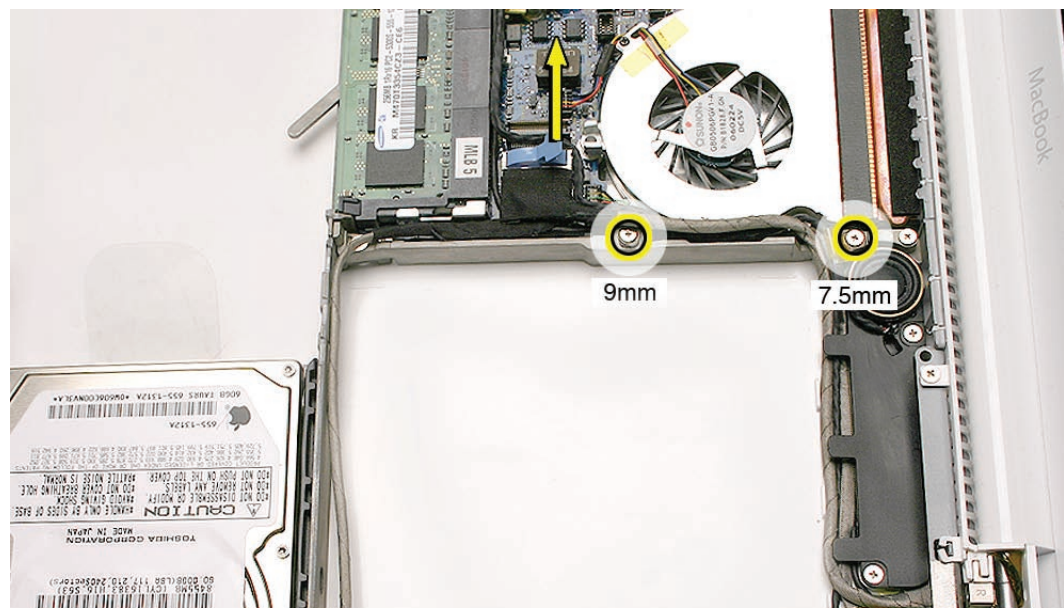

4. Move aside the LVDS cable and the hard drive connector cable.
5. Remove the two screws from the ends of the midframe:
 - 7.5-mm long screw at the top
 - 6-mm long screw at the bottom

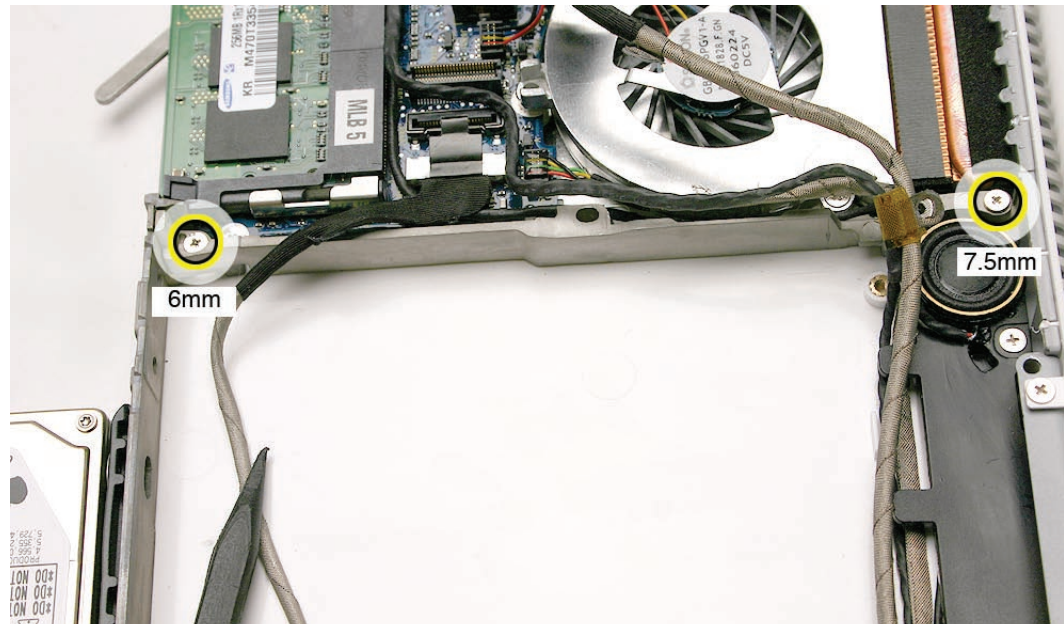

6. Without straining the cables between the frame and the midframe, lift them out to reach the 3-mm long fan screw.

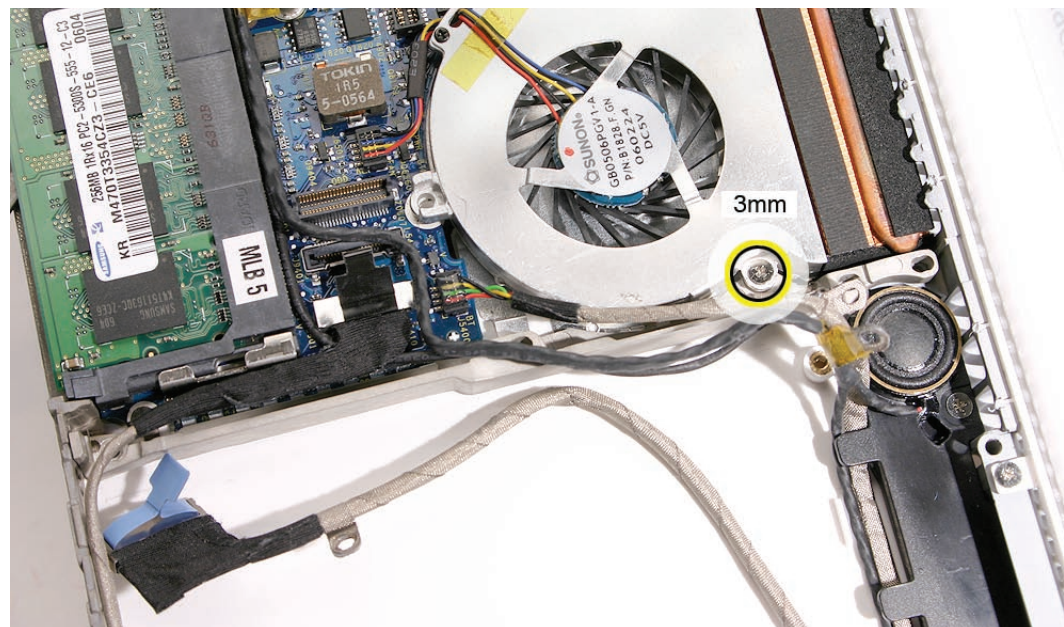

7. Being careful not to strain any nearby cables or components, tilt out the lower end of the midframe, and remove the midframe from the bottom case.

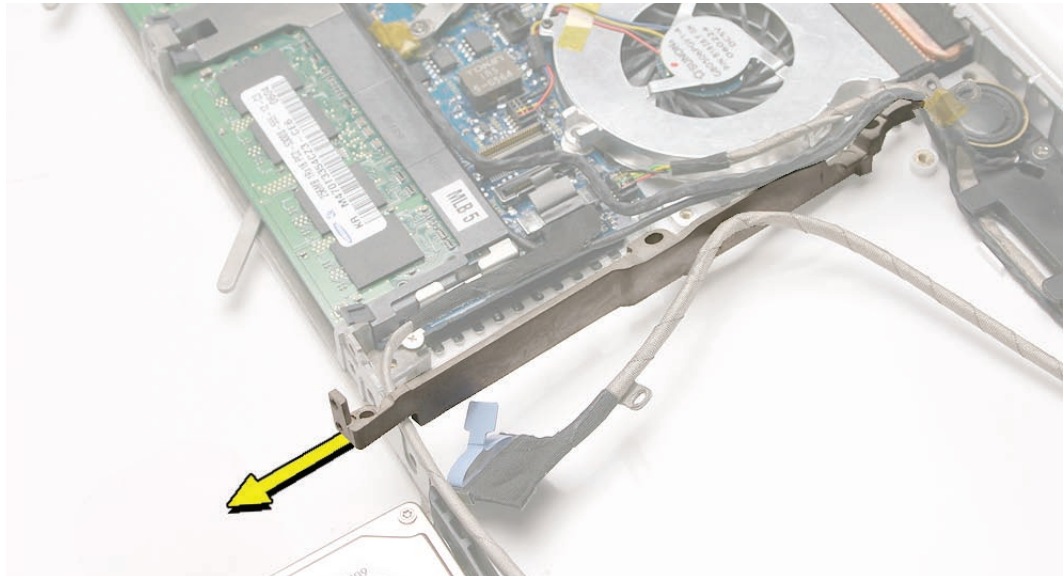

Replacement Note: When tucking in the cables into the channel between the fan and the midframe, be sure to install them in this order:

- Microphone cable first
- Bluetooth cable second
- Speaker cable third
- LVDS cable fourth

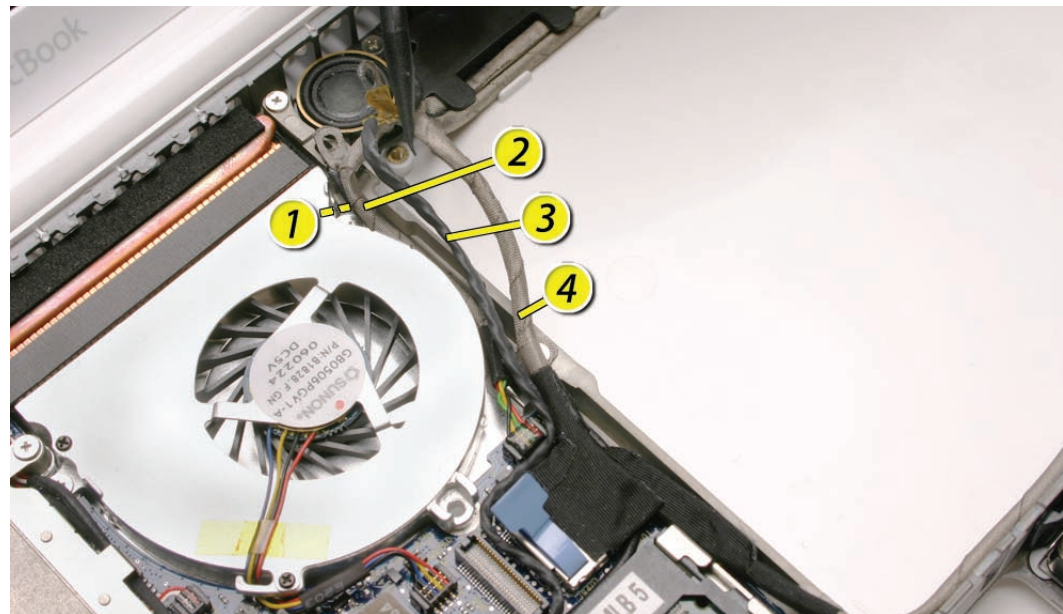

-
8. Install the replacement midframe, and reassemble and test the computer.





Display Bezel

Tools

- ESD wrist strap and mat
- Black stick (Apple part number 922-5065) or other nonconductive nylon or plastic flatblade tool
- Access card (Apple part number 922-7172)

Preliminary Steps

Before you begin, remove

- Battery
- RAM door
- Top case with keyboard

Part Location



Removal Procedure

1. With the display open wider than a 90-degree angle, run an access card along the outer sides and top edge of the bezel where it meets the display rear housing.



Note: When opening the bezel, you might find that a small dot of adhesive is used at the top corner:

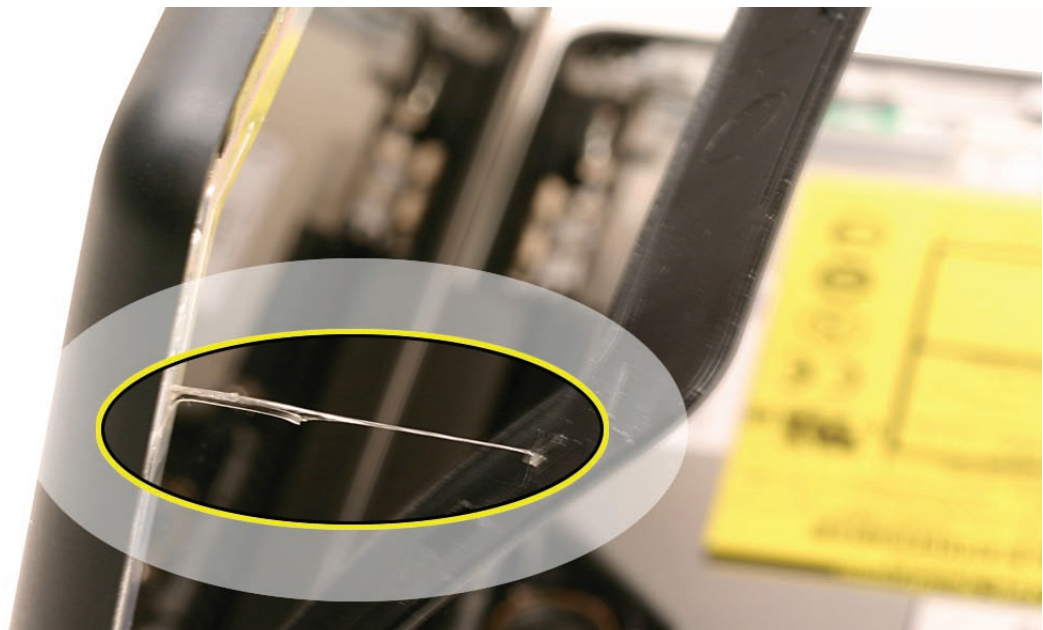

2. To loosen the bottom of the bezel, run a black stick along the inner edge where the bezel meets the LCD frame. Do not touch the display face.



Note: If you have a plastic sheet that can protect the LCD panel, cover the display face.

3. Lift off the bezel.
4. Check for any mounting clips around the LCD frame that pop off or appear to be missing.



- Return any clips back into the bezel brace.

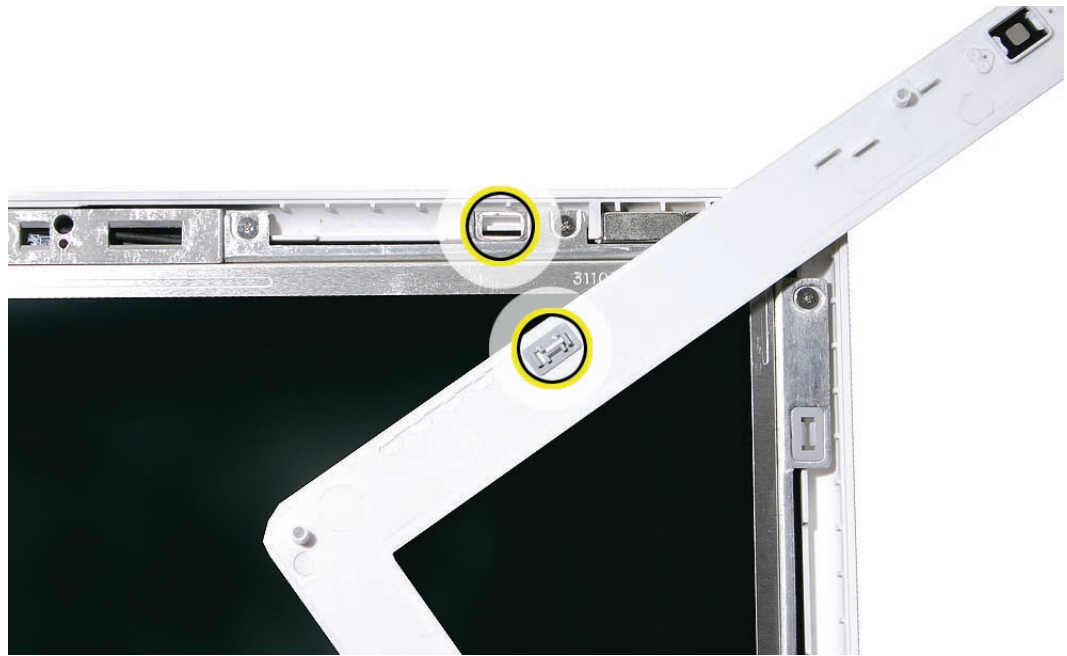

- If any of the mounting clips are difficult to install, check that they are structurally sound. You can order a kit of replacement clips if necessary.

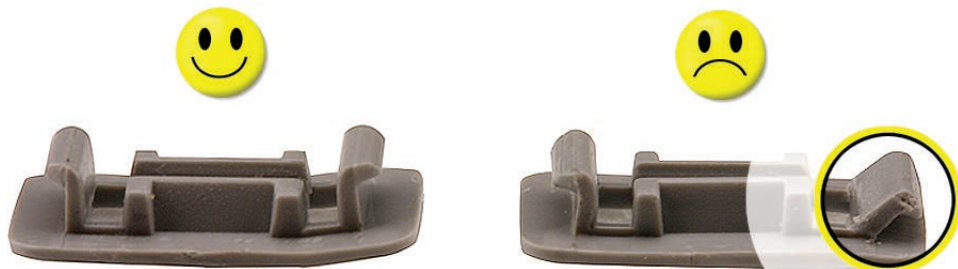

- Install the replacement bezel (first see notes in the Replacement Procedure), and reassemble and test the computer.

Replacement Procedure

Important: Before installing a replacement bezel, be sure to check the camera area, and peel off the dust cover film that comes with a new bezel.

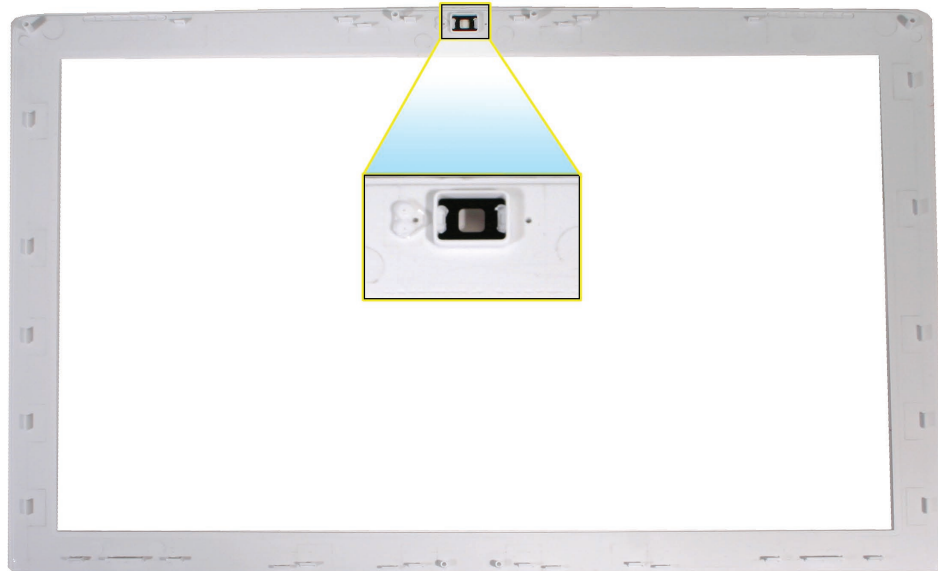

Replacement Caution: The lower corners of the bezel include mounting hooks that differ in design from the snaps at the top and sides of the bezel. Incorrectly installing this area of the bezel can result in bent hooks and a bezel gap that would require bezel replacement. These hooks must be installed as follows.

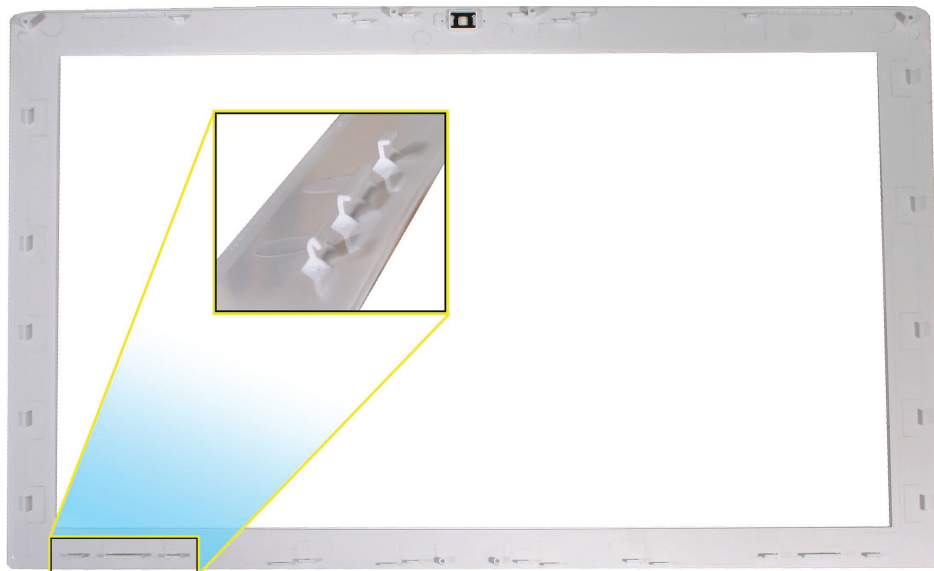

-
1. **Caution:** To install the bezel, start at the top near the camera first. Match the two locator pins inside the bezel to the holes in the top center of the display assembly.

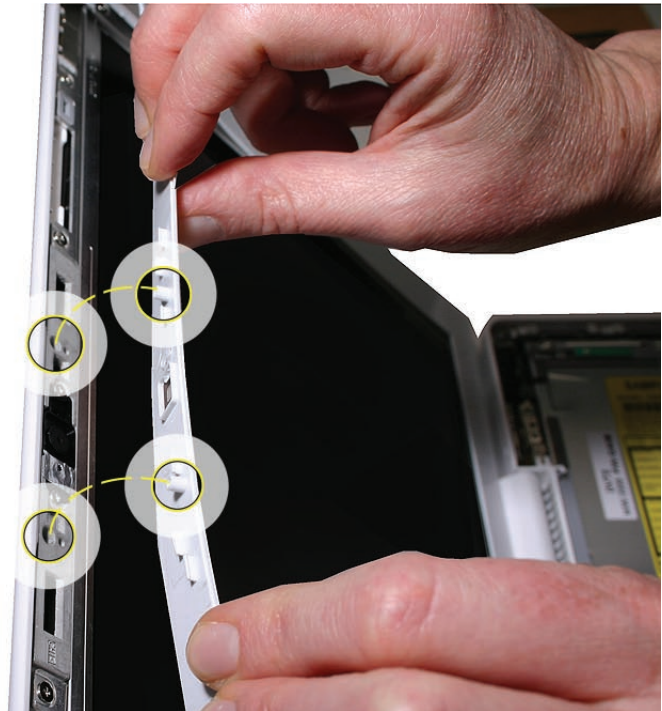

2. Press to secure the top of the bezel.

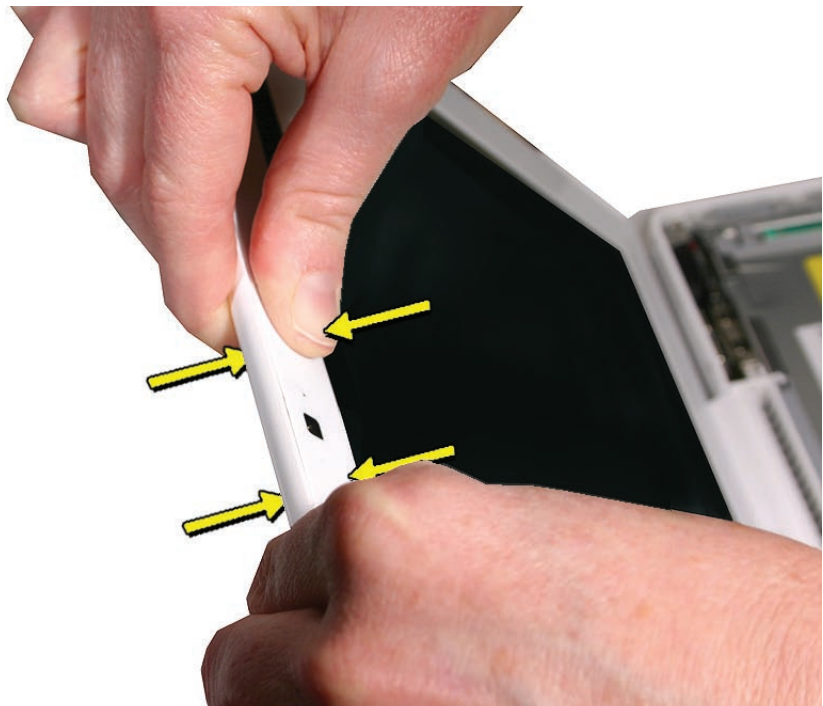

-
3. With the camera area secured, bend up the bottom of the bezel to hook the bottom edge of the bezel.



4. Press along the outer frame of the bezel to secure it to the display assembly.



Spacers at Bezel Scoops

Tools

- Soft cloth
- ESD wrist strap and mat
- Black stick (Apple part number 922-5065) or other nonconductive nylon or plastic flatblade tool

Preliminary Steps

Before you begin, remove

- Battery
- RAM door
- Top case with keyboard
- Display bezel

Part Location

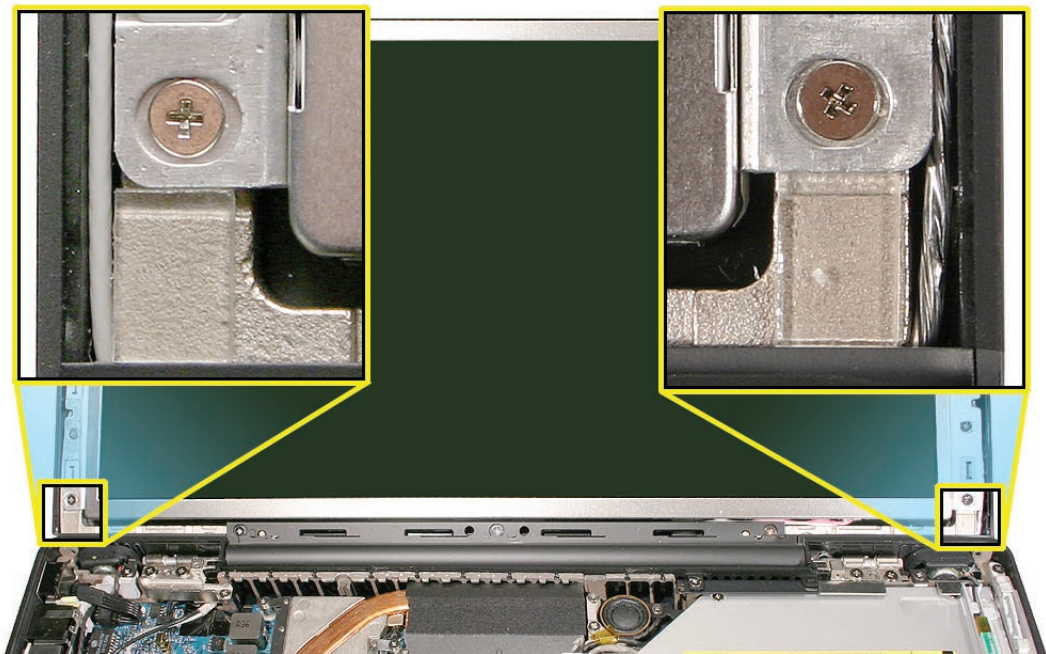

Procedure

1. Note the placement of the two spacers that attach to the LCD panel frame with double-sided adhesive.

Replacement Note: Position the replacement spacers vertically so that they fit into the space between the lower end of the bezel brace and the bezel scoop, but they should not extend past the outer edge of the display hinge.

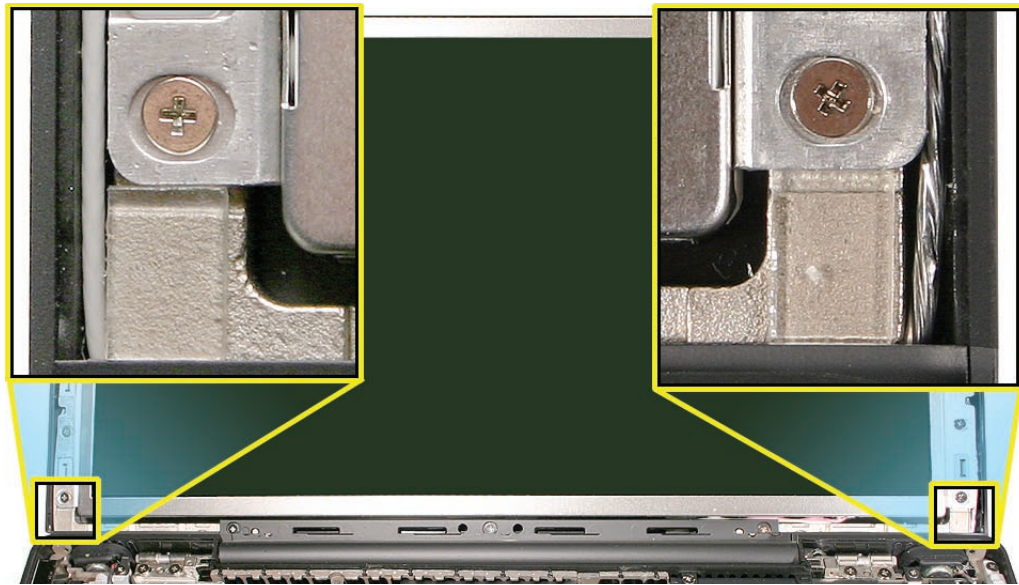

2. Using a black stick, remove the spacers.

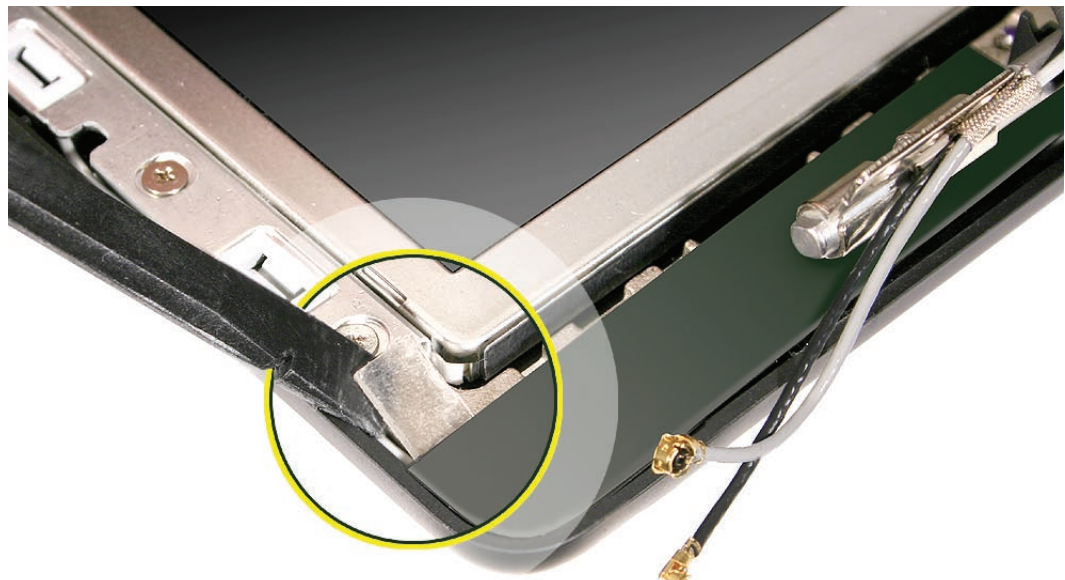

3. Install the replacement spacers above the bezel scoops, and reassemble and test the computer.



C-Channel

Tools

- ESD wrist strap and mat
- Black stick (Apple part number 922-5065) or other nonconductive nylon or plastic flatblade tool
- Magnetic Phillips #0 screwdriver
- Jeweler's flatblade screwdriver

Preliminary Steps

Before you begin, remove

- Battery
- RAM door
- Top case with keyboard
- Optical drive

Part Location

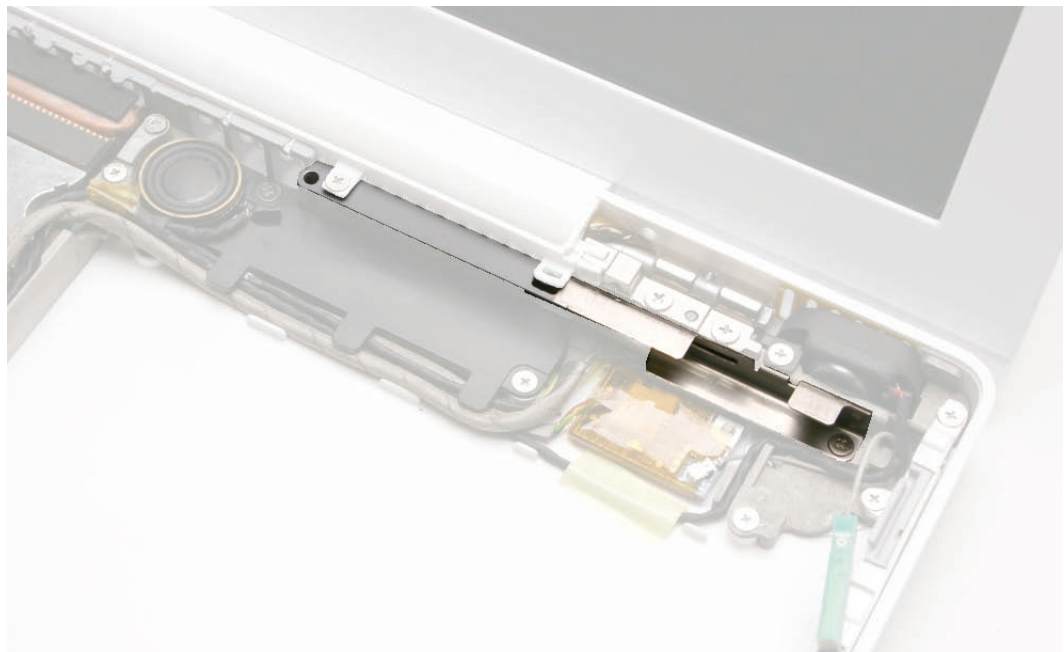

Procedure

1. At the top right corner of the computer assembly, remove the following screws:
 - 6-mm long screw from the left end of the C-channel, securing the vent cover to the C-channel and rear panel
 - 3-mm long screw from the right speaker (the “holder” for the speaker is sandwiched between the screw head and the C-channel)
 - 3-mm long screw from the right end of the C-channel

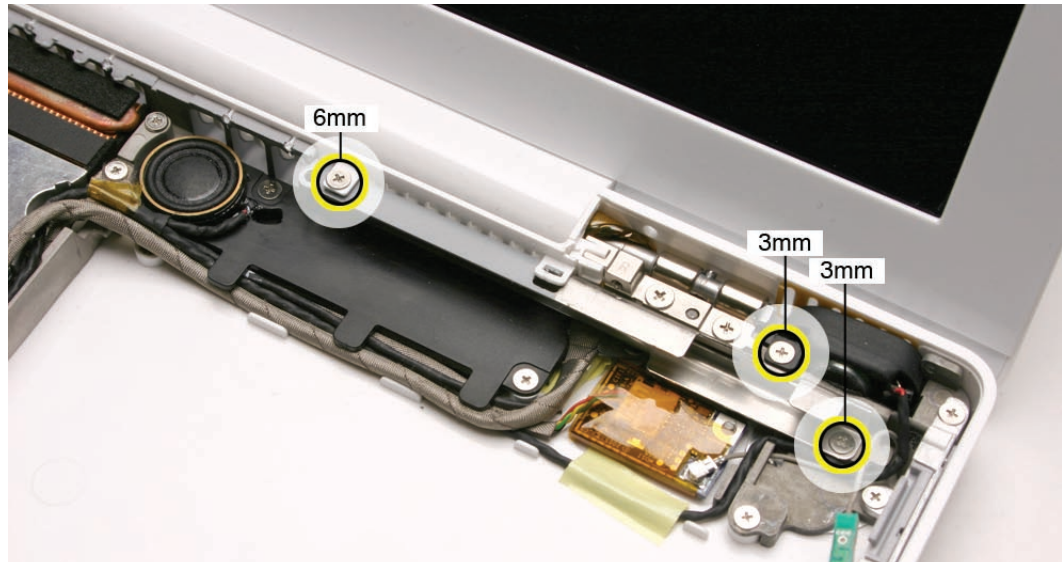

2. Use a black stick to tilt up the right speaker.



3. Note that the C-channel has a locator tab that fits into the slot in the vent cover.
4. Wedge a black stick between the right clutch block and the C-channel. Then, at the vent cover slot, use a jeweler's flatblade screwdriver or your fingernail to lightly tilt up the slot as you pivot the C-channel forward and out of the bottom case.

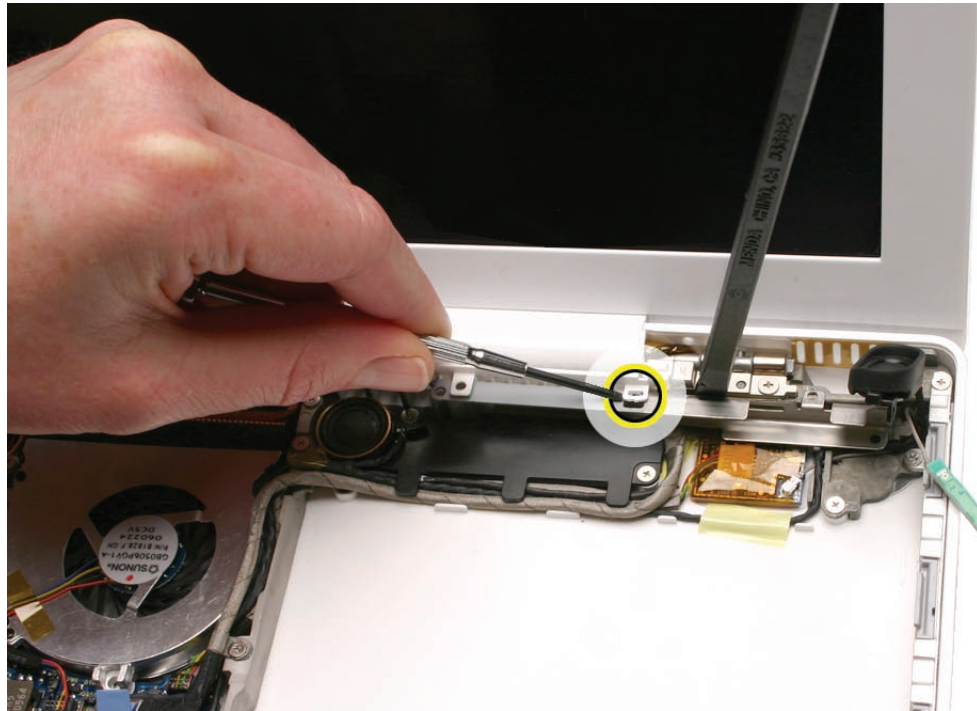

Replacement Note: Tip the left end of the C-channel in first. Then slide the channel under the vent cover slot and into the bottom case so that all three screw holes align.



Replacement Caution: Before installing the screws, make sure the speaker cable is clear of the screw hole.

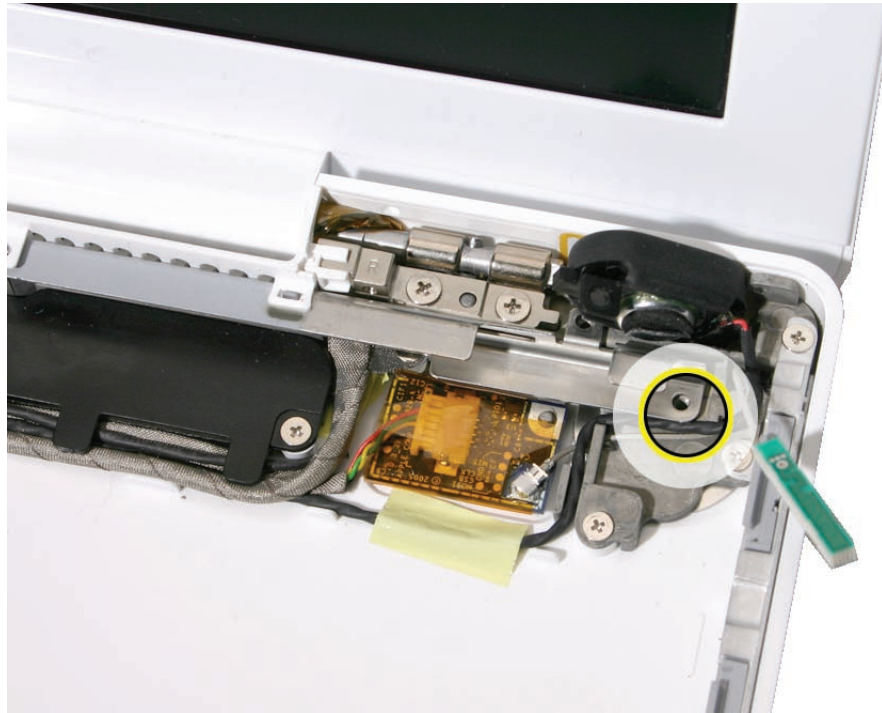

5. Install the replacement C-channel, and reassemble and test the display.





Clutch Block, Left

Tools

- ESD wrist strap and mat
- Black stick (Apple part number 922-5065) or other nonconductive nylon or plastic flatblade tool
- Magnetic Phillips #0 screwdriver
- Stack of books, weighted boxes, or other means of support for display while removing screws from hinge

Preliminary Steps

Before you begin, remove

- Battery
- RAM door
- Top case with keyboard
- Optical drive

Part Location

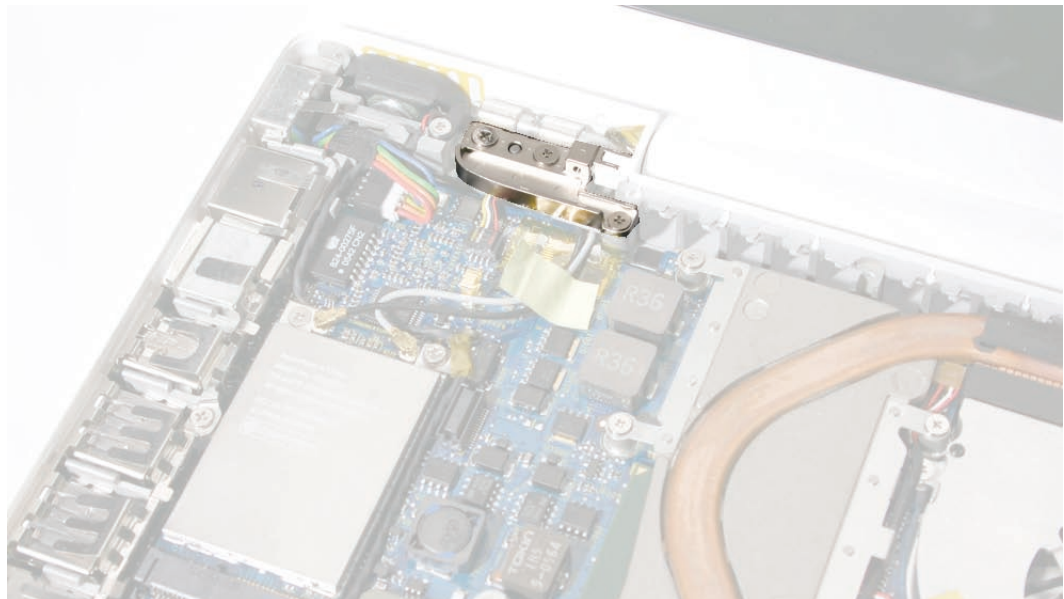

Procedure

1. Open the display and lean it against a stack of books or boxes that can support it when it is loosened from the display hinge.



2. Remove the screws from the left clutch block:
 - 10-mm long thick-stemmed outer screw, closest to the left corner of the bottom case
 - 6-mm long thick-stemmed middle screw
 - 6-mm long thin-stemmed inner screw, closest to the wireless cables.

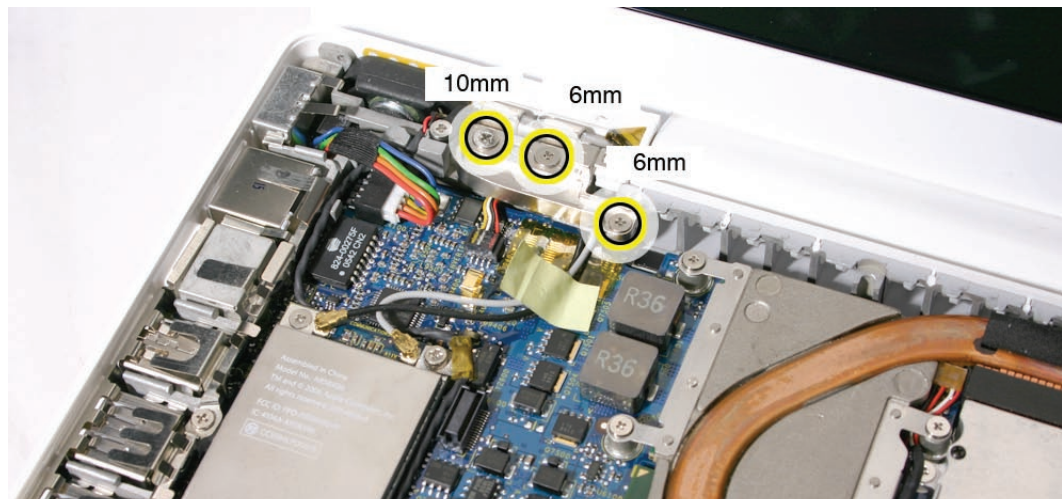

3. Remove the left clutch block from the computer assembly.

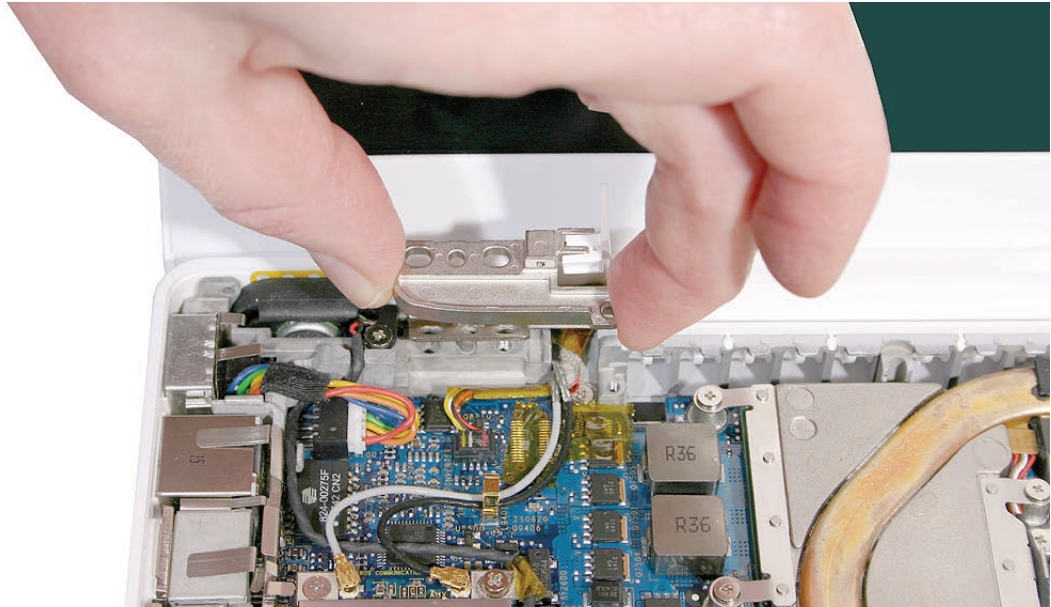

4. Notice that the left clutch cap comes loose when the clutch block is removed. Make sure the left clutch cap is fitted into the clutch block, and hold it in place when replacing the clutch block.



5. If you are installing a new left clutch block, make sure there is a mesh pad on the flip side. This pad protects the cables that run under the left clutch block.

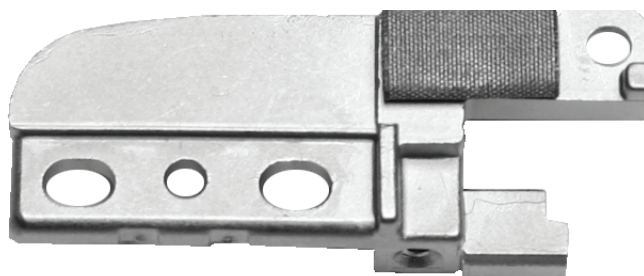

Replacement Note: Notice how the inverter cable and wireless antenna cables are routed around the left display hinge. Make sure they are routed as shown and cannot be pinched when the clutch cap and clutch block are installed.

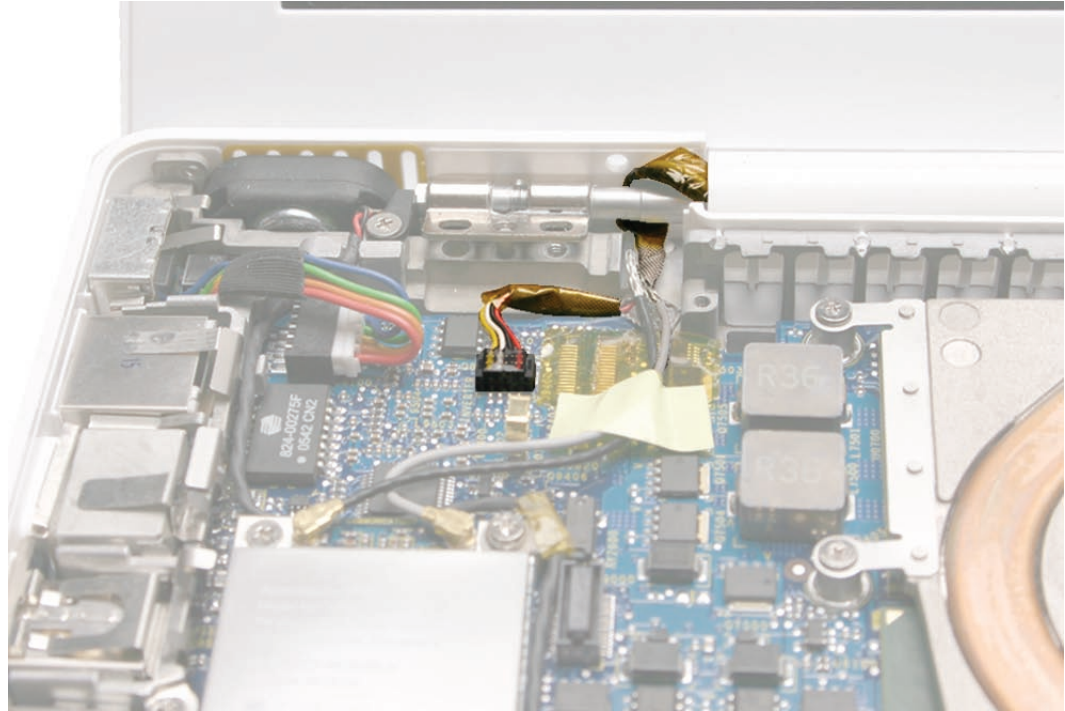

Late 2006 Model:



Late 2006 Model Replacement Caution: If the inverter cable and antenna cables are not routed correctly, they can damage the delicate logic board components located beneath the tape:

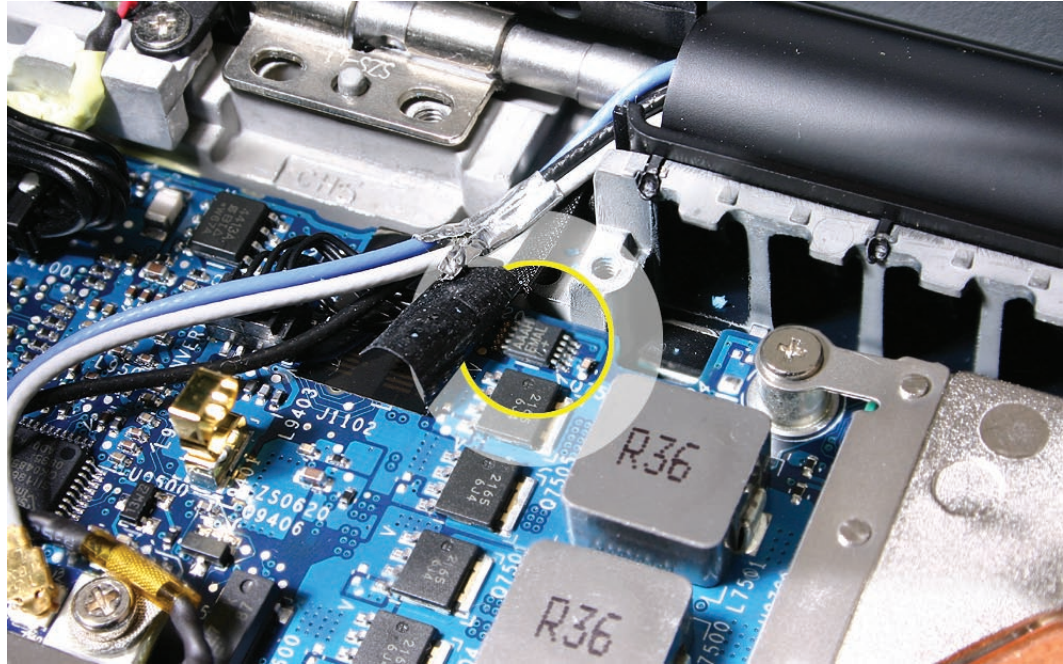

Important: Before installing the clutch block, make sure the cables are routed as shown:

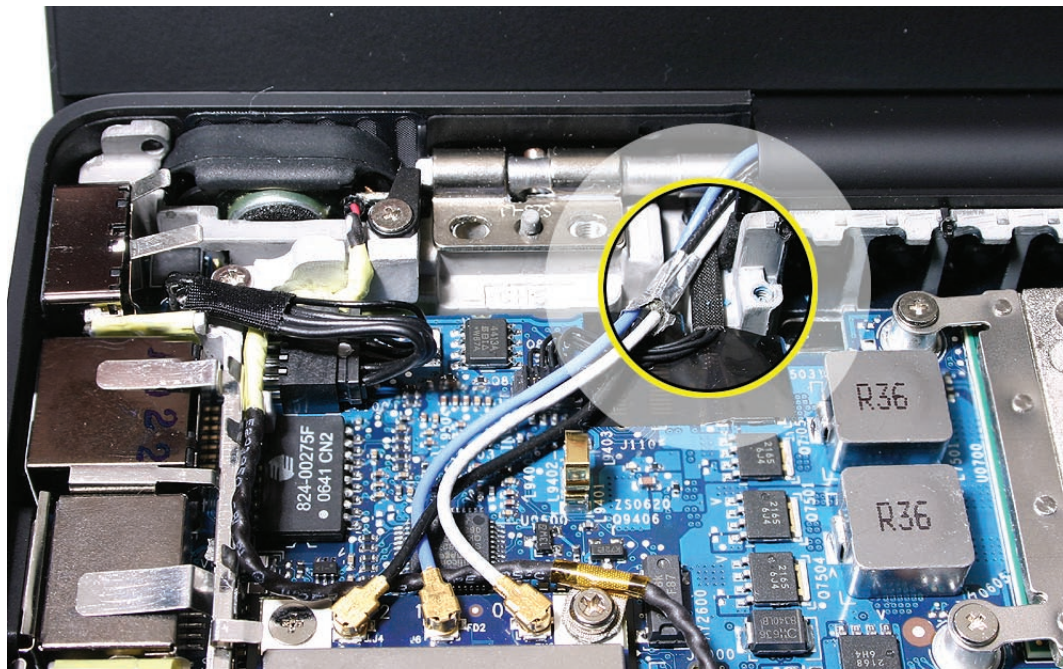

Late 2006 Model: The following image shows the clutch block correctly installed:

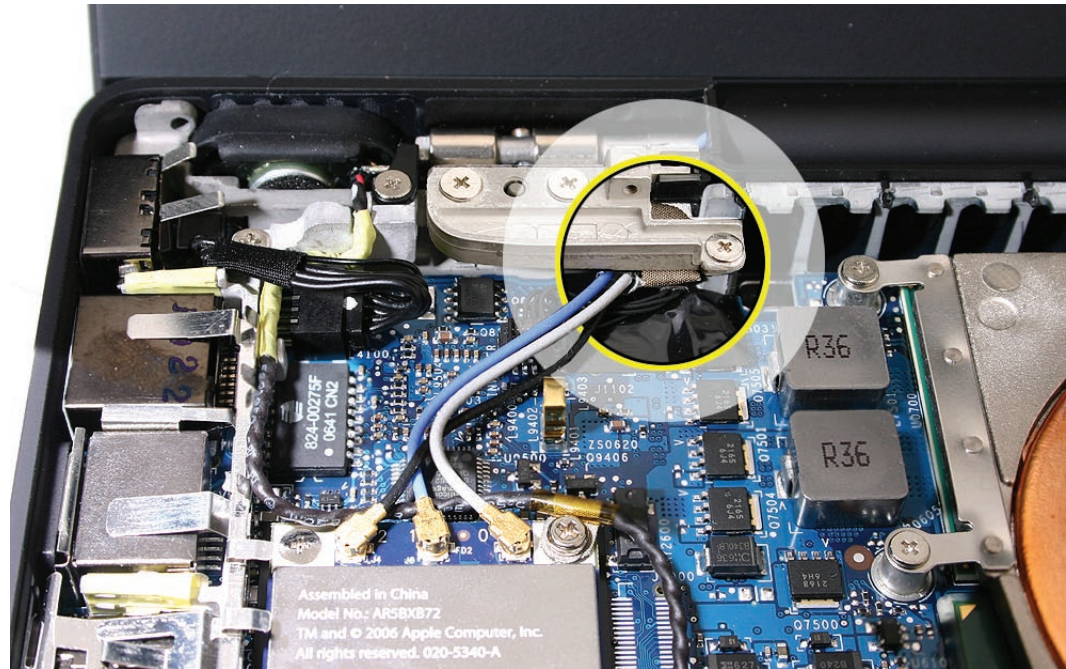

Replacement Note: If the inverter cable had been detached to service the display, make sure to install the inverter cable ground screw to the logic board. This screw is not visible when the left clutch block is installed. (The Late 2006 model does not have this screw.)

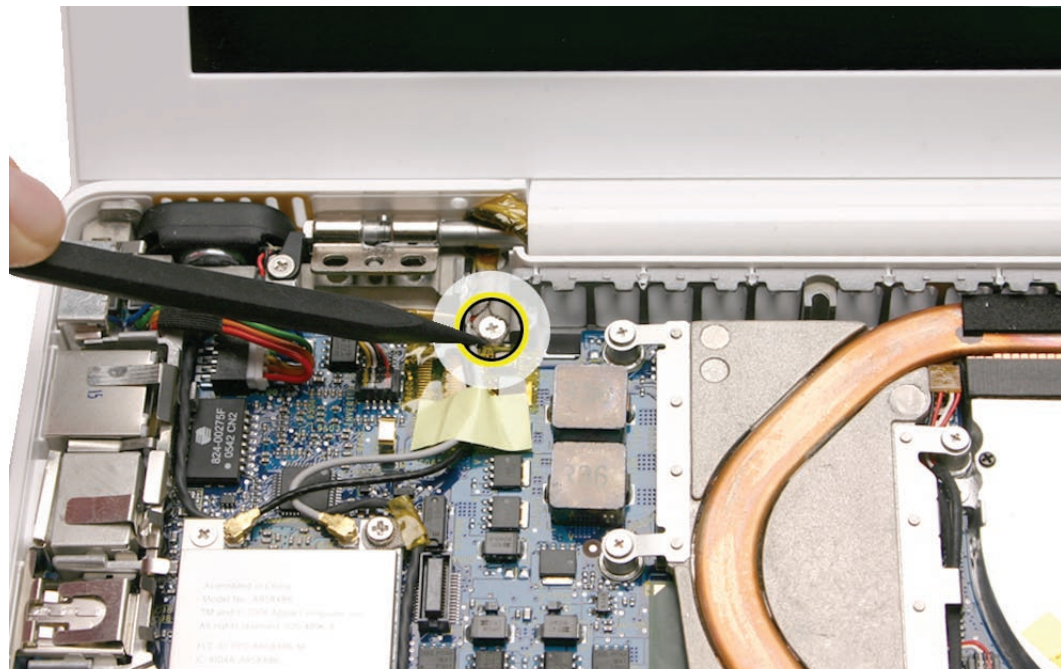

Replacement Note: If you are replacing the left and right clutch blocks as a pair, install the screws in the order shown. Otherwise, install the longest outer screw first.



Replacement Note: The left clutch cap and right clutch cap are not the same. The left clutch cap is pictured below.





Clutch Block, Right

Tools

- ESD wrist strap and mat
- Black stick (Apple part number 922-5065) or other nonconductive nylon or plastic flatblade tool
- Magnetic Phillips #0 screwdriver
- Stack of books (or other means of support for the display while removing screws from the display hinge)

Preliminary Steps

Before you begin, remove

- Battery
- RAM door
- Top case with keyboard
- Optical drive

Part Location

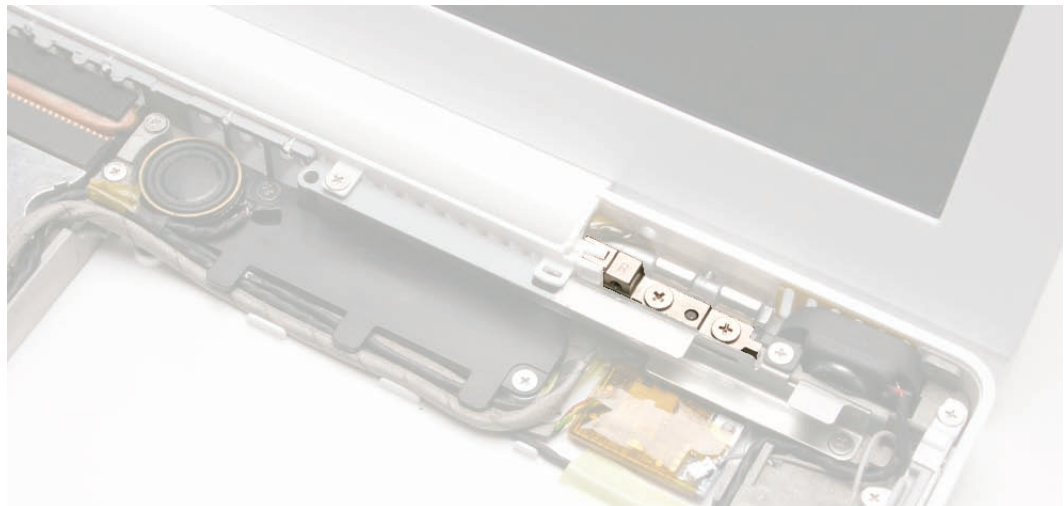

Procedure

1. Remove the screws from the right clutch block:
 - 10-mm long thick-stemmed outer screw, closest to the right corner of the bottom case
 - 6-mm long thick-stemmed inner screw

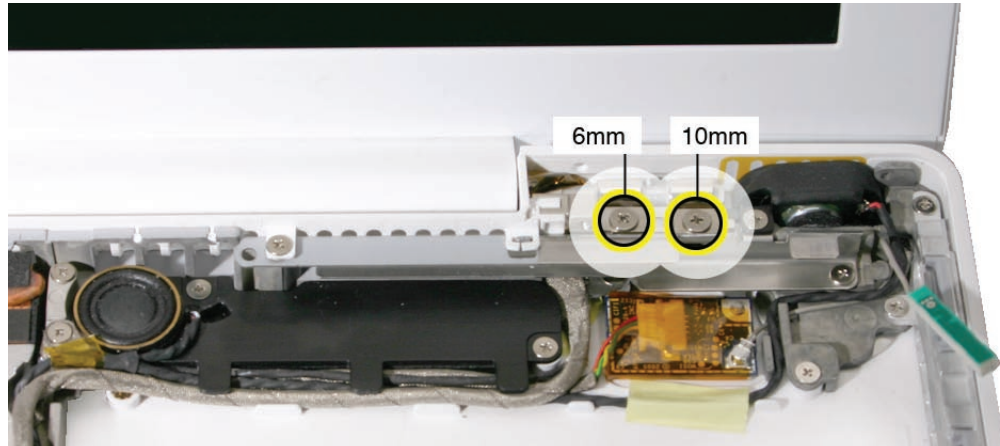

Use a black stick to remove the right clutch block from the computer assembly.

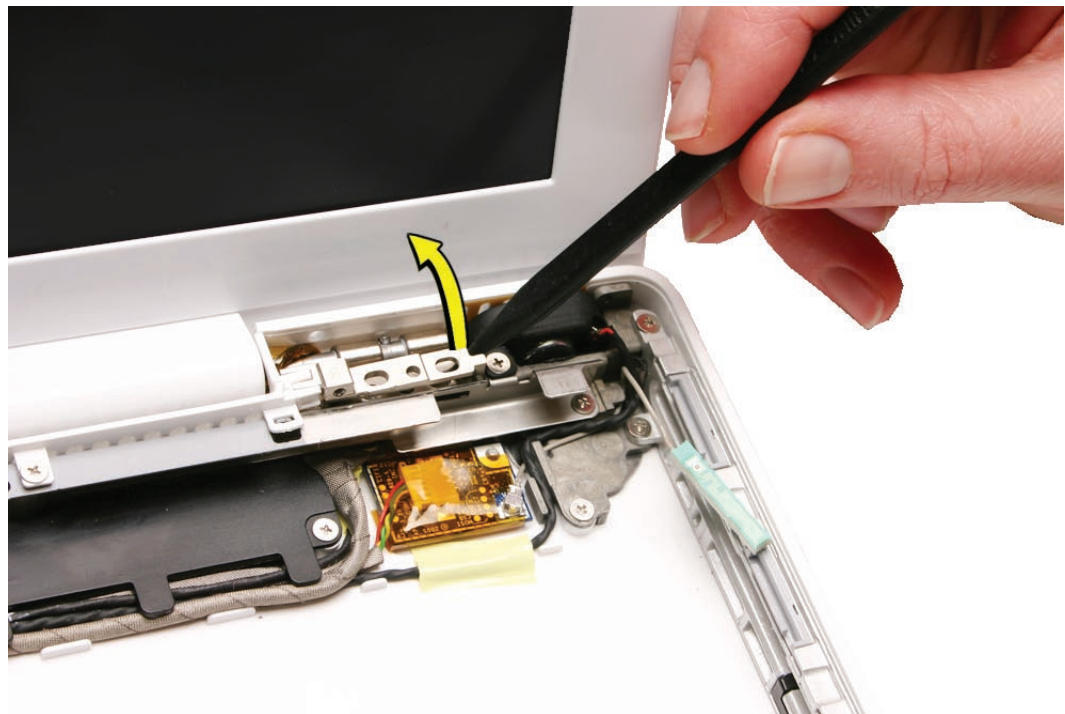

Replacement Note: Tilt the right end of the clutch block into the rear panel first. Then make sure the left end with the clutch cap aligns properly before installing the screws.

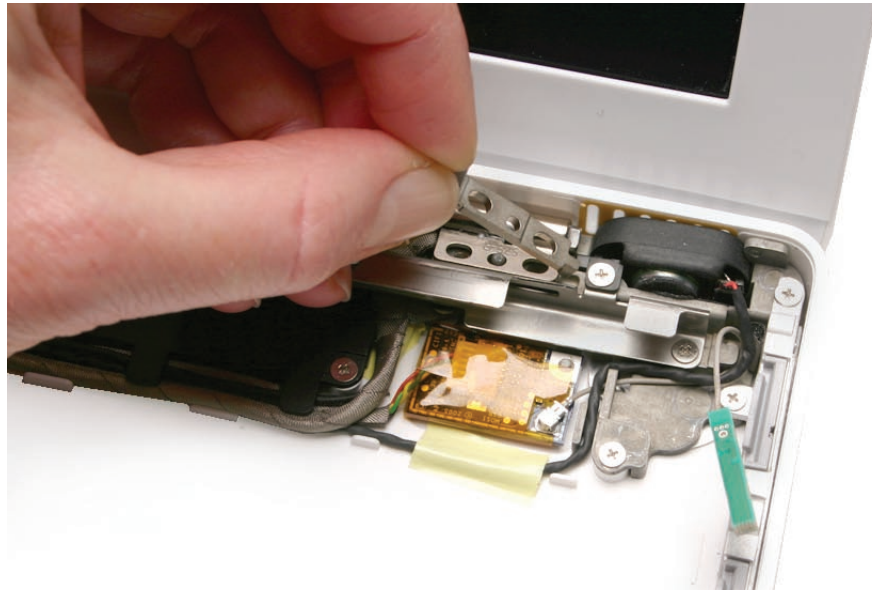

Note: Unlike the left clutch block, there is no mesh pad on the right clutch block.

Replacement Note: Notice how the right clutch cap comes loose as soon as the clutch block is removed. Make sure the right clutch cap is fitted into the clutch block, and hold it in place before installing the screws.



Replacement Note: Notice how the LVDS cable and microphone cable are routed around the right display hinge. Make sure they are routed as shown and cannot be pinched when the right clutch block and clutch cap are installed.



Replacement Note: If you are replacing the left and right clutch blocks as a pair, install the screws in the order shown. Otherwise, install the longest outer screw first.



Replacement Note: The right clutch cap and left clutch cap are not the same. The right clutch cap is pictured below.





Clutch Caps

(Refer to “Clutch Block, Left” and “Clutch Block, Right”)



Display Module

Note: Although the display module is not offered as an available part, removing it is required to access all internal display parts (except the bezel).

Tools

- ESD wrist strap and mat
- Black stick (Apple part number 922-5065) or other nonconductive nylon or plastic flatblade tool
- Magnetic Phillips #0 screwdriver
- Stack of books, weighted boxes, or other means of support for display while removing screws from hinge

Preliminary Steps

Before you begin, remove

- Battery
- RAM door
- Top case with keyboard
- Optical drive
- C-channel
- Clutch blocks, left and right

Part Location



Procedure

1. From the logic board, disconnect the following five connectors:
 - Two wireless card antenna cables (three wireless cables if Late 2006 model)
 - Microphone cable (located between I/O shield and left memory slot)
 - LVDS cable

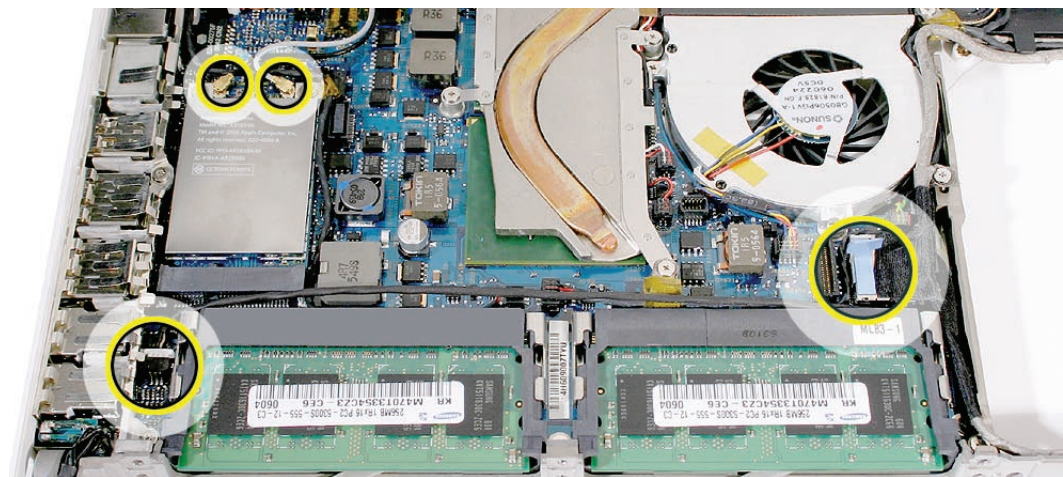

2. Remove the two ground screws that secure the cables to the midframe:
 - 7.5-mm long screw near the top end
 - 9-mm long screw from the middle

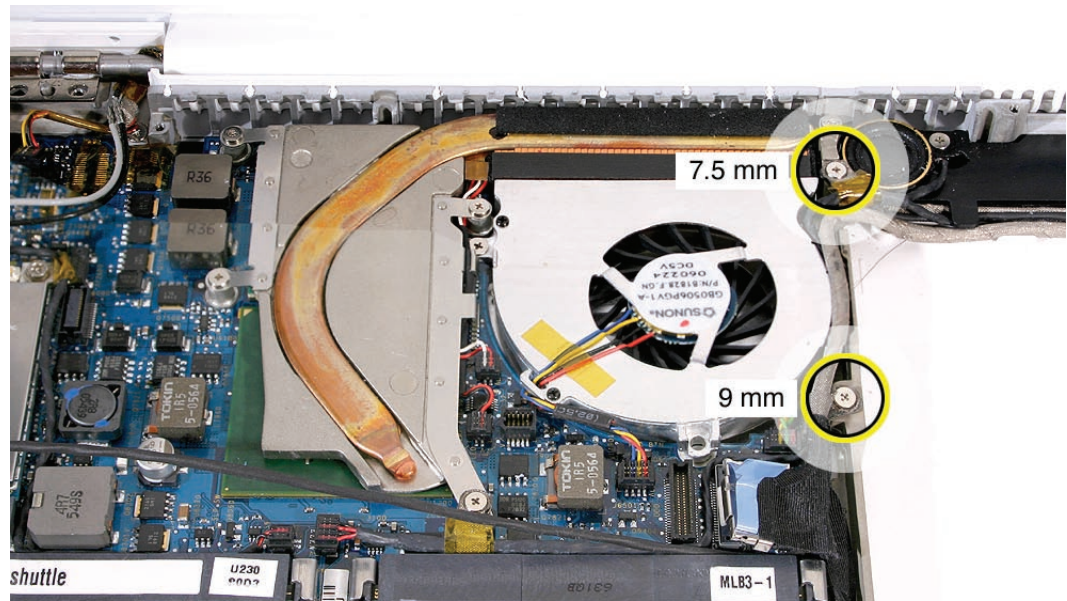

Warning: The subwoofer cone is a sensitive device. Avoid touching the subwoofer cone.

3. Carefully pull up the microphone cable from the channel above the memory slots.
4. Note that the microphone cable runs under the speaker cable at the ground screw area.
Remove the 8-mm long ground screw.,
Replacement Note: When reassembling the computer, the microphone cable must be routed **underneath** the speaker cable.

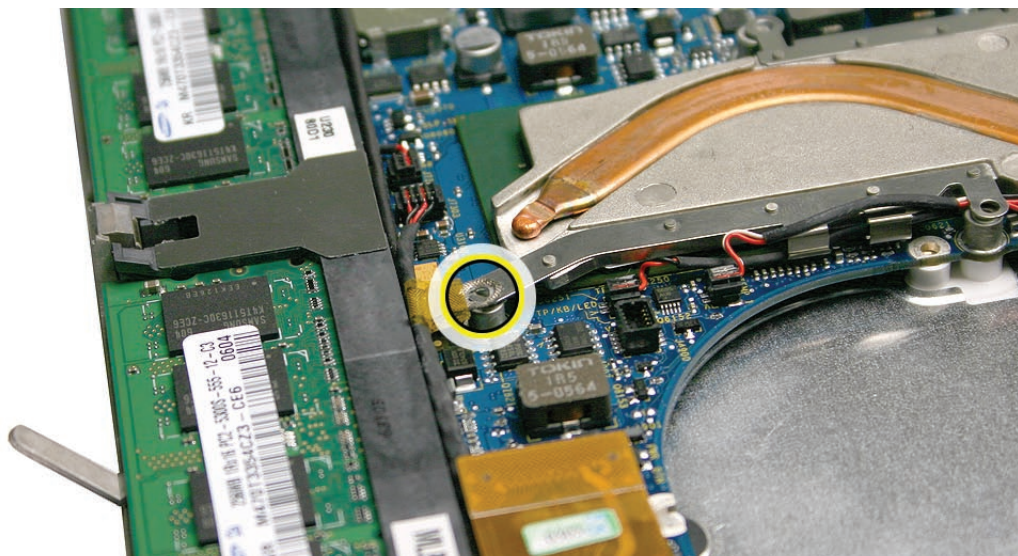

- Carefully unroute the LVDS cable and microphone cable from under the subwoofer tabs in the bottom case.

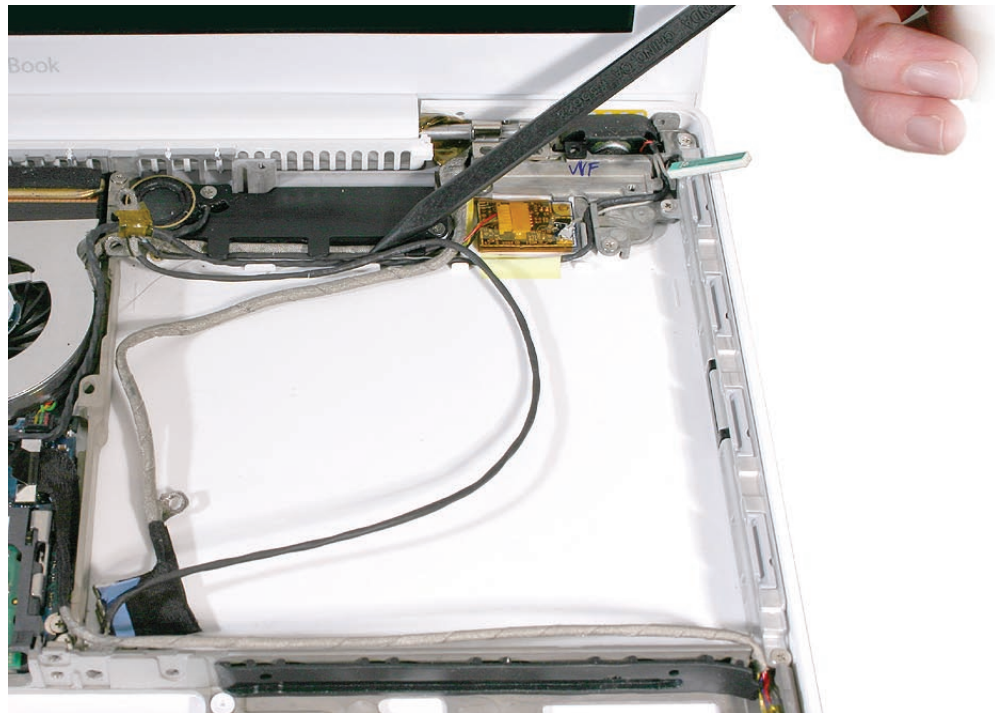

- Near the right hinge, remove the 3-mm long ground screw that anchors the LVDS cable to the upper right corner of the bottom case.

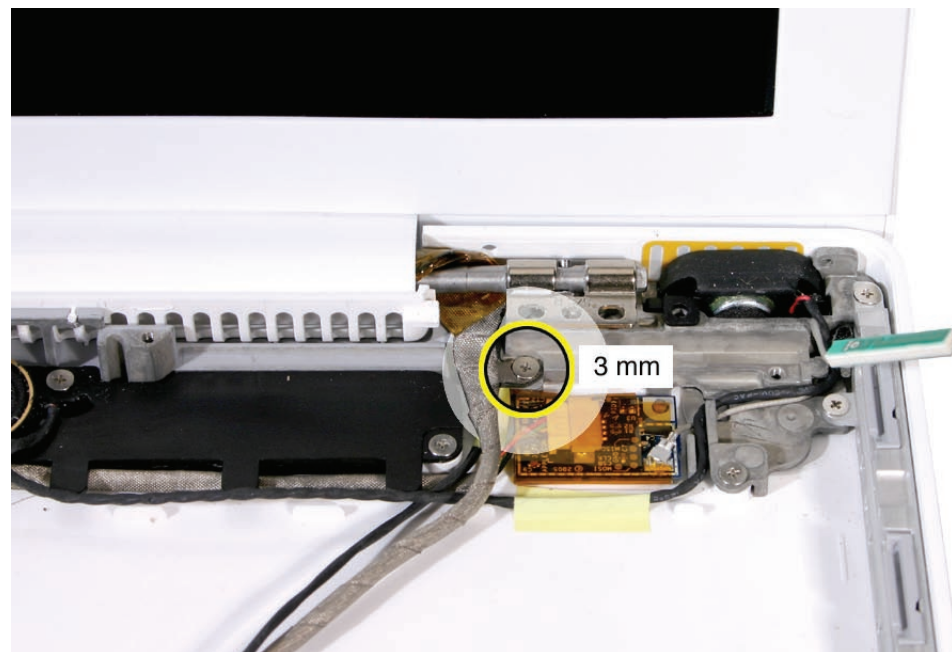

-
7. Near the left hinge, disconnect the inverter cable. (Late 2006 model is shown here.)

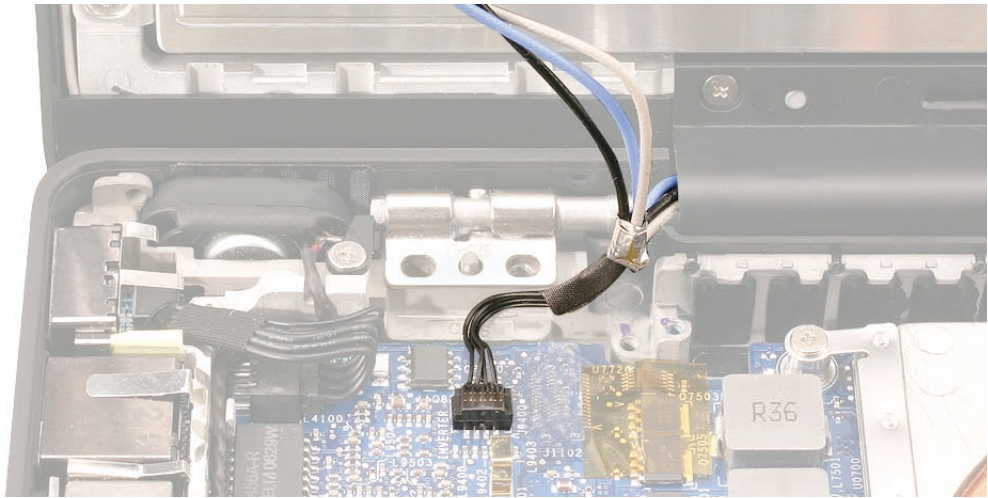

8. Holding the display module at the bezel, lift the module off of the computer assembly.



9. Install the replacement display module, and reassemble and test the computer.
Replacement Note: When installing the display, note how the cables are routed at the right side of the clutch barrel; The LVDS cable and microphone cable wrap around the back of the clutch barrel and are routed into the bottom case.

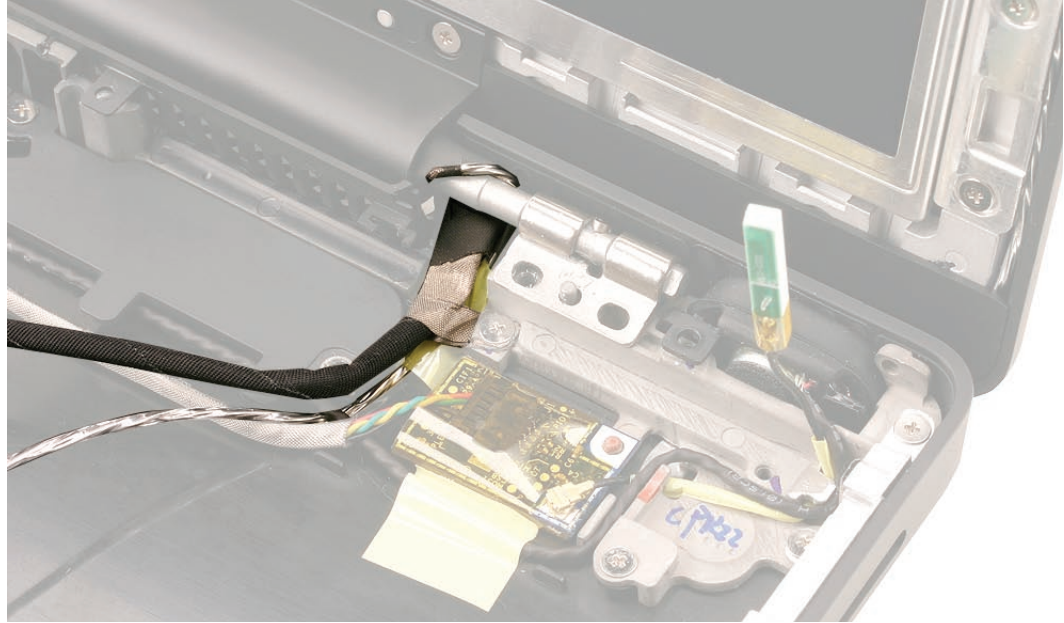

Replacement Note: The microphone cable routes under the right speaker cable and is secured to the bottom case with one strip of tape.



Replacement Note: Make sure that no cables can be pinched when installing the LVDS cable ground screw.





Bottom Case

Note: The bottom case includes the following parts:

- Feet that are heat-staked, so they are not removable
- Three integral frames: slot-load bezel frame, front bay frame, and rear frame
- Infrared (IR) sensor board in the front right corner
- Snubbers for hard drive

Tools

- Soft cloth
- ESD wrist strap and mat
- Magnetic Phillips #0 screwdriver
- Black stick (Apple part number 922-5065) or other nonconductive nylon or plastic flatblade tool

Preliminary Steps

Before you begin, remove

- Battery
- RAM door
- Memory cards
- Hard drive
- Top case with keyboard
- AirPort Card
- Battery connector with sleep switch
- Midframe
- Optical drive
- MagSafe DC-in board
- Left speaker
- C-channel
- Clutch blocks, left and right
- Clutch caps
- Display module
- Fan
- Heatsink
- Subwoofer with right speaker
- Bluetooth antenna
- Bluetooth board
- Bluetooth-to-logic board cable

-
- I/O frame
 - Logic board

Part Location

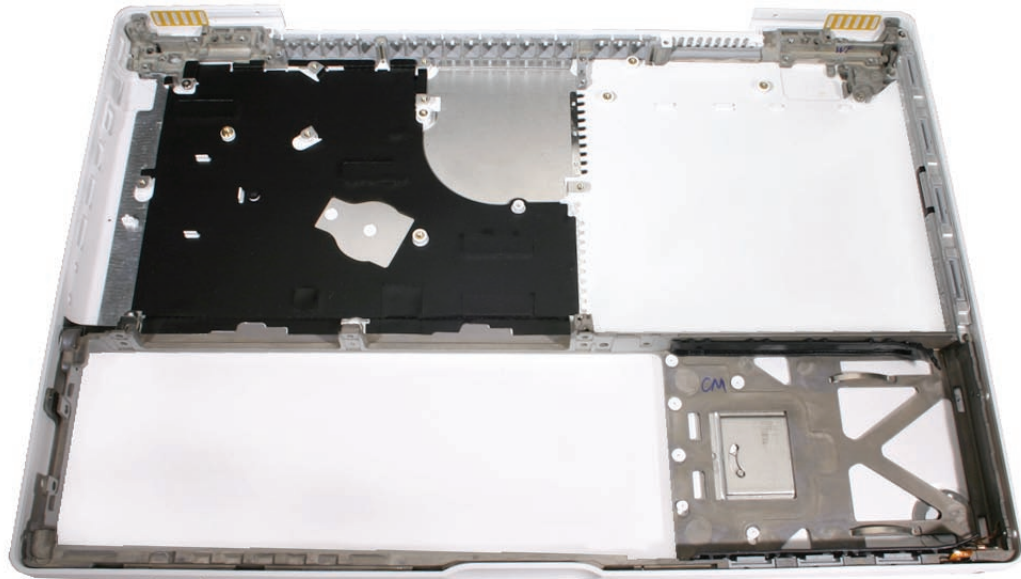

Procedure

When the parts listed in the “Preliminary Steps” have been removed, the remaining part is the bottom case.

Replacement Note: Make sure the bottom case is clean and free of dust before assembling the computer.

Important: Make sure that the mushroom-shaped rubber standoff is in place where shown before installing the logic board.

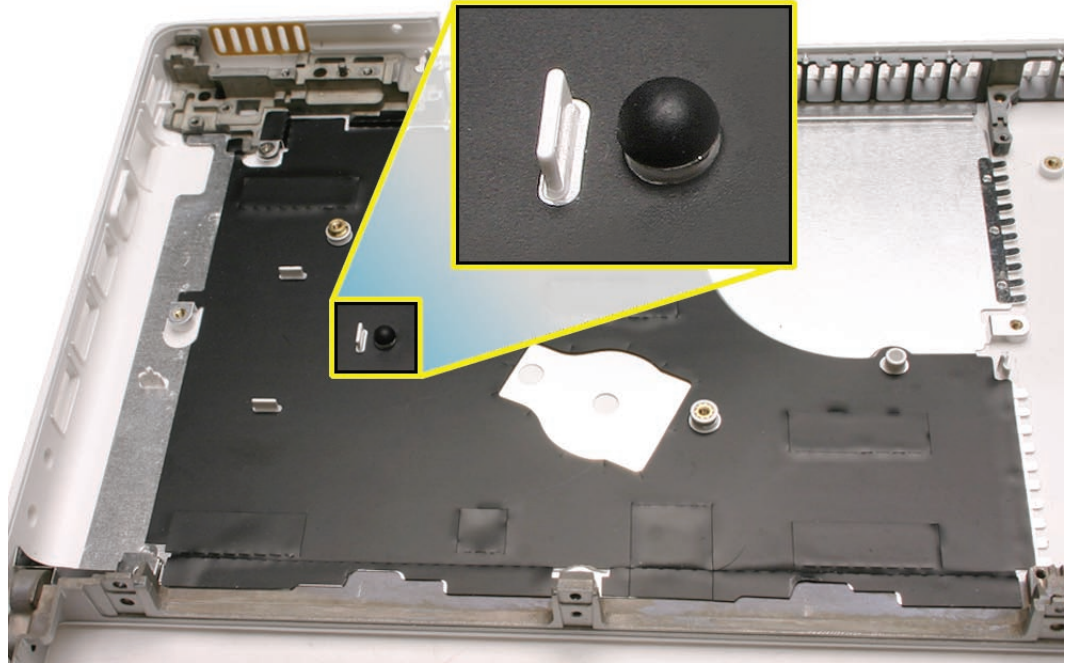

Note: If the rubber standoff comes loose, use needlenose pliers to install it.

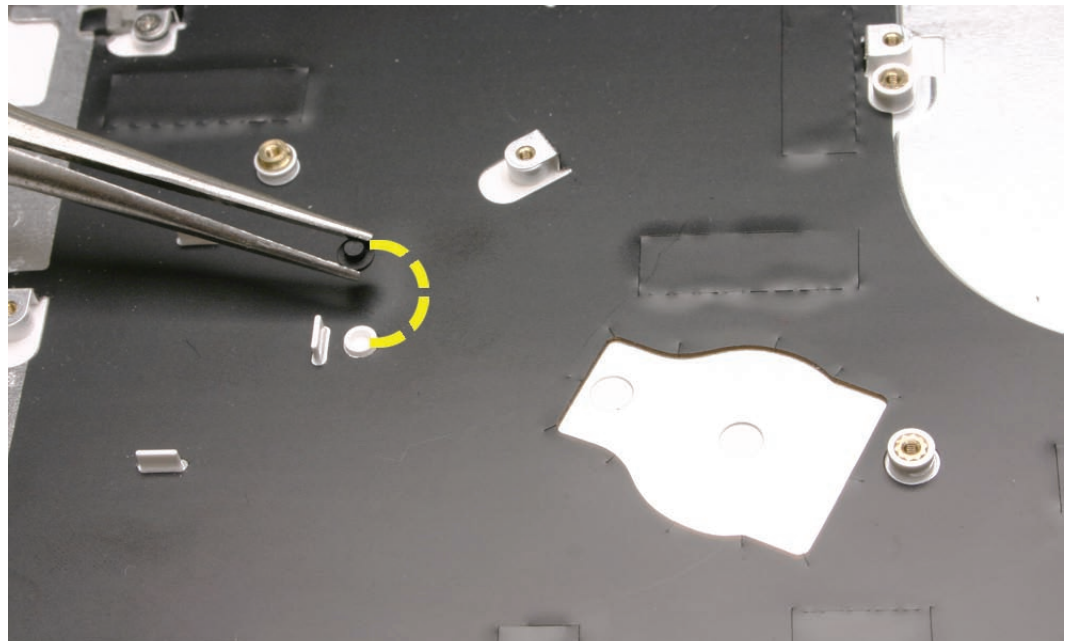

Replacement Caution: If any of the four bezel clips at the slot-load bezel come loose, simply insert them back in the slots. Make sure all four clips are in place while reassembling the computer and before installing the top case.

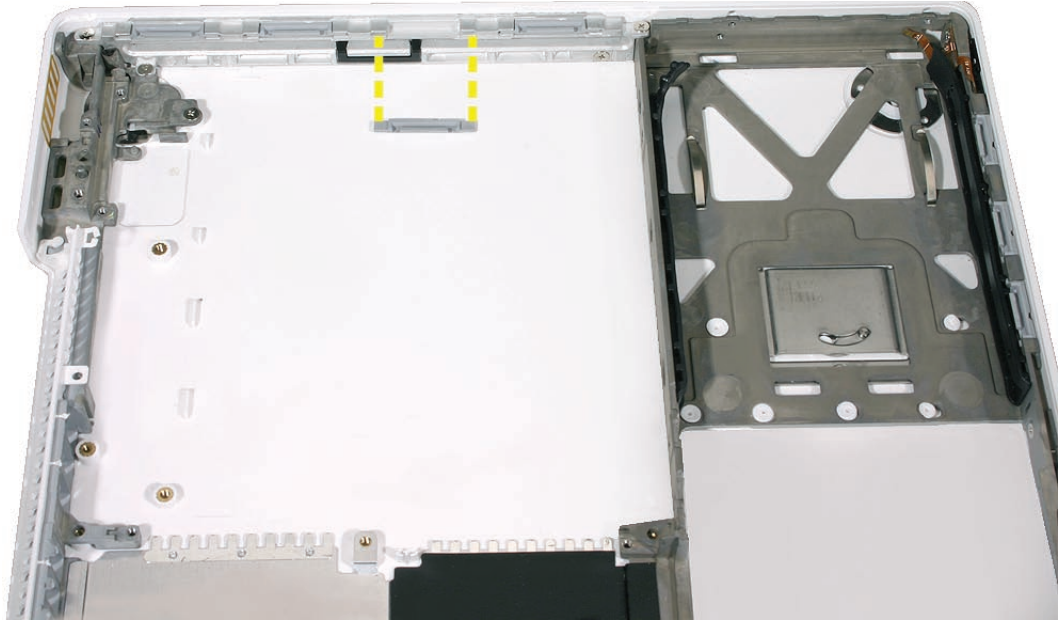



Clutch Cover

Tools

- ESD wrist strap and mat
- Magnetic Phillips #0 screwdriver
- Black stick (Apple probe tool, part number 922-5065) or other nonconductive nylon or plastic flatblade tool
- Access card (Apple part number 922-7172)

Preliminary Steps

Before you begin, remove

- Battery
- RAM door
- Top case with keyboard
- Optical drive
- Display module
- Display bezel

Part Location



Procedure

Important: The display cables might catch on the clutch cover as you remove it, so proceed slowly to prevent any cable damage.

1. Notice the cable exits points at each side of the clutch. Refer to the cable arrangement shown when reinstalling the clutch cover.

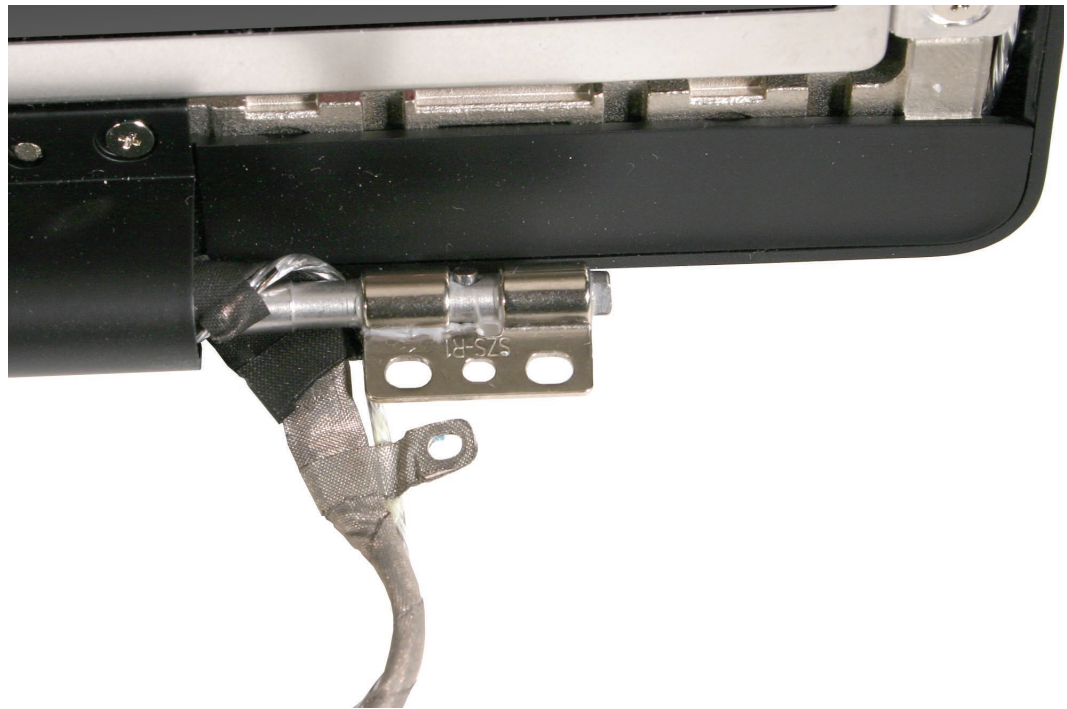

-
2. With the display assembly face up, remove the three 4-mm long screws along the top edge of the clutch cover.

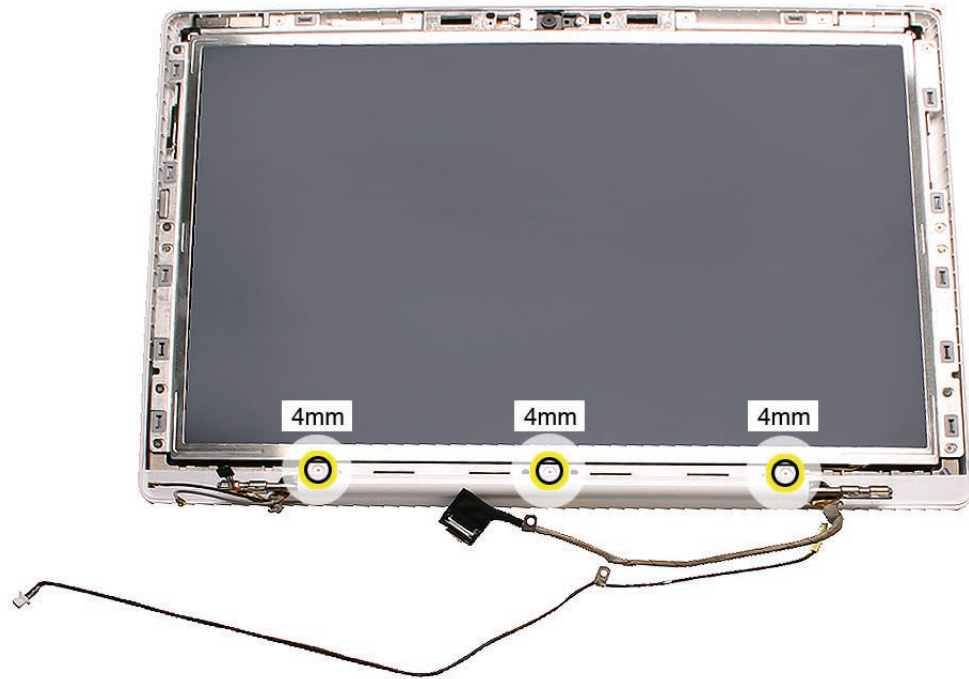

3. Slide an access card along the outer edge of the clutch cover to loosen it from the display rear housing.



4. Unsnap both ends of the clutch cover using a black stick.

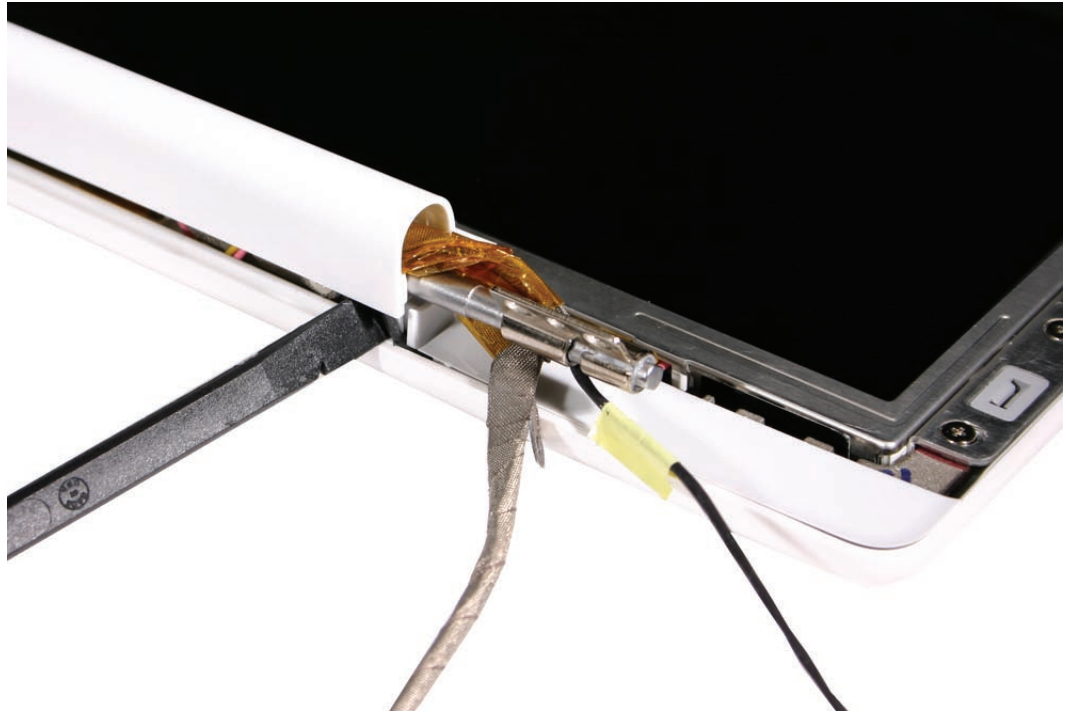

5. Holding the bundled display cables at each end of the clutch cover, carefully unwrap them to help raise up the clutch cover.



- Without straining cables, carefully pull the clutch cover off of the display assembly.

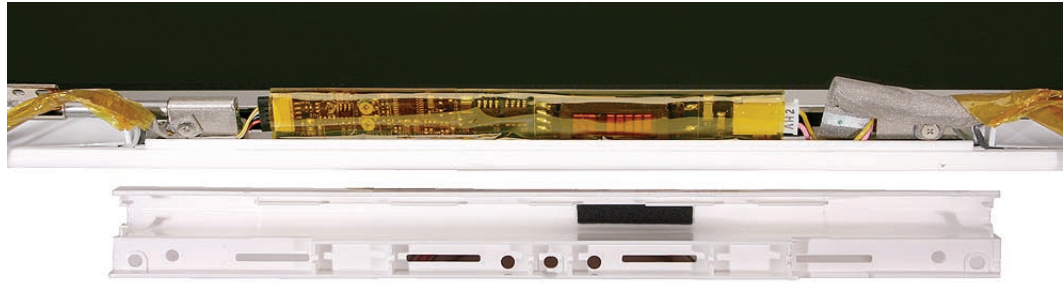

- Install the replacement clutch cover, and reassemble and test the computer.



Replacement Note: The inner channel of the clutch cover includes a foam pad that helps stabilize the inverter board. Do not remove it.

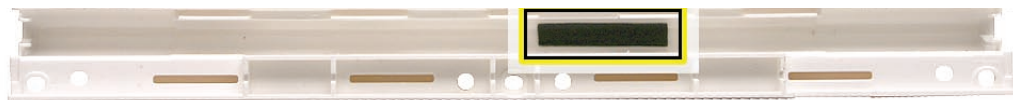

Replacement Note: Be careful when securing the snaps at each end of the clutch cover. Cables wrap around the barrel at the hinges, but tucking in the cables just right is difficult, and the cables are subject to pinching damage when the clutch cover is installed.

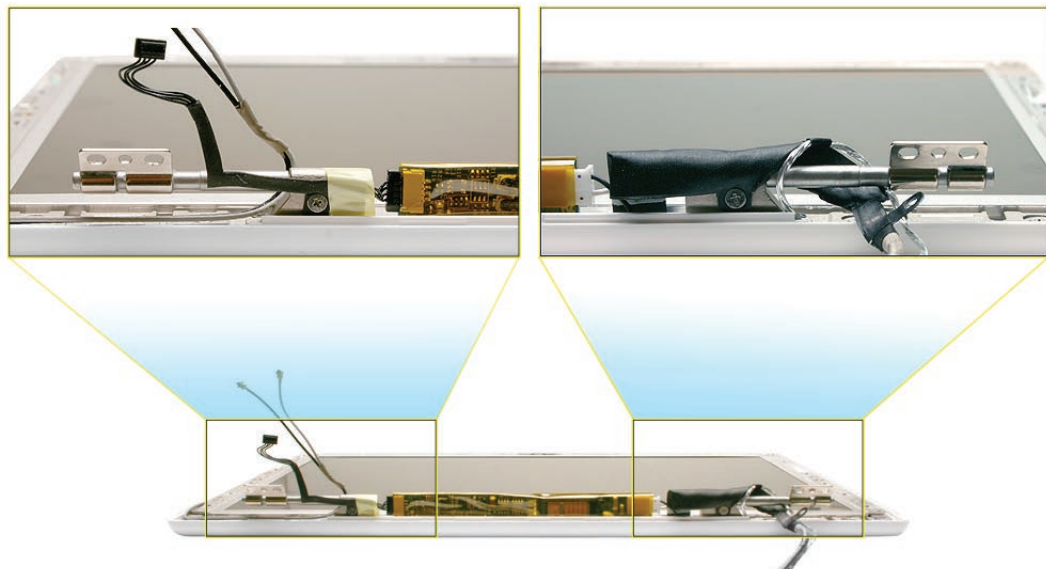

Replacement Caution: Notice how the display cables are wrapped around the clutch. Check that they are wrapped as shown before reassembling the computer.





Bezel Scoops, Left and Right

Tools

- ESD wrist strap and mat
- Black stick (Apple probe tool, part number 922-5065) or other nonconductive nylon or plastic flatblade tool

Preliminary Steps

Before you begin, remove

- Battery
- RAM door
- Top case with keyboard
- Optical drive
- Display module
- Display bezel
- Clutch cover
- Spacers at bezel scoops

Part Location



Procedure

1. With the bezel spacers removed, use a black stick to loosen the outer edge of the bezel scoop and push it toward the display face. Repeat for the other bezel scoop.



Replacement Note: Before replacing the bezel scoops, make sure that the cables that are routed under the bezel scoops have no slack. Refer to the following images for the correct cable routing.



Late 2005 Model:

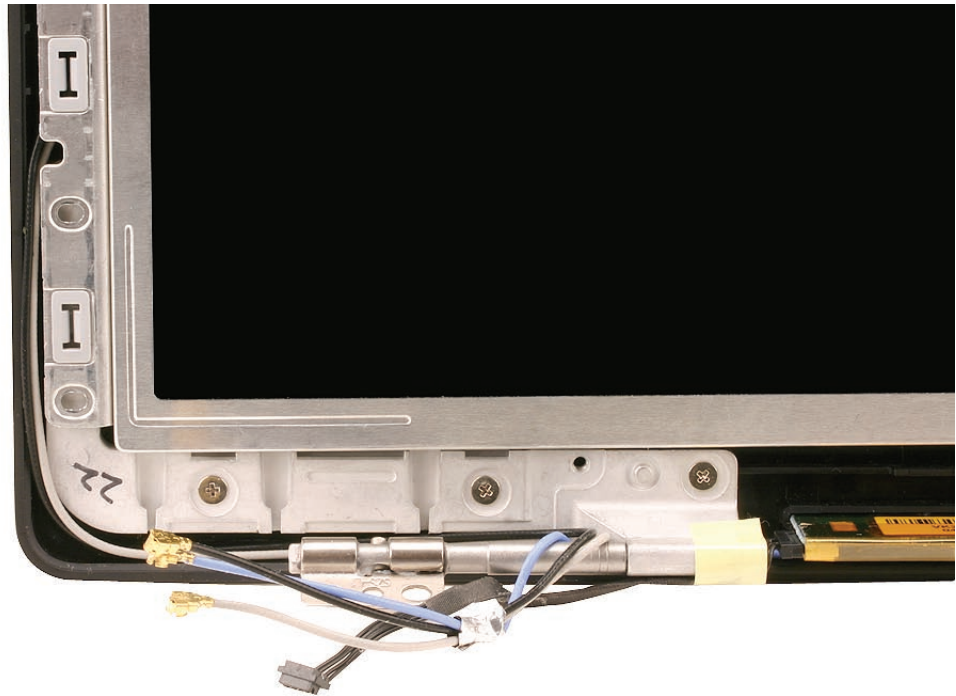

Replacement Note: On the underside of each bezel scoop, note that the three raised tabs match up with the three slots in the display hinge. Align the tabs to the slots.

Replacement Note: With the cables tucked in, slide on the bezel scoop.

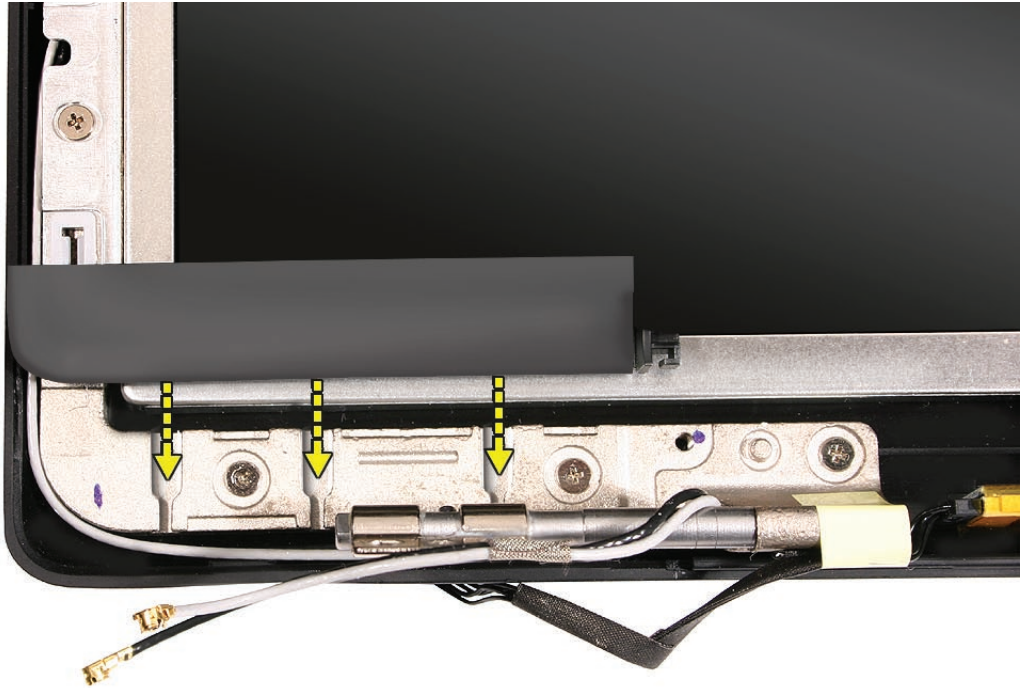



LCD Panel

Tools

- Soft cloth
- ESD wrist strap and mat
- Magnetic Phillips #0 screwdriver
- Black stick (Apple part number 922-5065) or other nonconductive nylon or plastic flatblade tool

Preliminary Steps

Before you begin, remove

- Battery
- RAM door
- Memory cards
- Hard drive
- Top case with keyboard
- Optical drive
- Display bezel
- Display module
- Clutch cover
- Spacers at bezel scoops
- Bezel scoops
- LCD panel assembly
- LVDS cable
- Bezel braces, left and right, with attached cables
- Camera assembly

Part Location

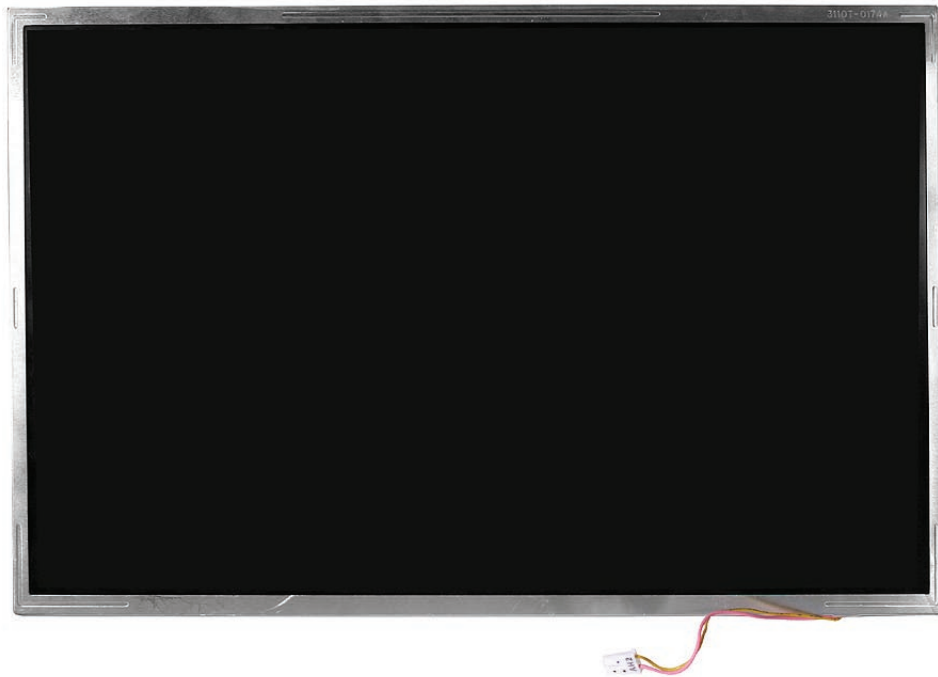

Procedure

1. With all of the preliminary steps performed, turn over the LCD panel and check for any remaining strips of tape.



-
2. Install the replacement LCD panel, and reassemble and test the computer.

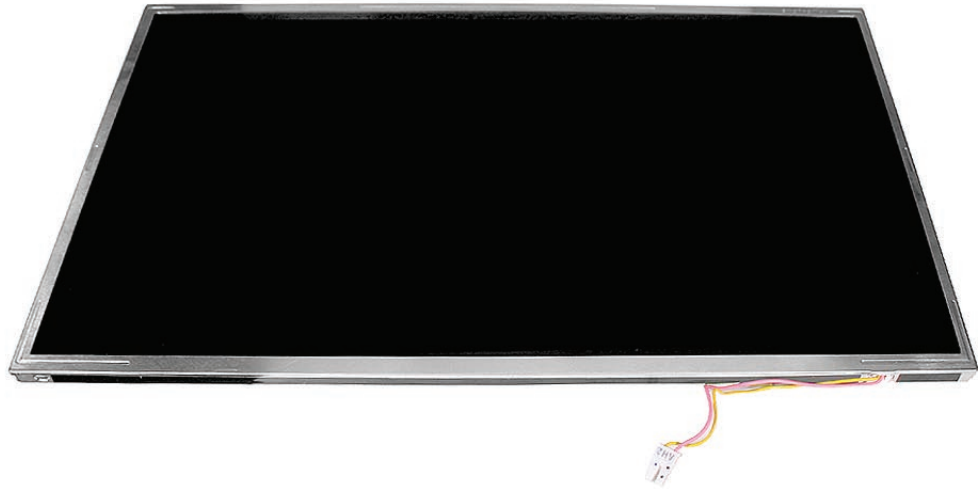

Replacement Note: When reassembling the computer, make sure the LCD cable is bent, but not pinched or damaged.

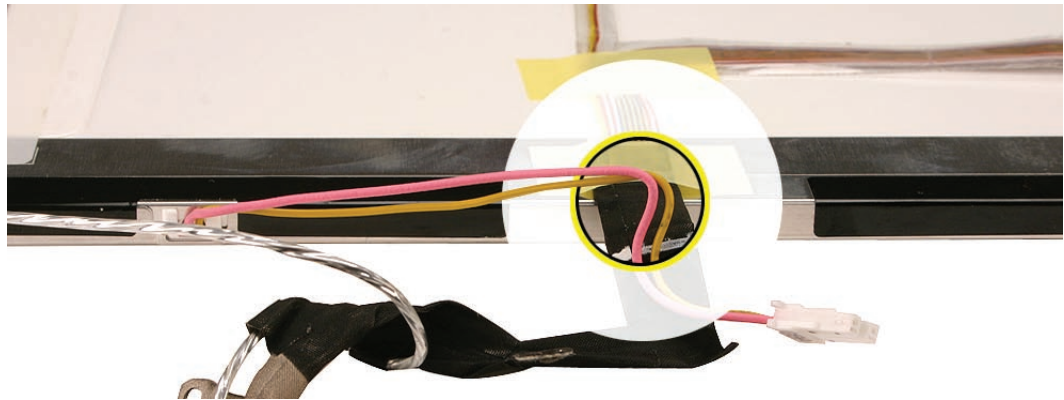

Replacement Note: Start by connecting the LVDS cable and USB flex line first. Then place the tape before continuing with the rest of the reassembly.

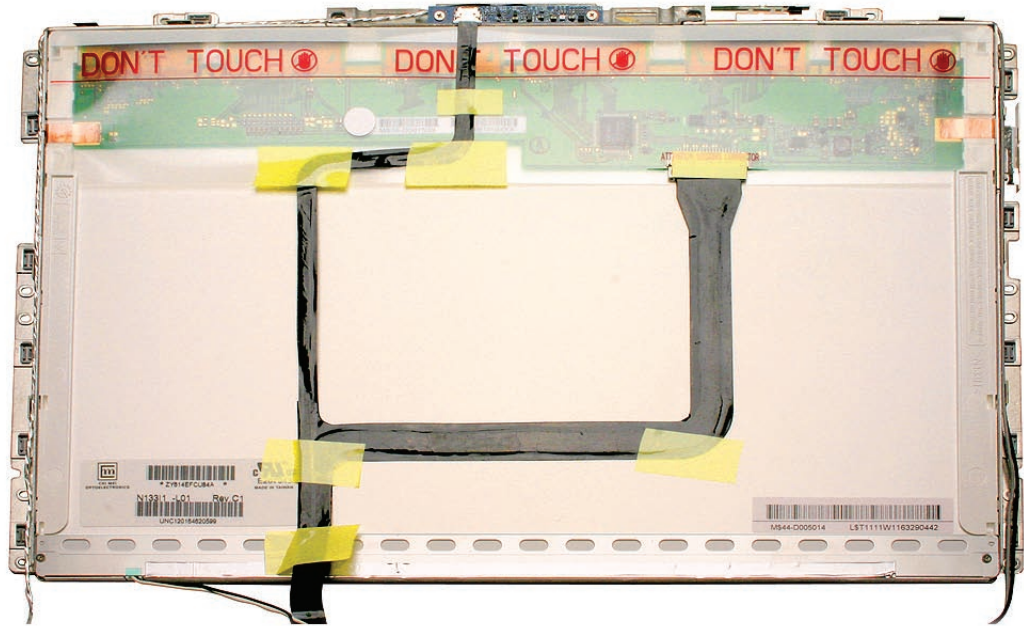

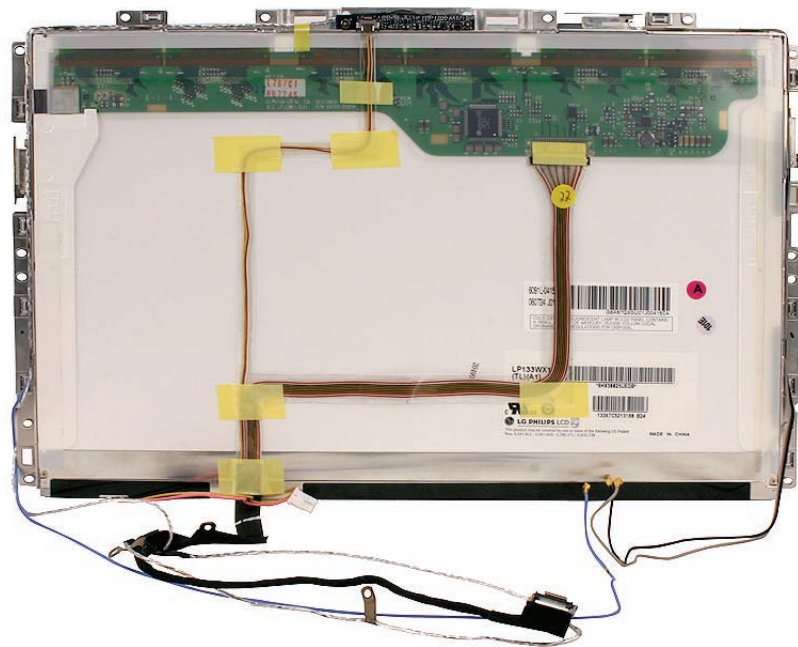

Late 2006 Model:



Late 2006 Model Replacement Note: For the Late 2006 model, there are three possible panel manufacturers: AUO, Chi Mei, and Samsung. Refer to the following table when replacing the LCD panel and/or the LVDS cable:

- If you are replacing the LCD panel, be sure to also replace the LVDS cable and any conductive tape that comes bundled in the 661-4211 kit. (Do not order a separate LVDS cable.)
- If you are replacing just the LVDS cable but not the panel, be sure to check the LCD panel logo as shown in the table to order the appropriate LVDS cable (922-7889 or 922-7890).

LCD Panel Logo	Display Part Number (a bundled kit that includes the LCD panel and LVDS cable)	Compatible LVDS Cable
AUO 	661-4211	922-7889
Chi Mei 	661-4211	922-7889
Samsung 	661-4211	922-7890



Antenna Receptors and Cables, Top and Left

Tools

- Soft cloth
- ESD wrist strap and mat
- Magnetic Phillips #0 screwdriver
- Black stick (Apple part number 922-5065) or other nonconductive nylon or plastic flatblade tool
- Jeweler's flatblade screwdriver

Preliminary Steps

Before you begin, remove

- Battery
- RAM door
- Memory cards
- Hard drive
- Top case with keyboard
- Optical drive
- Display bezel
- Display module
- Clutch cover
- Spacers at bezel scoops
- Bezel scoops
- Display rear housing

Part Location

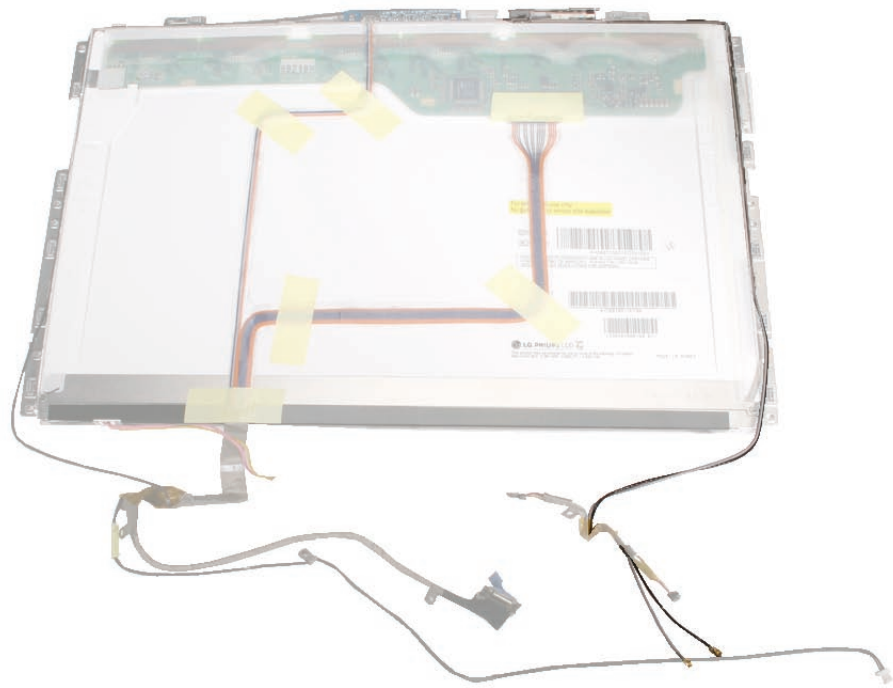

Procedure

Notice that the antenna cables are two separate cables (black and gray) that run along the left front side of the LCD panel brace. The gray cable is also routed over the top corner of the LCD panel.

1. Carefully unroute the cables from the left brace.

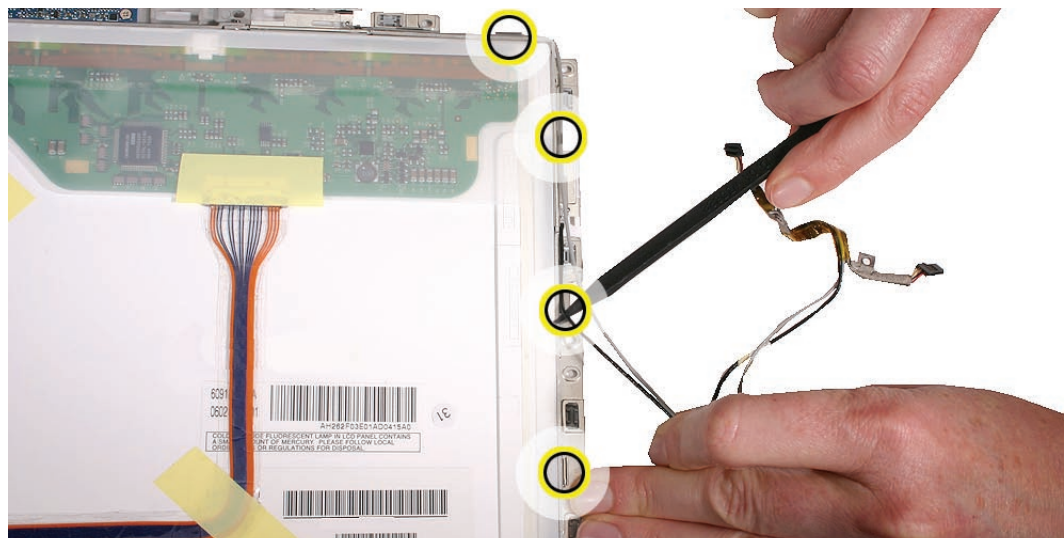

2. Remove the three identical 3-mm long screws from the left brace.

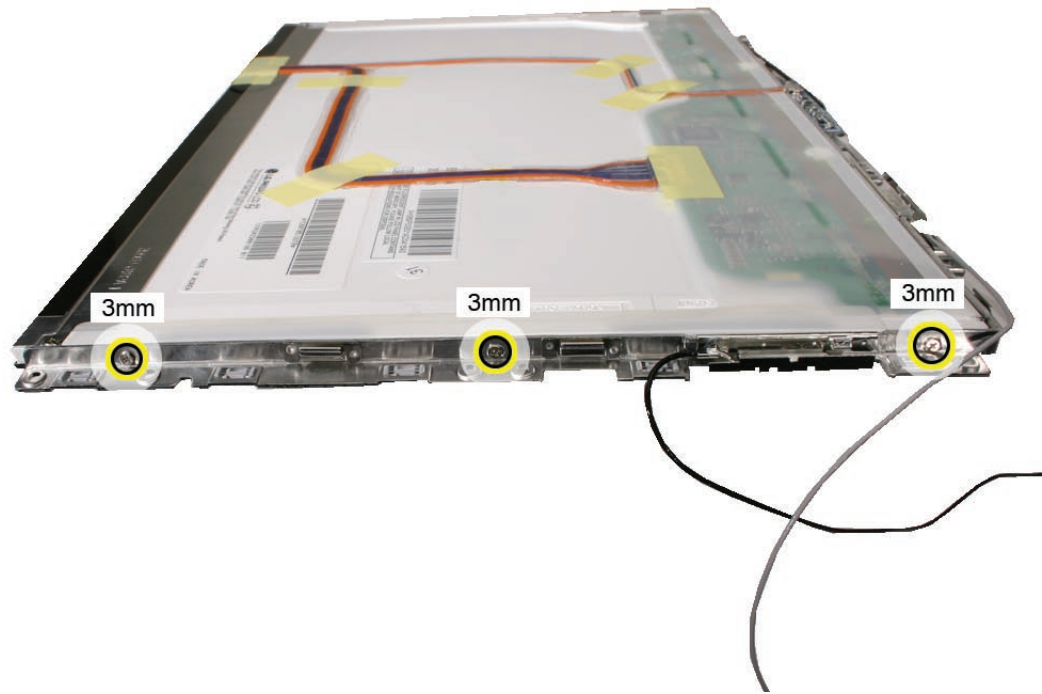

3. Rotate the top corner of the LCD panel and remove the 3-mm long screw from the left brace and camera bracket.

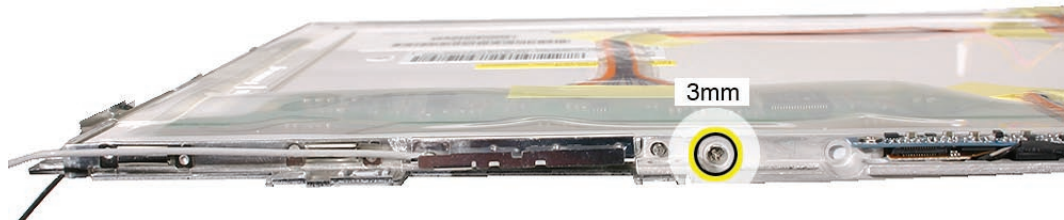

4. Slightly lift up the end of the camera bracket to free the locator pin on the end of the left brace.

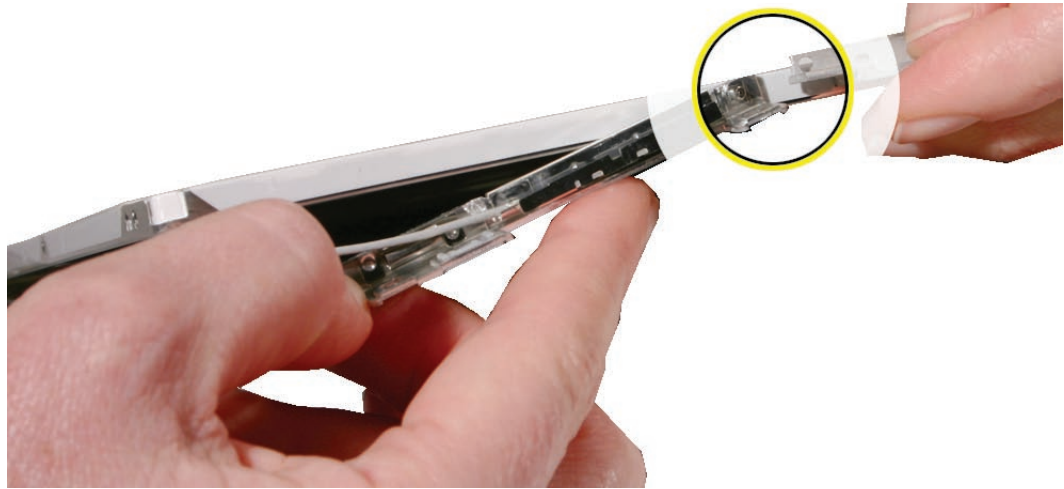

Replacement Note: To avoid straining cables, be sure to align the locator pin and hole before sliding on the left brace.

5. Move the left brace away from the LCD panel assembly, and use a jeweler's flatblade screwdriver placed underneath the antenna receptor to carefully pry up the antenna receptor.

Important: To support the solder joint where the cable meets the receptor, keep the antenna cable in the last brace tab while loosening the receptor from the brace.

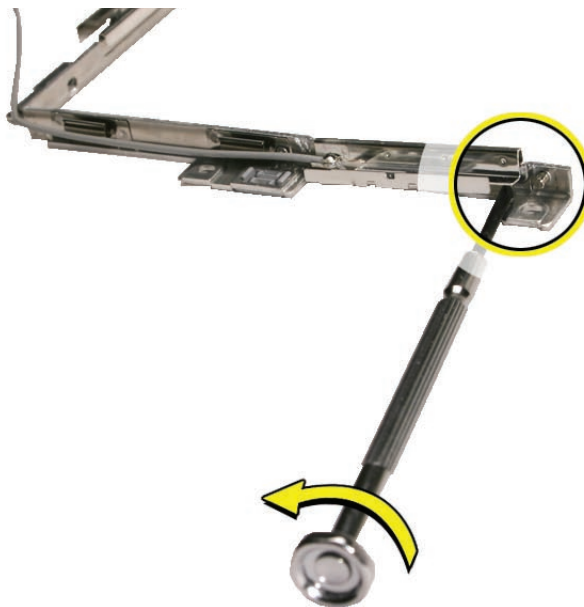

Caution: The antenna receptors are friction-fit with a metal fold that hooks onto the left brace. The antenna receptors are delicate and easily bent. Do not press on nor pinch the antenna receptors.

Replacement Note: Secure the antenna receptors by placing them over the recessed brace area and pressing only on the metal fold. You will hear an audible snap when they are installed.



6. Install the replacement antenna cables, and reassemble and test the computer.



Antenna Receptor and Cable, Right (Late 2006 Model Only)

Tools

- Soft cloth
- ESD wrist strap and mat
- Magnetic Phillips #0 screwdriver
- Black stick (Apple part number 922-5065) or other nonconductive nylon or plastic flatblade tool
- Jeweler's flatblade screwdriver

Preliminary Steps

Before you begin, remove

- Battery
- RAM door
- Memory cards
- Hard drive
- Top case with keyboard
- Optical drive
- Display bezel
- Display module
- Clutch cover
- Spacers at bezel scoops
- Bezel scoops
- Inverter board

Part Location

Note: The blue wireless cable, as shown below, leads to the right antenna receptor.

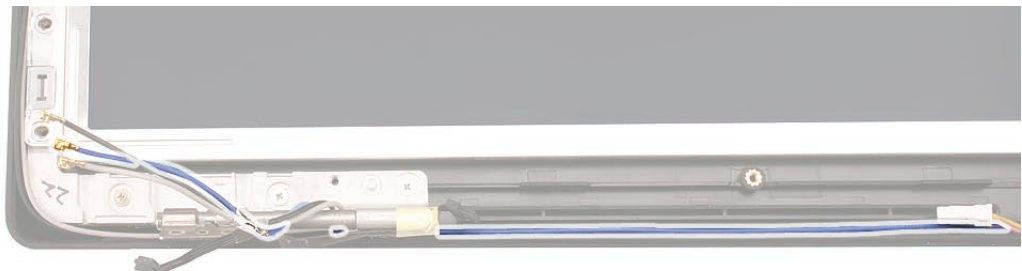

Procedure

1. Note the path of the blue antenna cable as it runs along the bottom of the display rear housing, underneath the microphone cable, and up the right side of the display.



2. Following the order shown, remove the twelve identical 4.5-mm long screws around the frame of the LCD panel.

Caution: To prevent scratches or other cosmetic damage to the display housing, use a soft cloth as a protective layer when removing the screws.

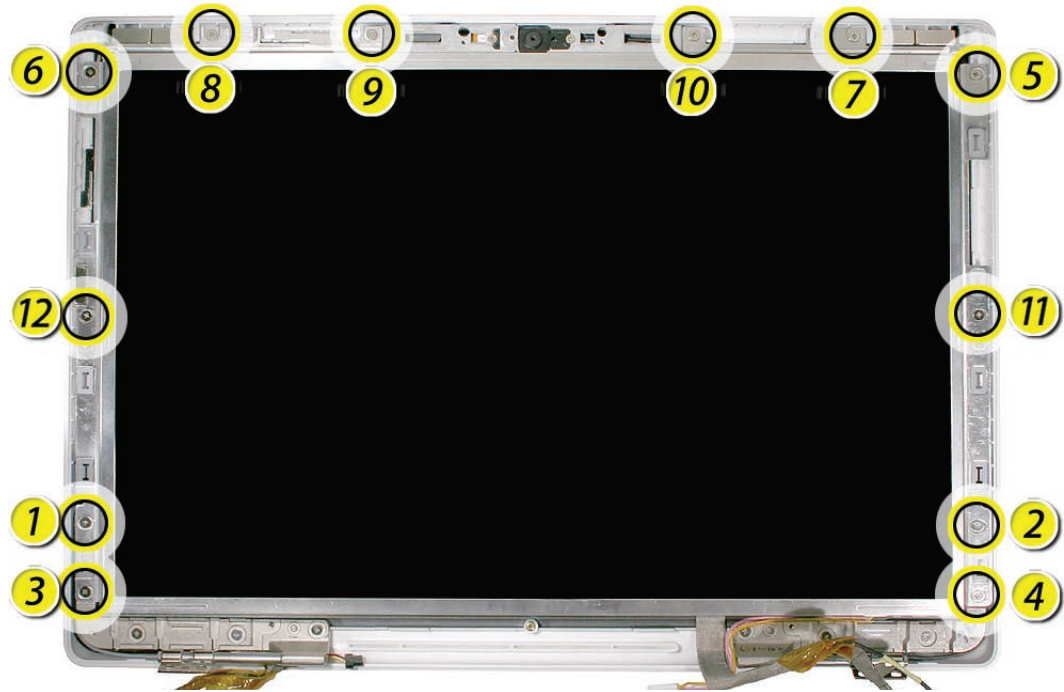

Replacement Note: Refer to the section LCD Panel Assembly when reinstalling the LCD panel in the display rear housing.

3. Without straining the blue antenna cable, tilt up the LCD panel.

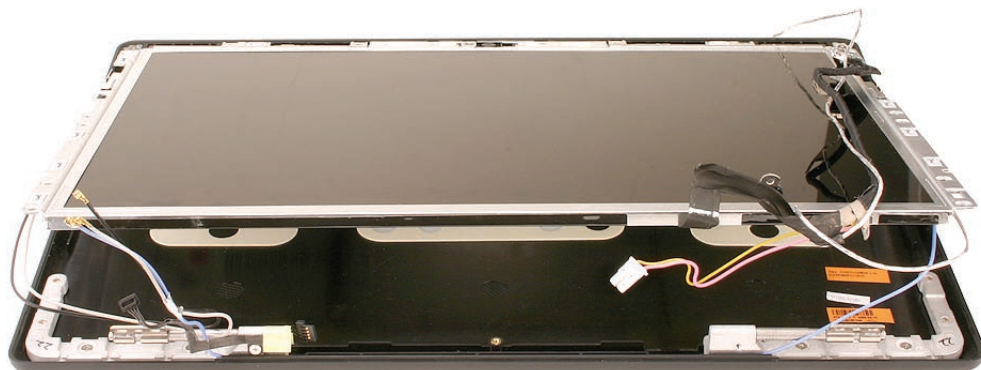

4. Remove the strip of tape that wraps the noninsulated section of the antenna cable bundle.

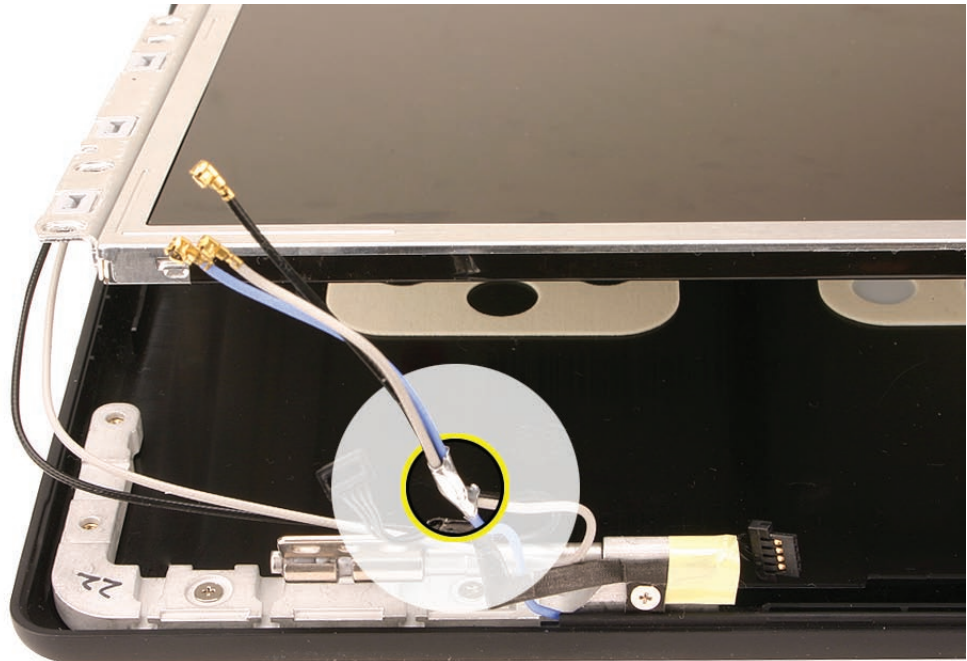

Replacement Note: Be sure to wrap the cables with a new strip of tape when reassembling the display.

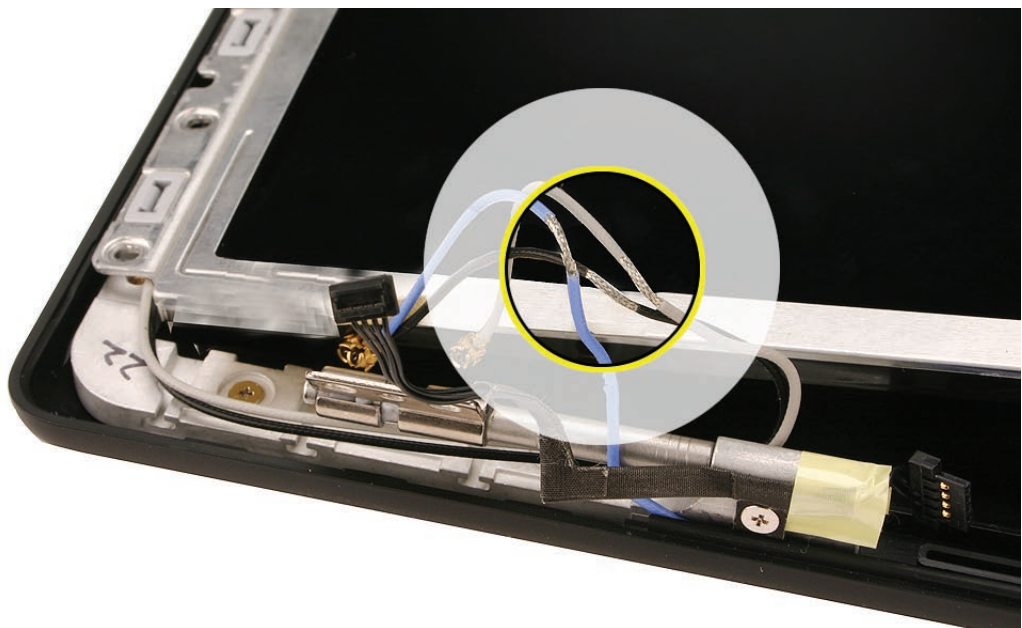

5. Thread the blue antenna cable from left to right out of the left end of the display rear housing.

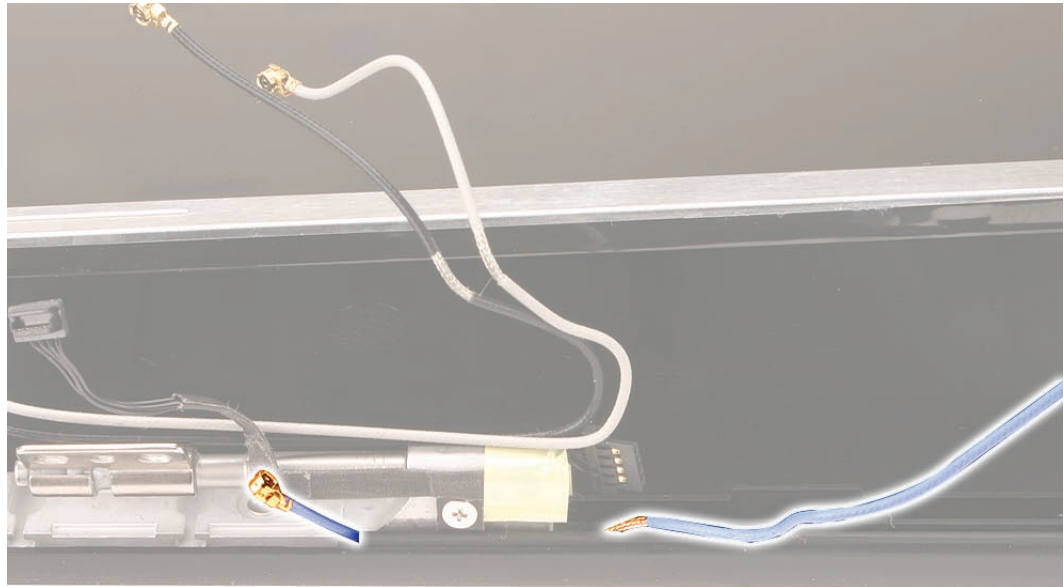

6. At the right display hinge, thread the blue antenna cable from left to right out of the right end of the display rear housing.

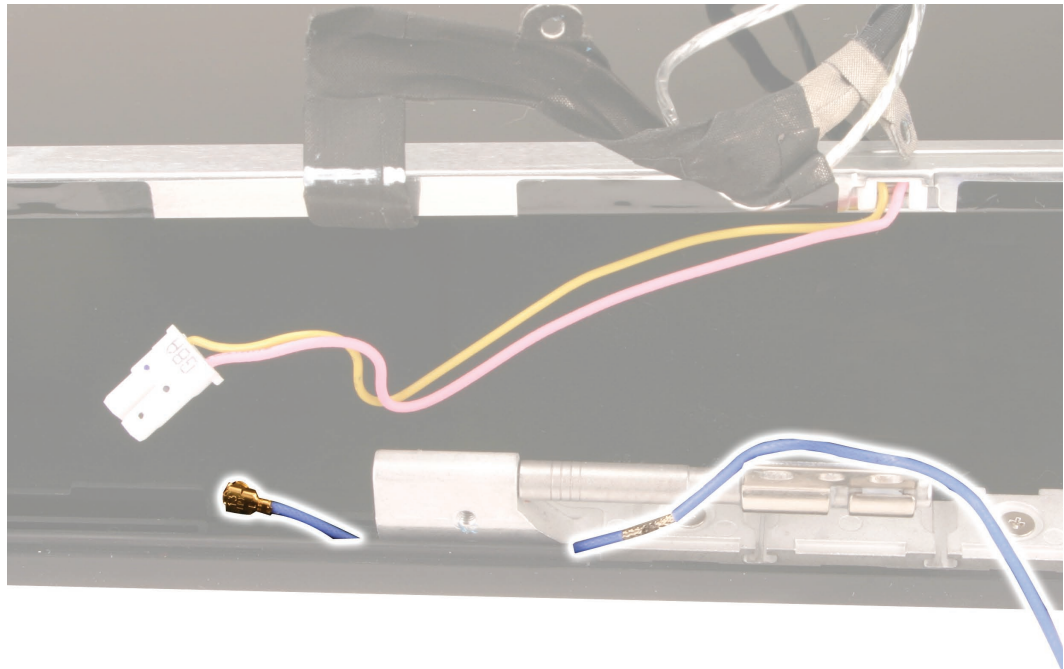

7. With the blue antenna cable free from the display rear housing, remove the LCD panel assembly and place it face down on a soft clean cloth.
8. Carefully unroute the silver colored microphone cable and the blue antenna cable from the right brace.

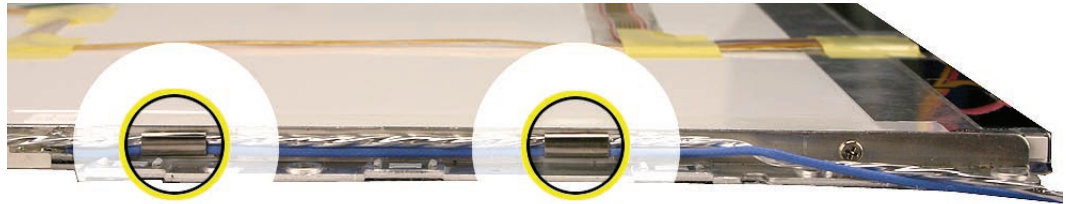

9. Remove the two identical screws that secure the right bezel brace to the LCD panel.



10. Without straining the right bezel brace, tilt it up slightly and use a jeweler's flat-blade screwdriver to carefully pry up the antenna receptor.

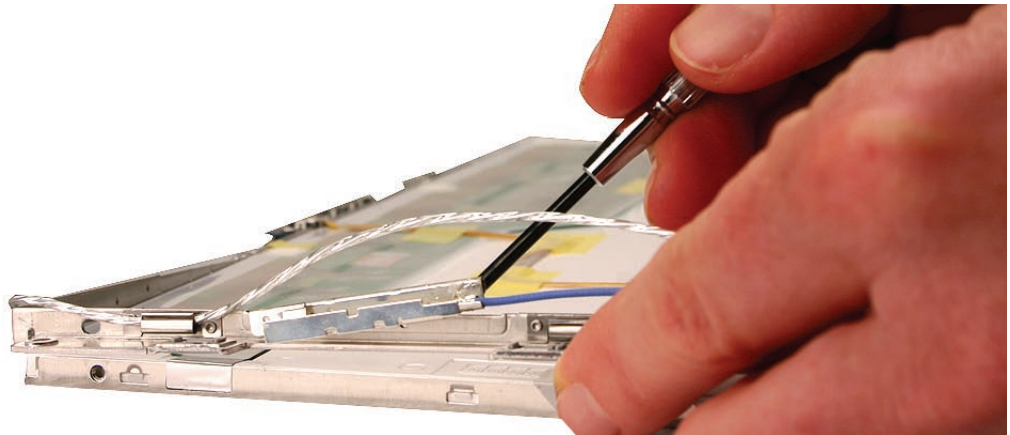

Important: To support the solder joint where the cable meets the receptor, keep the antenna cable in the last brace tab while loosening the receptor from the brace.

Caution: The antenna receptor is friction-fit with a metal fold that hooks onto the right brace. The antenna receptor is delicate and easily bent. Do not press on nor pinch the antenna receptor.

Replacement Note: Secure the antenna receptor by placing it over the recessed brace area and pressing only on the metal fold. You will hear an audible snap when it is installed.

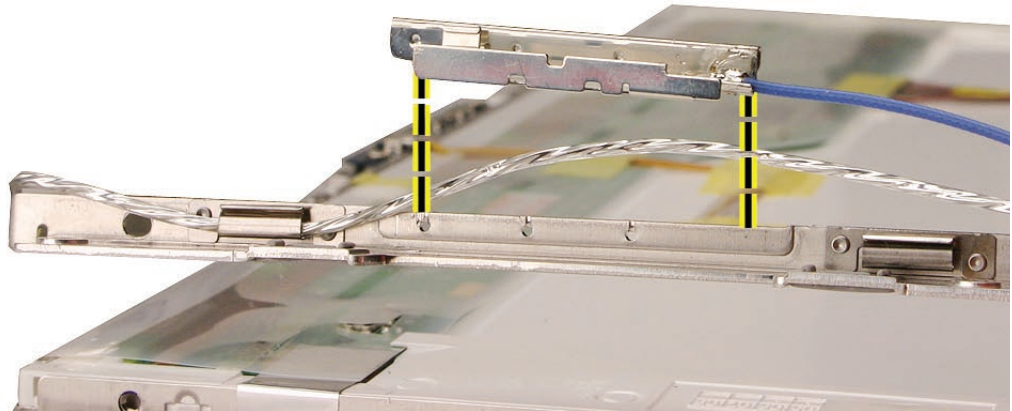

11. Install the replacement blue antenna cable, and reassemble and test the computer.





LCD Panel Assembly

Important: Although the LCD panel assembly is not an available subassembly part, it must be removed to replace other display parts.

Tools

- Soft cloth
- ESD wrist strap and mat
- Magnetic Phillips #0 screwdriver
- Black stick (Apple probe tool, part number 922-5065) or other nonconductive nylon or plastic flatblade tool

Preliminary Steps

Before you begin, remove

- Battery
- RAM door
- Top case with keyboard
- Optical drive
- Display module
- Display bezel
- Clutch cover
- Spacers at bezel scoops
- Bezel scoops
- Inverter board

Part Location



Removal Procedure

1. **Important:** Study the cable routing around each hinge carefully. When reinstalling the LCD panel assembly for your first time, this can be a tricky area

Note: Although the images show the inverter board installed, it should be removed previously as listed in the preliminary steps.

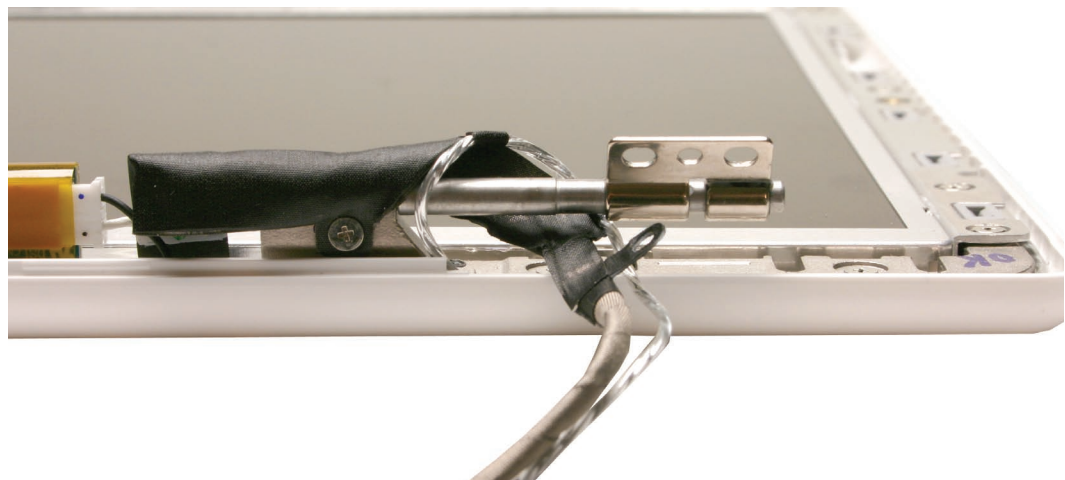
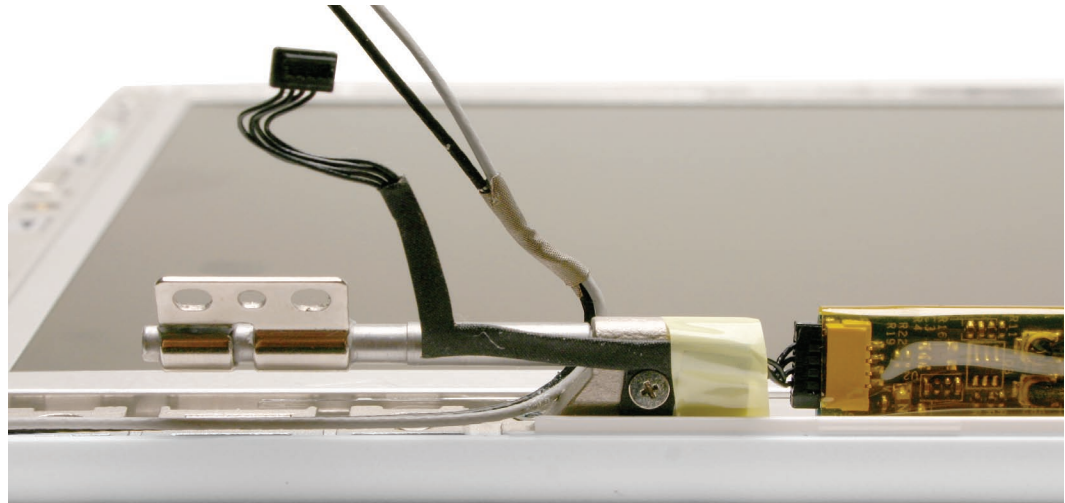

-
2. Following the order shown, remove the twelve identical 4.5-mm long screws around the frame of the LCD panel.

Caution: To prevent scratches or other cosmetic damage to the display housing, use a soft cloth as a protective layer when removing the screws.

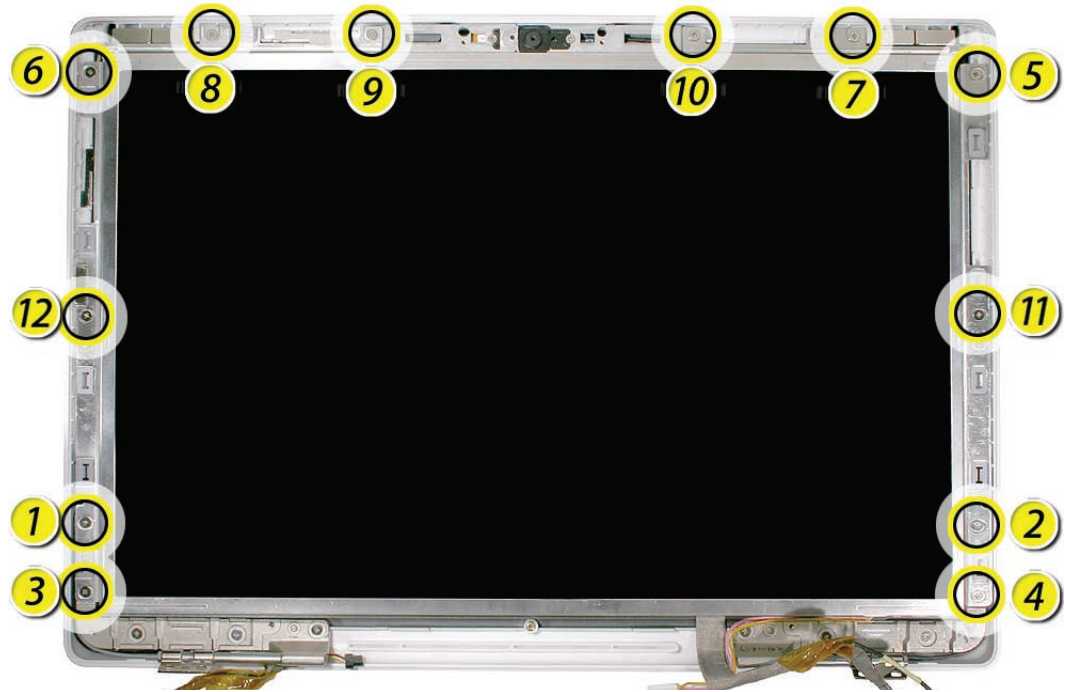

3. Remove the 3-mm long ground screws from the display hinges.
Note: Although the images show the inverter board installed, it should be removed previously as listed in the preliminary steps.

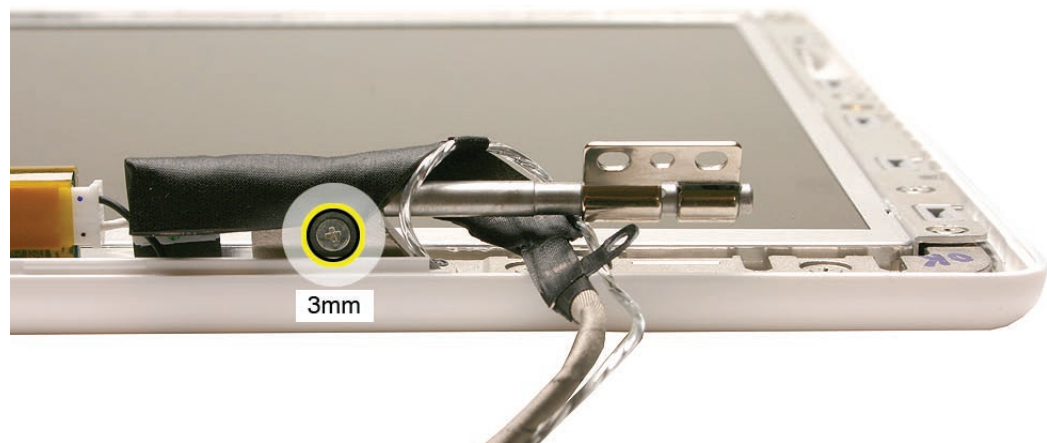
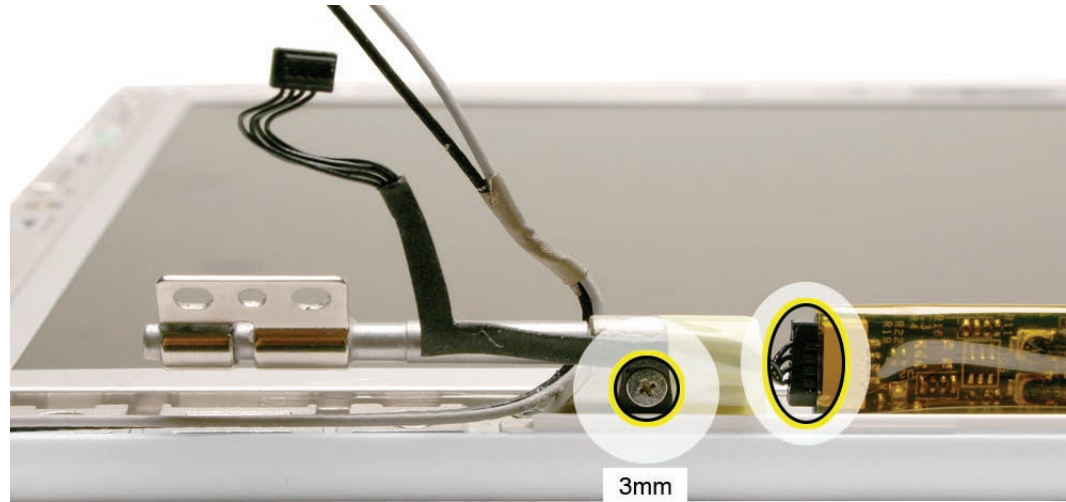

- Starting at the bottom corners, lift the LCD panel with frame and attached cables off of the display rear housing.

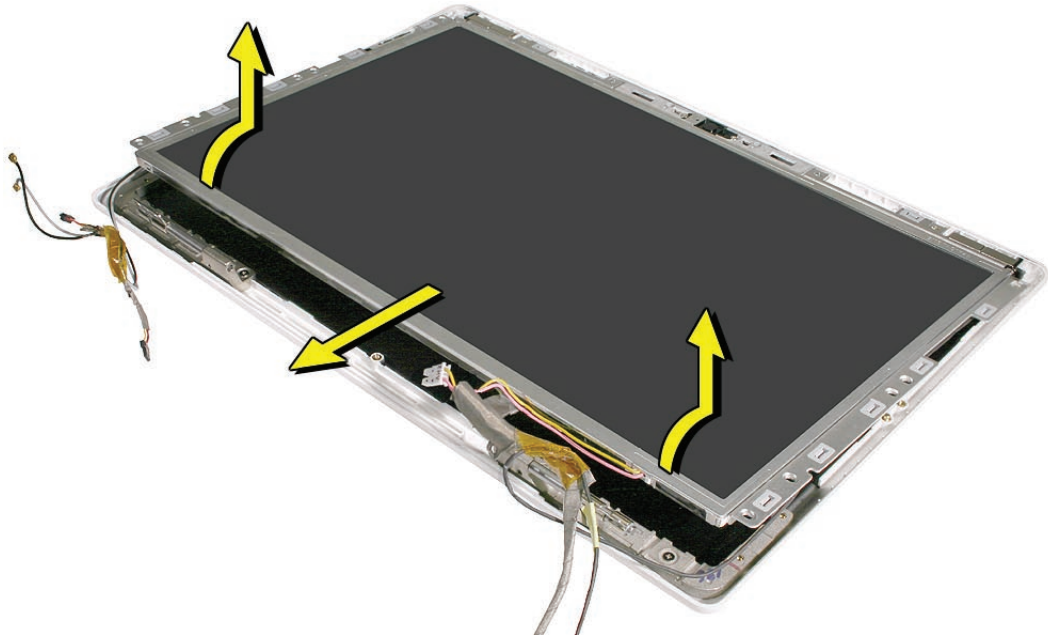

Note: The top of the camera bracket includes four thin, clear strips of double-sided tape. These are the camera spacers that are discussed later in this chapter. Be sure to reinstall them if they become loose.



Note: The magnets located in the display rear housing may come loose while lifting out the LCD panel assembly from the display rear housing. Don't lose the magnet pairs (on top corners) that function as the latch.

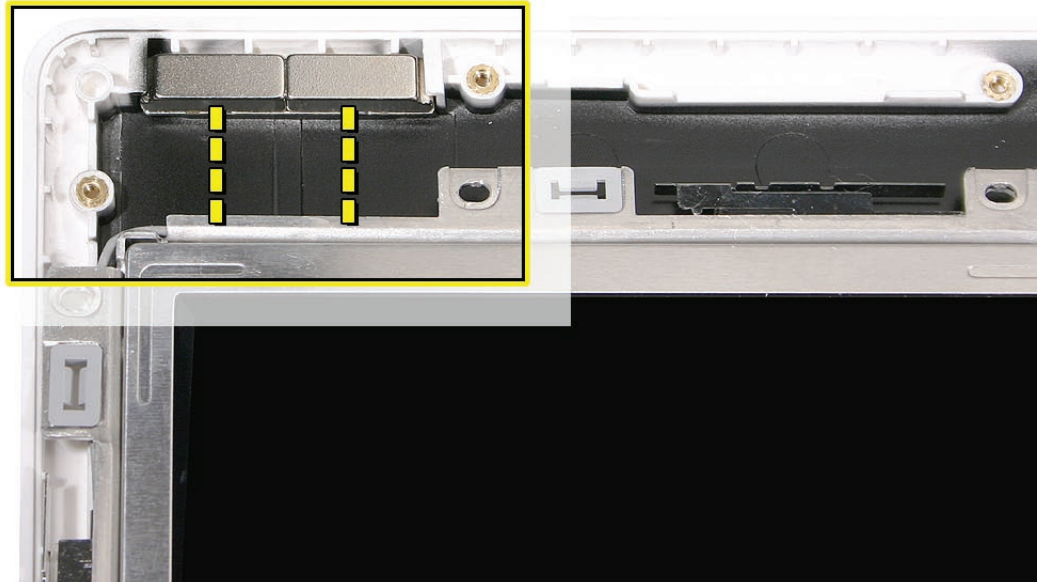

5. Set aside the LCD panel assembly so that the display is face-up if you are replacing any of its parts or any parts remaining in the display rear housing.
6. Reinstall the LCD panel assembly as follows.

Reinstallation Procedure

Important: Correctly positioning the LCD panel assembly in the display rear housing requires careful attention to these areas:

- Delicate antenna receptors
- Magnets that catch on the bezel brace
- Cables to route properly
- Locator pins on display rear housing

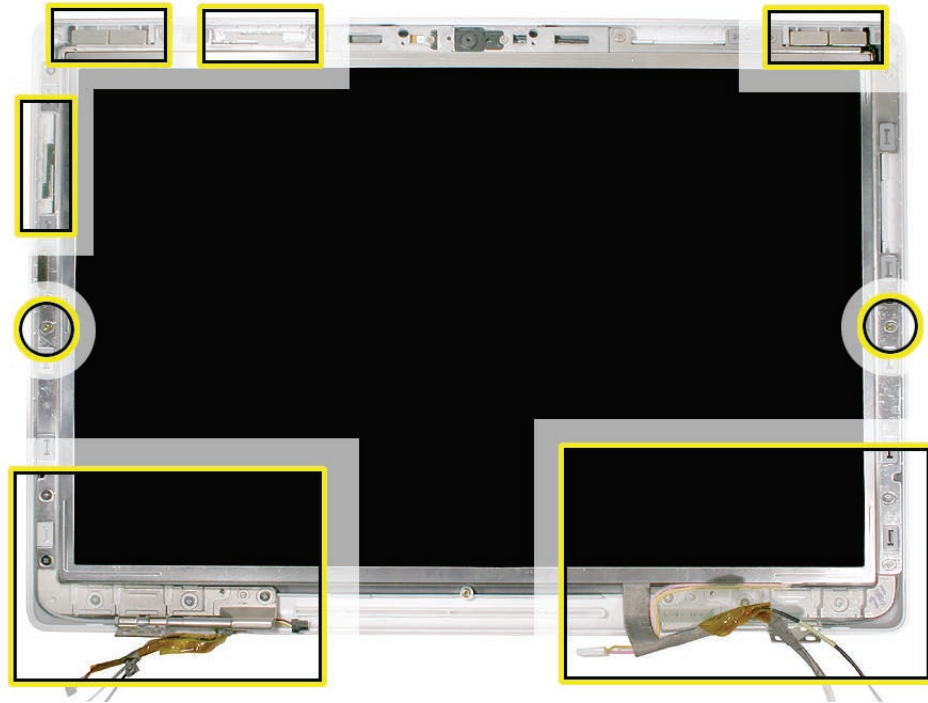

Caution: Hold the LCD panel assembly at the bezel brace sides or opposite corners. Do not press or pinch the antenna receptors or anywhere on the LCD panel itself.

1. Check the underside of the LCD panel assembly to make sure all cables are connected and routed properly:
 - LVDS cable
 - USB line to camera board
 - Black and gray antenna receptor cables
 - Microphone cable

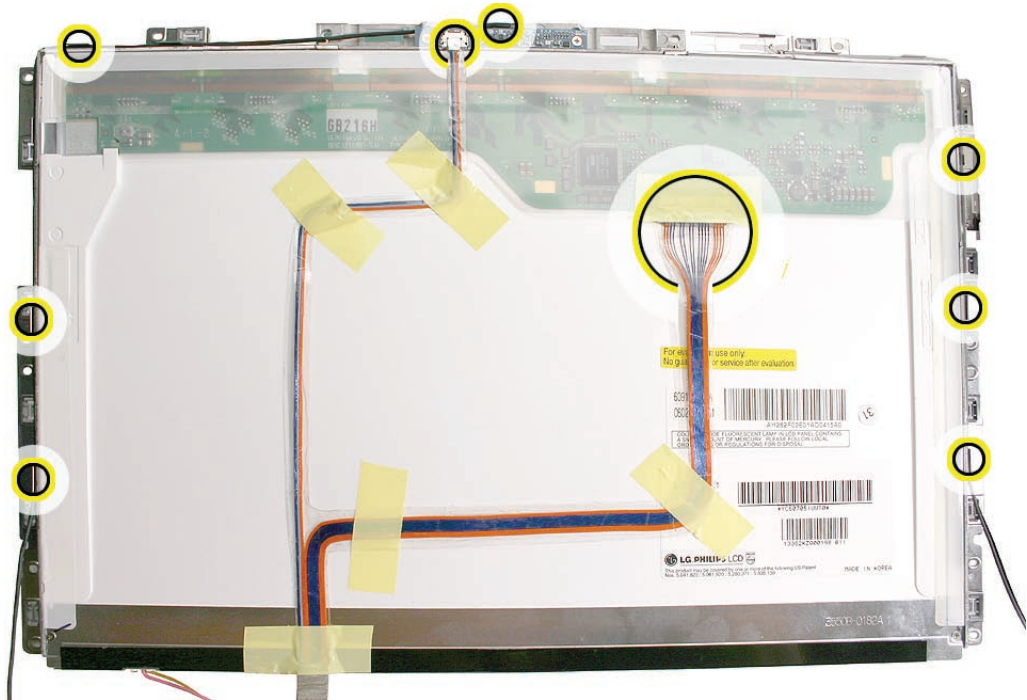

2. Check the display rear housing to make sure it includes the three magnets:
 - Sleep magnet on side
 - Two magnet pairs on top



3. **Important:** Insert the top corners of the LCD panel assembly into the display rear housing first. Use the notch in each bezel brace to help hold the cables in position. Then, before you

set the LCD panel assembly into the display housing, route the cables under the bezel brace between the housing and the display hinge.

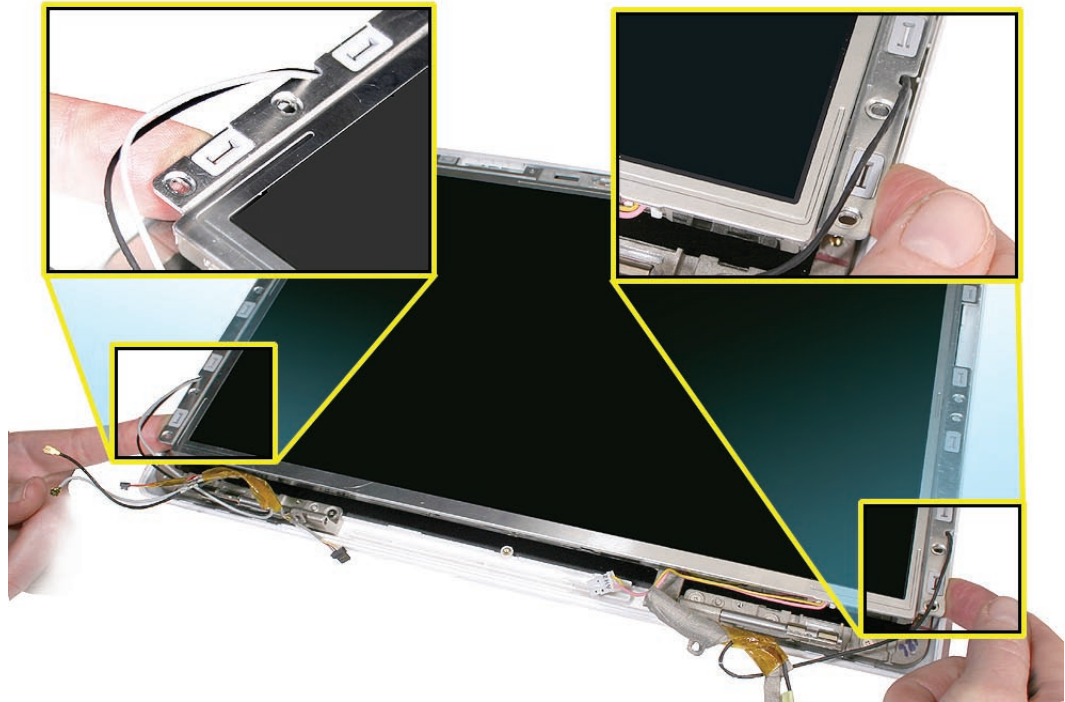

4. Set the magnets back into place if they come loose during this step.

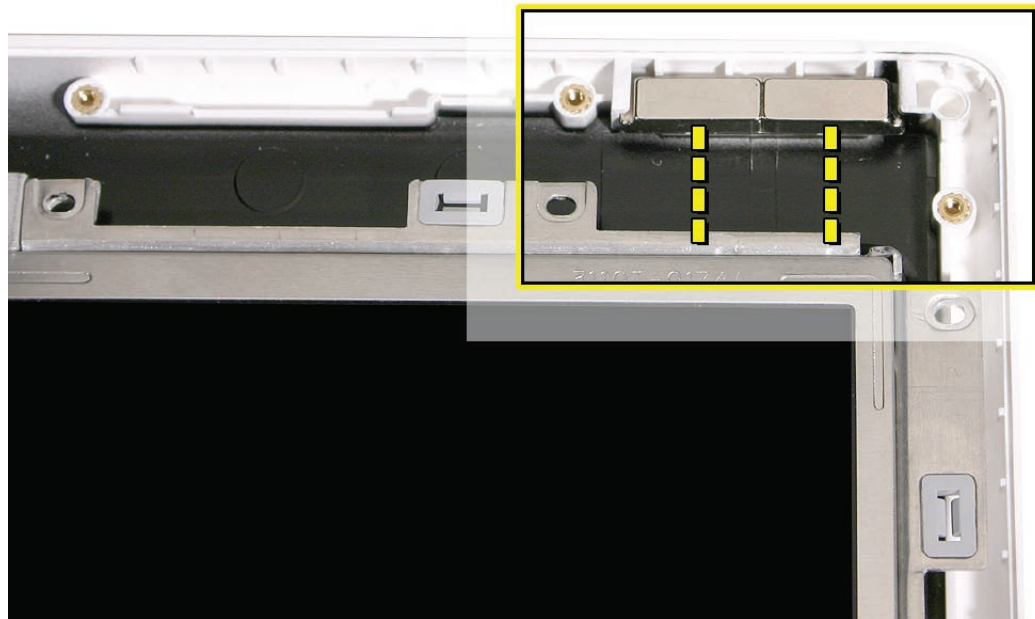

-
5. With the top corners secured, tilt up the bottom corners of the LCD panel assembly to route the antenna receptor cables and microphone cable around the recessed channel between the display hinge and the rear housing.



Important: The notch on each bezel brace indicates the point at which the cables start their path around the display hinge. Use a black stick at that notch to make sure the cables are not pinched and to guide them into the recessed channel.



6. Carefully pull the cables to make sure there is no slack as they route through the channels.



-
7. At the lower left corner, make sure the cables are routed as shown:
- Microphone cable routes along the outer edge of the bezel brace
 - LCD panel cable tucks under LVDS cable
 - LVDS cable routes around clutch barrel and secures microphone cable with two integral adhesive strips



8. With the magnets and cables in place, slightly reposition the LCD panel assembly, if necessary, so that the bezel braces fit over the two locator pins (one pin at each side of the rear housing).



9. Starting with the screw holes just above the locator pins, install the 12 screws in the order shown:
Caution: To prevent scratches or other cosmetic damage to the computer housing, use a soft cloth as a protective layer when installing the screws.

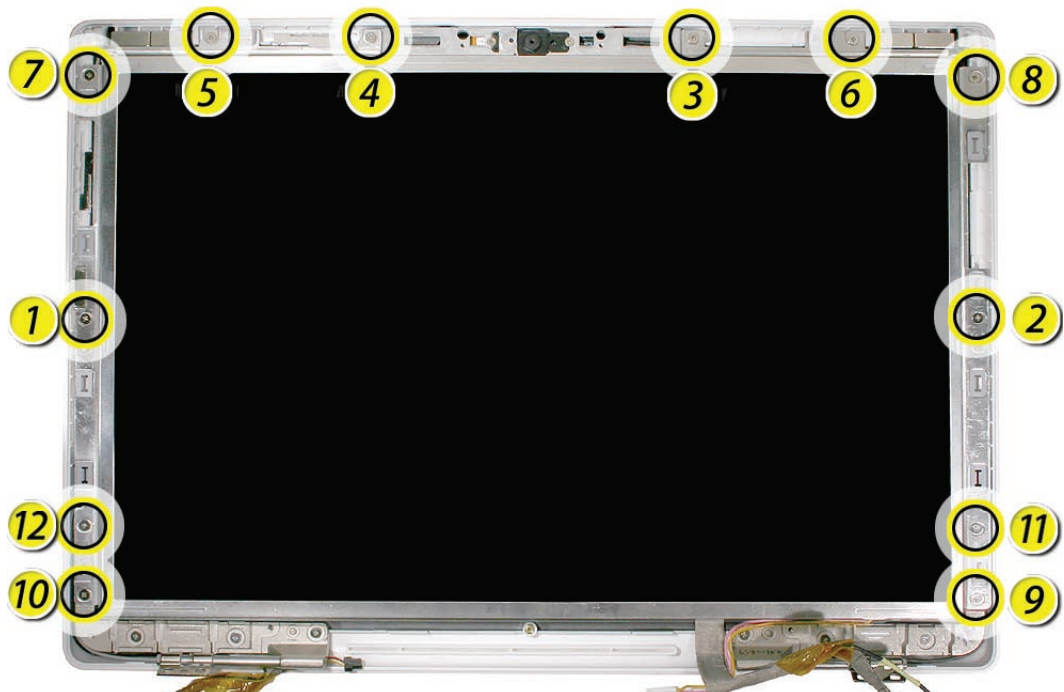

10. Reassemble and test the computer.



Foil at Camera Bracket

Tools

- Soft cloth
- ESD wrist strap and mat
- Black stick (Apple part number 922-5065) or other nonconductive nylon or plastic flatblade tool

Preliminary Steps

Before you begin, remove

- Battery
- RAM door
- Memory cards
- Hard drive
- Top case with keyboard
- Optical drive
- Display bezel
- Display module
- Clutch cover
- Inverter
- LCD panel assembly

Part Location

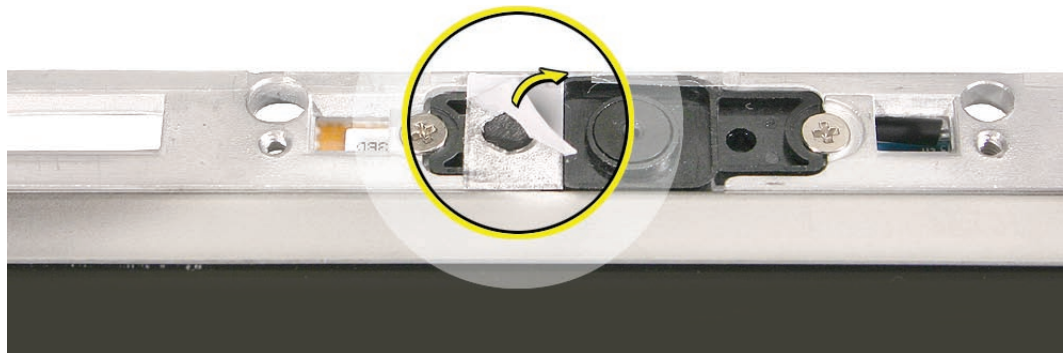

Procedure

1. Note the placement of the foil strip that attaches to the camera bracket with an adhesive backing.
2. Using a black stick, carefully peel up the foil strip.

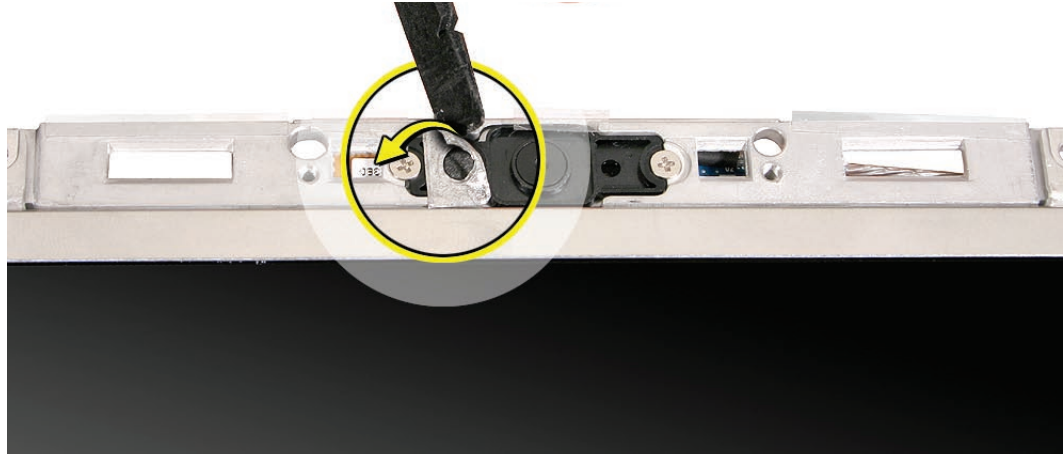

3. Position the replacement foil strip so that its round opening does not block any part of the round area for the microphone.

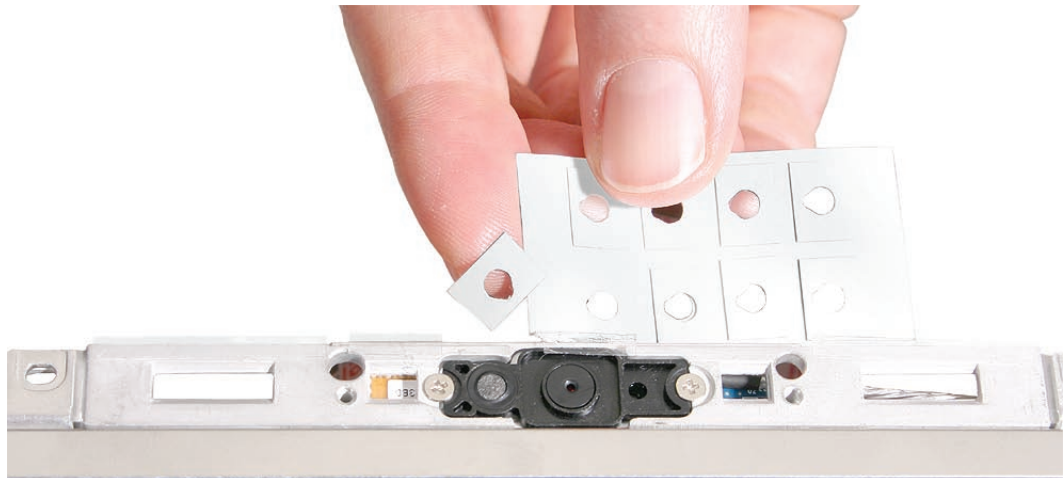

4. Lightly tap down on the foil so it adheres completely to the camera bracket..

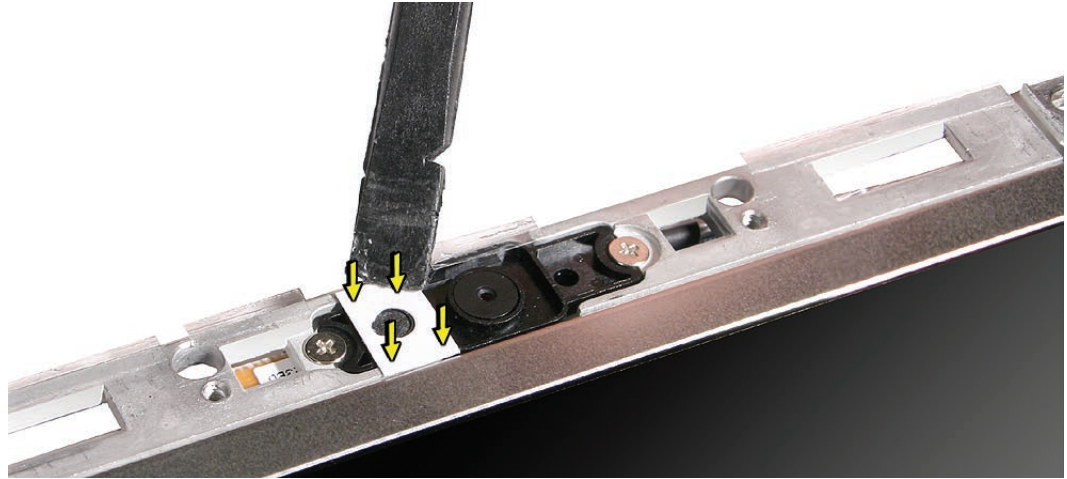

5. Peel up the adhesive paper so that the foil remains on the camera bracket.

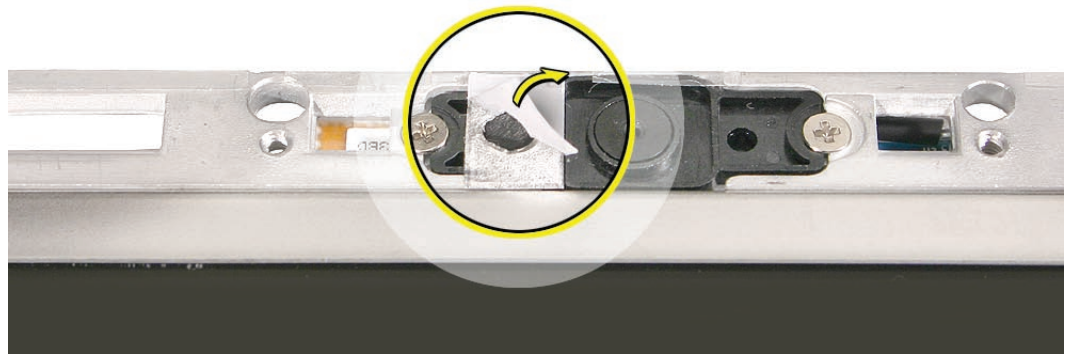

6. Reassemble and test the computer.



Spacers at Camera Bracket

Tools

- Soft cloth
- ESD wrist strap and mat
- Black stick (Apple part number 922-5065) or other nonconductive nylon or plastic flatblade tool

Preliminary Steps

Before you begin, remove

- Battery
- RAM door
- Memory cards
- Hard drive
- Top case with keyboard
- Optical drive
- Display bezel
- Display module
- Clutch cover
- Inverter
- LCD panel assembly

Part Location



Procedure

1. Note the placement of the four thin, clear strips that attach to the camera bracket with double-sided adhesive.
2. Using a black stick, remove the four strips.



Replacement Note: Position the replacement adhesive strips so that they extend slightly over the camera bracket but do not overlap the outer edge of the display rear housing.



3. Install the replacement camera spacers, and reassemble and test the computer.



Camera Assembly

Tools

- Soft cloth
- ESD wrist strap and mat
- Magnetic Phillips #0 screwdriver
- Black stick (Apple part number 922-5065) or other nonconductive nylon or plastic flatblade tool

Preliminary Steps

Before you begin, remove

- Battery
- RAM door
- Memory cards
- Hard drive
- Top case with keyboard
- Optical drive
- Display bezel
- Display module
- Clutch cover
- Inverter
- LCD panel assembly
- Spacers at camera bracket

Part Location

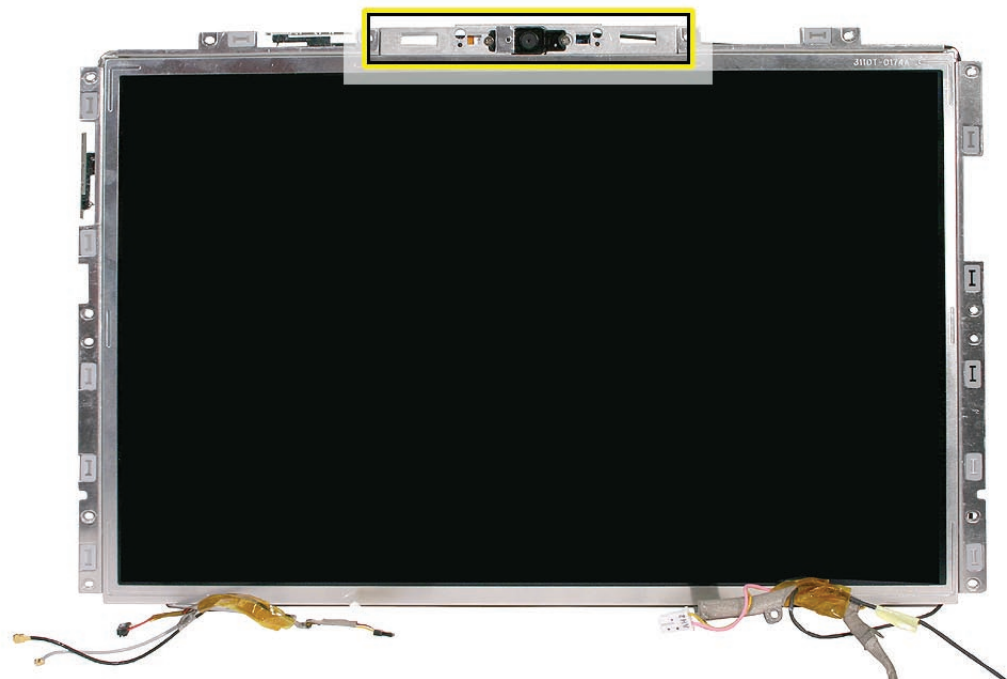

Procedure

1. With the LCD panel face-down on a clean, soft cloth, disconnect the USB camera cable (pull the connector straight down).
2. Remove the two 2-mm long screws from the camera board.

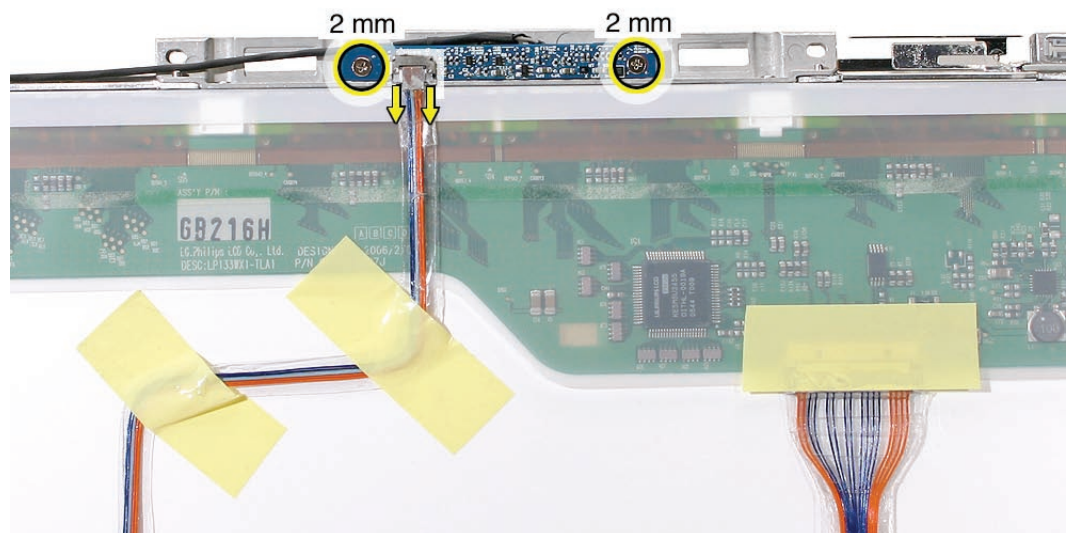

3. Tilt up the camera board and use a black stick to gently pry up the microphone cable gasket from the panel frame.

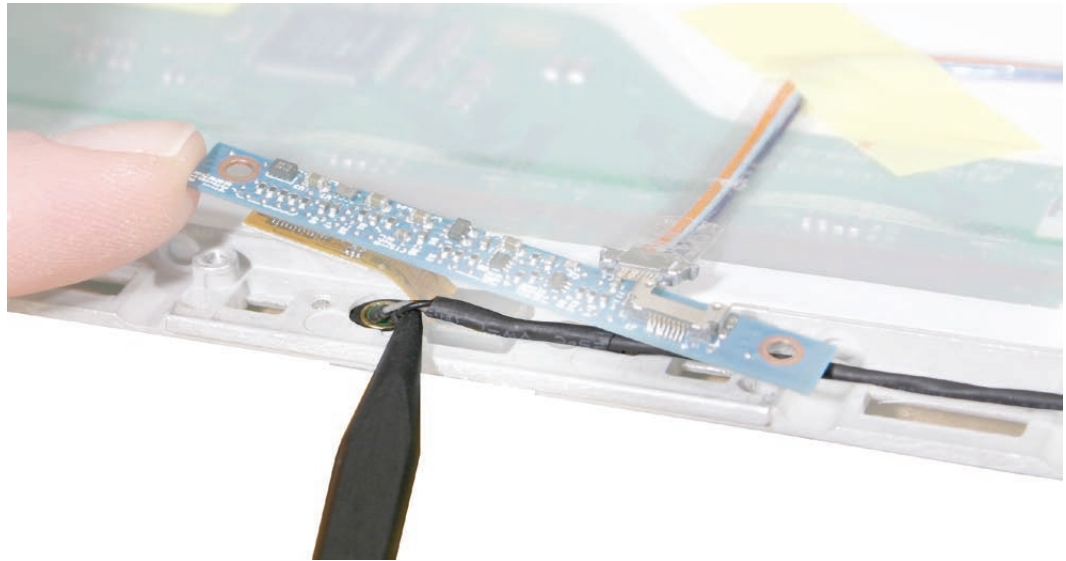

Replacement Note: Make sure the microphone gasket fits snug in the frame and that the microphone cable runs along the top of the camera frame before installing the screws.

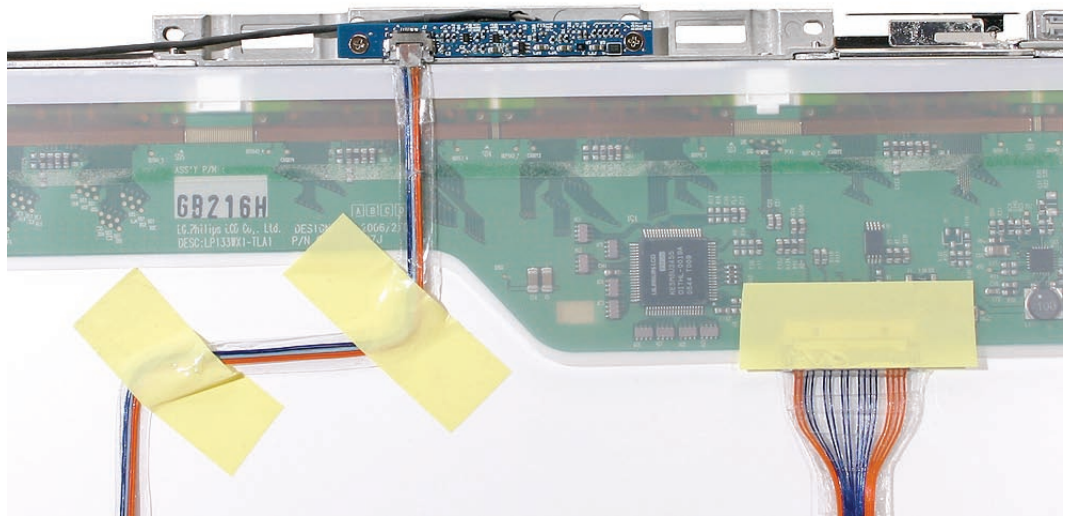

4. Peel up the single strip of tape that holds the microphone cable in place at the camera bracket.

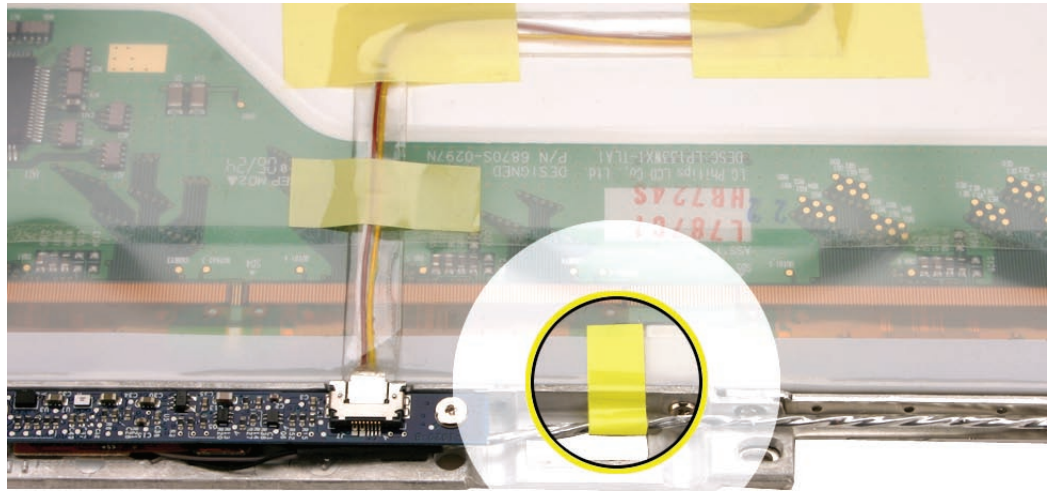

Replacement Note: Be sure to install a replacement strip of tape to hold the microphone cable in place and keep the cable away from areas where it could be pinched when the panel is reinstalled. Make sure the tape wraps around to the front of the camera bracket.



5. Hold the LCD panel assembly upright so you can access the two 3-mm long screws that secure the camera bracket to the top of the LCD panel. Remove the two screws.

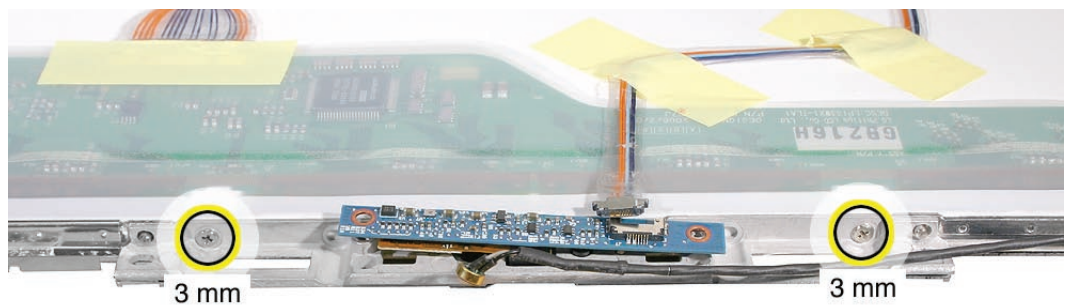

- Lift off the camera bracket from the locator pins on the bezel braces. Do not remove the camera board from the bracket.

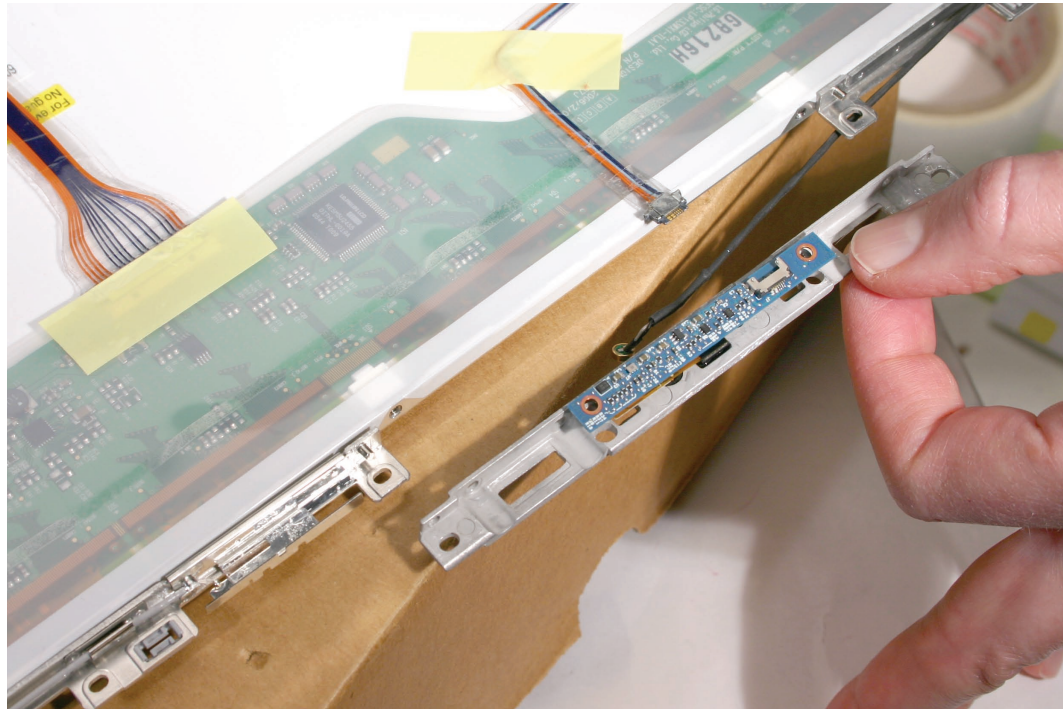

- Install the replacement camera assembly, and reassemble and test the computer.

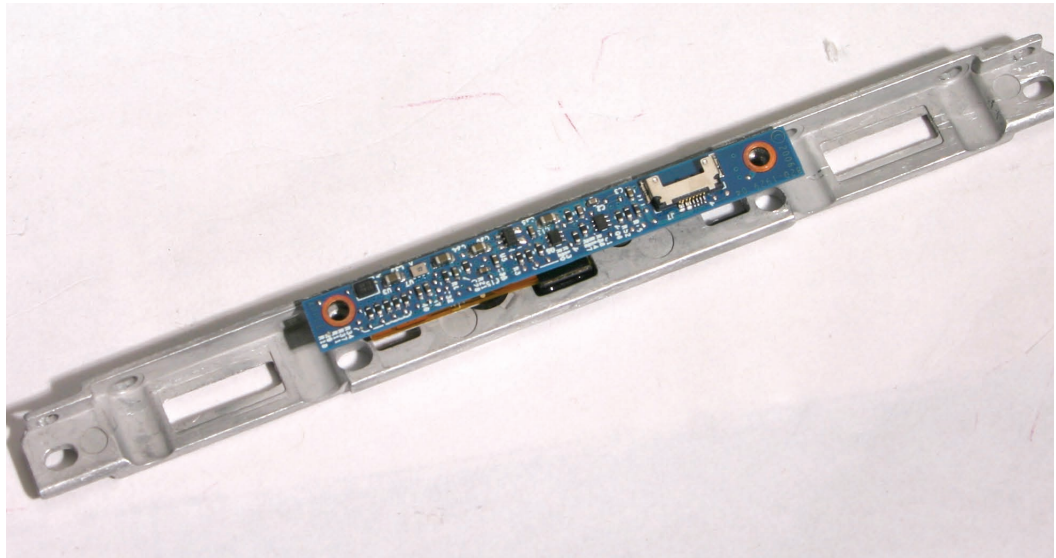

Replacement Note: The camera assembly includes:

- Camera bracket
- Camera board
- Camera in plastic case
- Flex cable from camera case to camera board
- Screws

Replacement Note: Be sure to reinstall the microphone in the gasket before securing the 2-mm long camera board screws.

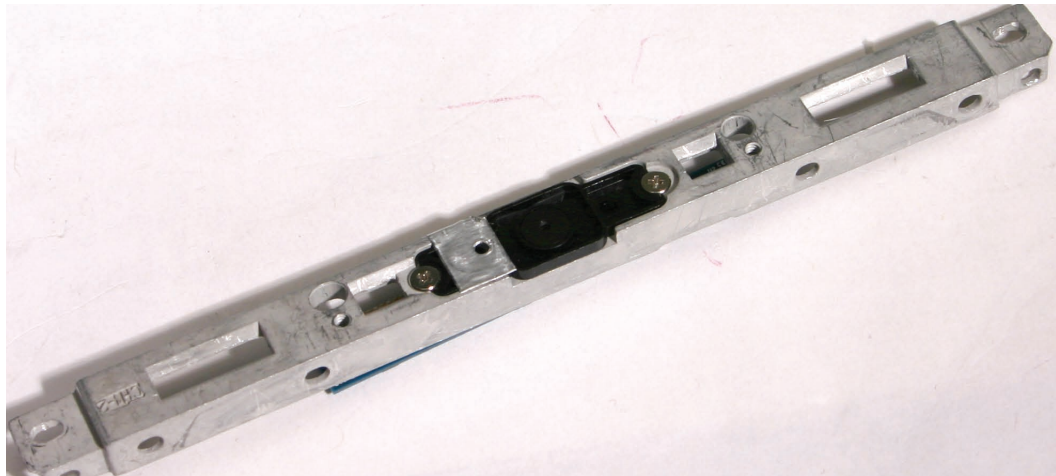

Replacement Note: When reinstalling the USB line, no copper contacts should be visible. Reinstall the cable if you can see copper contacts.

- Wrong

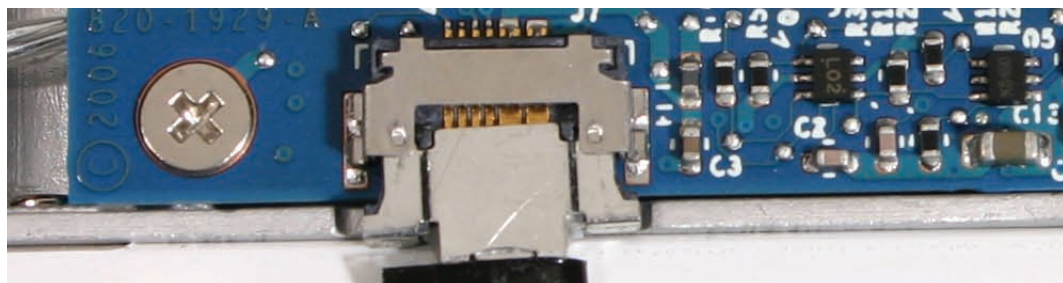

- Right

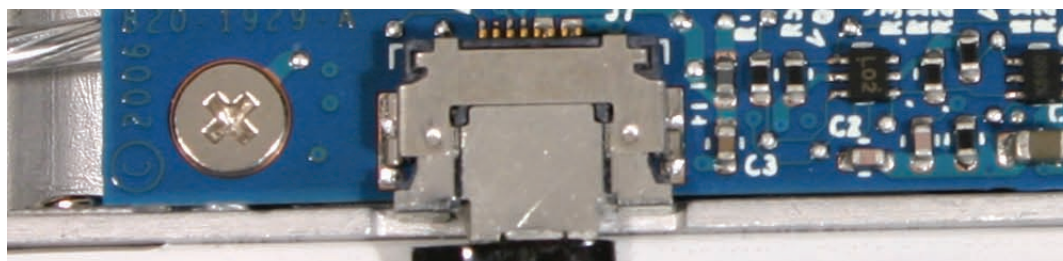



LVDS Cable with USB Line

Tools

- Soft cloth
- ESD wrist strap and mat
- Black stick (Apple part number 922-5065) or other nonconductive nylon or plastic flatblade tool
- Permanent marking, felt-tip pen

Preliminary Steps

Before you begin, remove

- Battery
- RAM door
- Top case with keyboard
- Optical drive
- C-channel
- Display bezel
- Display module
- Clutch cover
- Inverter board
- Spacers at bezel scoops
- Bezel scoops
- LCD panel assembly

Part Location

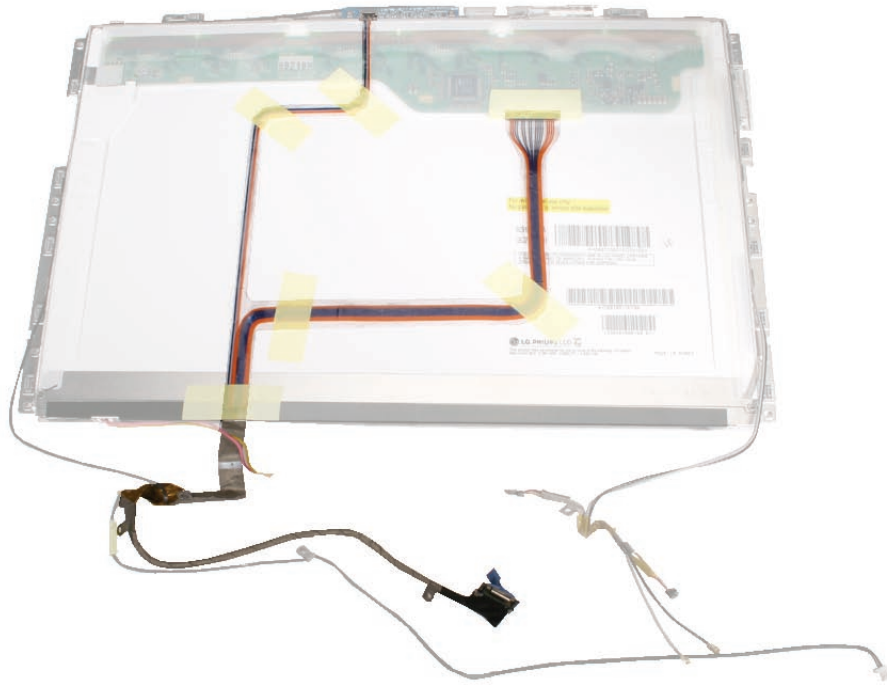

Procedure

1. Note the placement of the strips of tape that secure the LVDS cable and the USB line to the LCD panel.

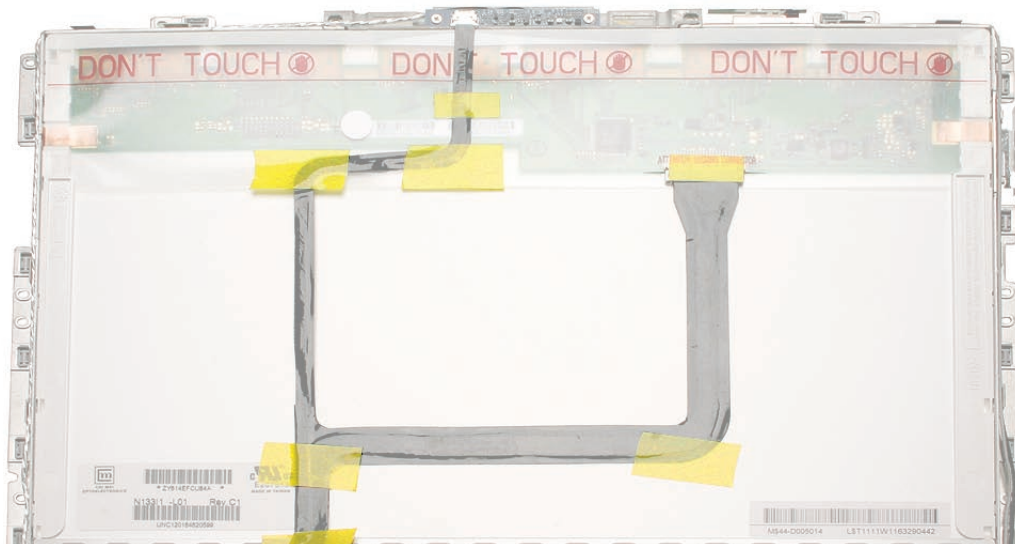

2. Because the protective sheath for the flex cables can be delicate, use light pressure to hold the cables in place as you carefully peel up the strips of tape just enough to free the cables.

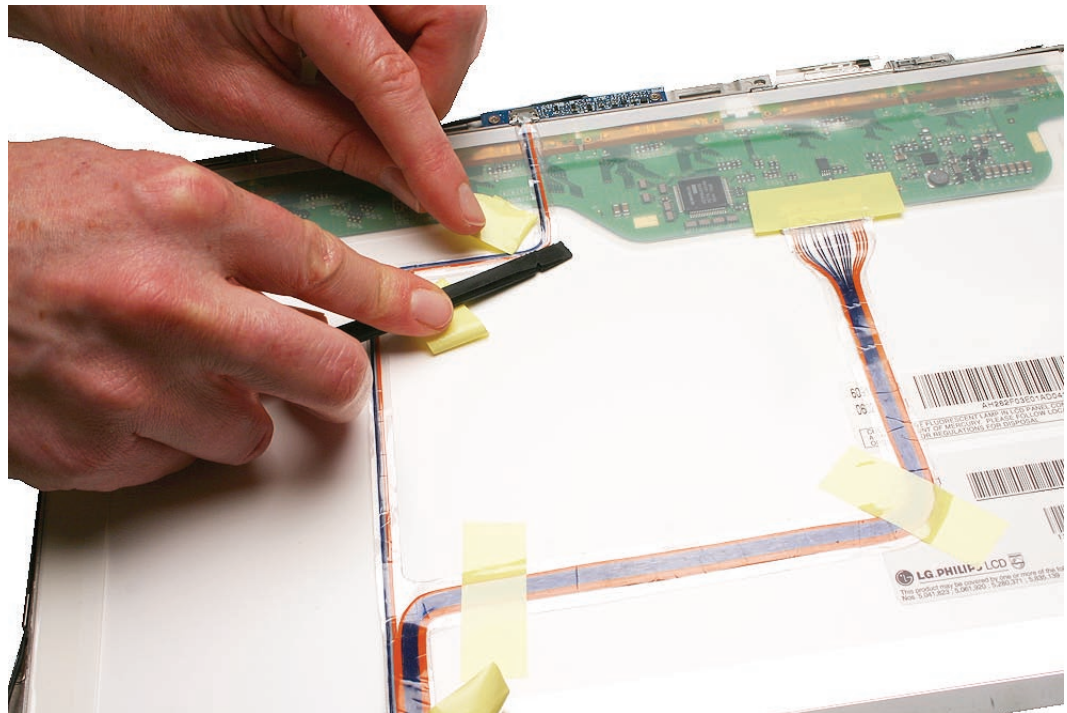

3. Disconnect the LVDS cable by pulling the connector straight down from the connector on the LCD panel.

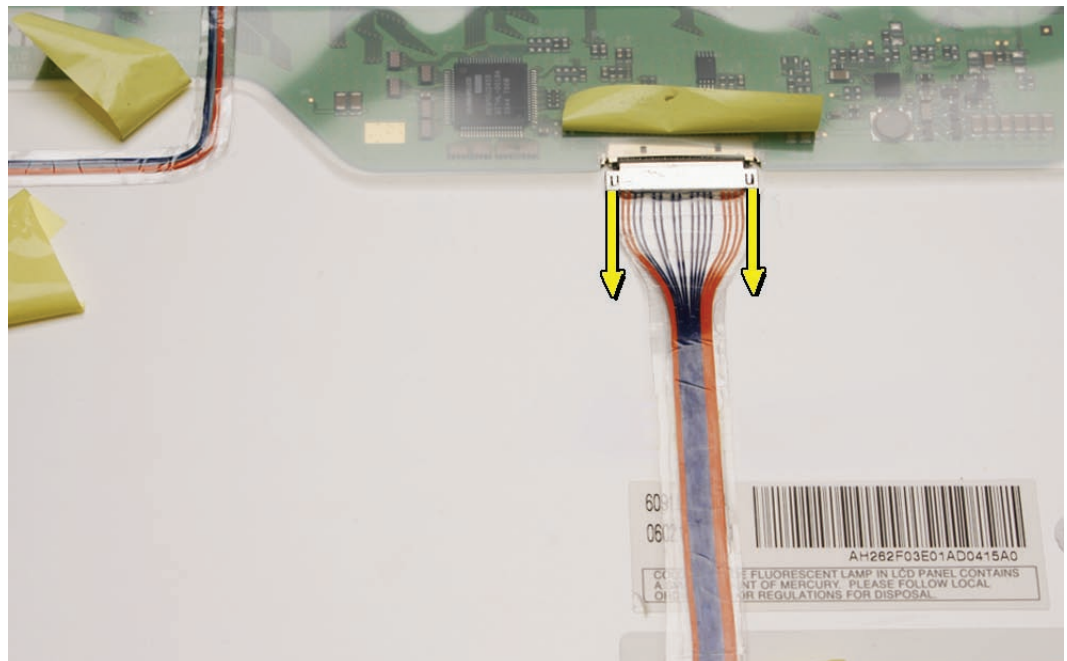

4. Disconnect the USB line by using a black stick and your fingernail to slide the connector straight down from the camera board.

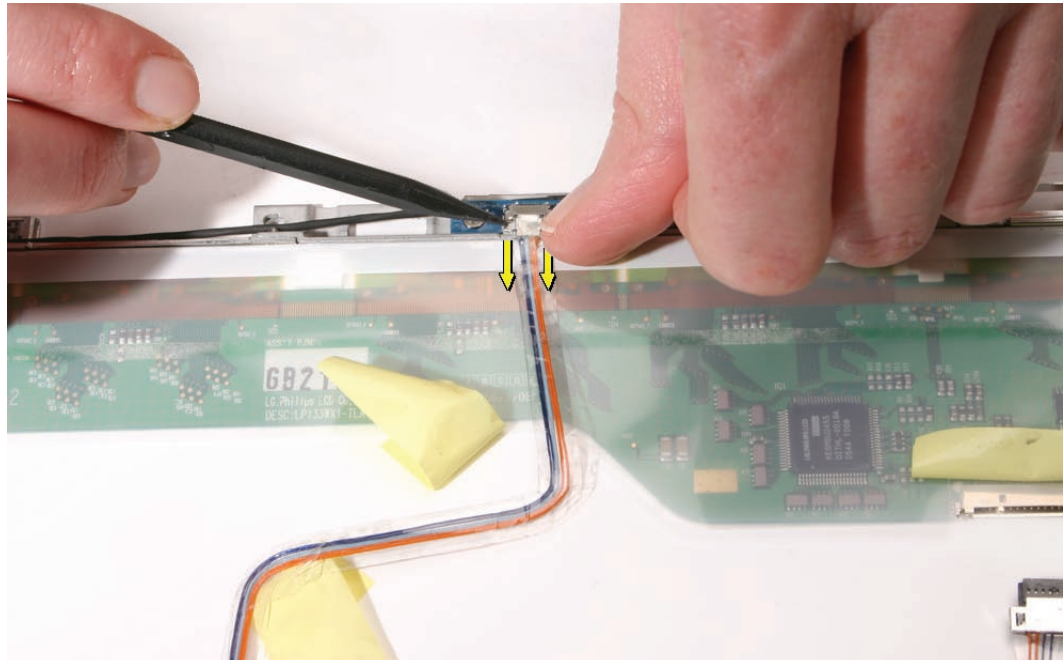

Replacement Note: When reinstalling the USB line, no copper contacts should be visible. Reinstall the cable if you can see copper contacts.

- Wrong

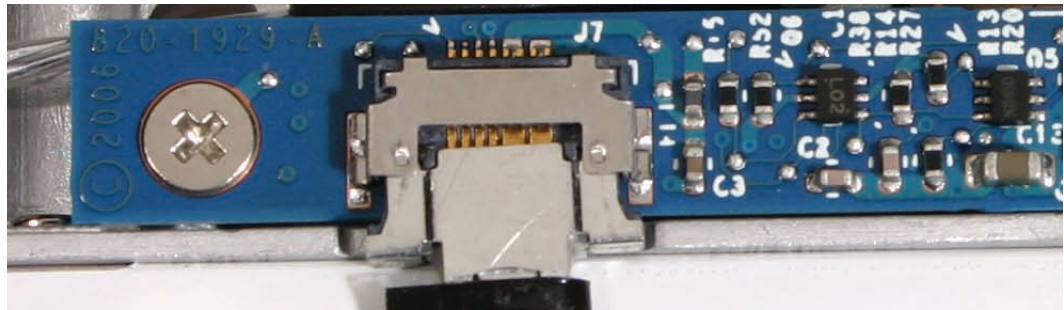

- Right

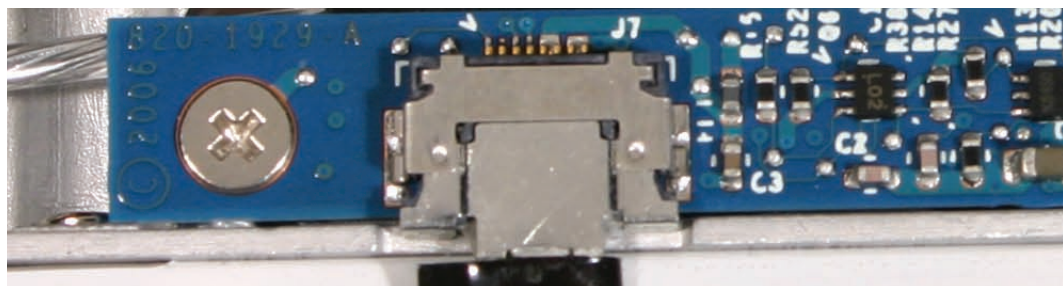

5. Remove the LVDS cable from the panel, and unwrap the black tape that secures the cable to the microphone cable.

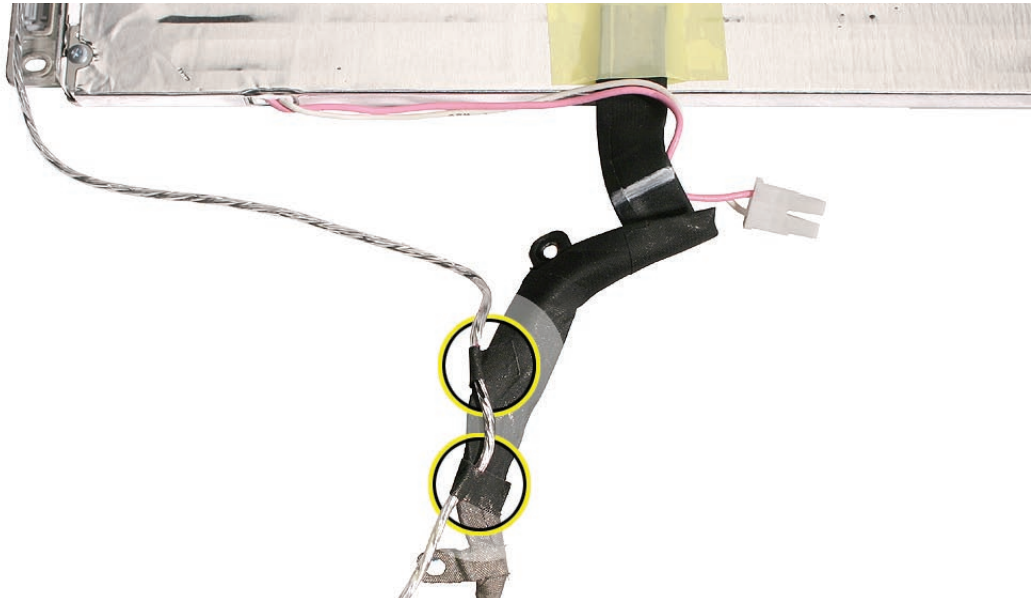

Replacement Note: Whenever the microphone cable is to be separated from the LVDS cable, use a permanent marking pen to mark the microphone cable. Marking the cable where the strips of conductive tape overlap the microphone cable provides a guide for reassembly.

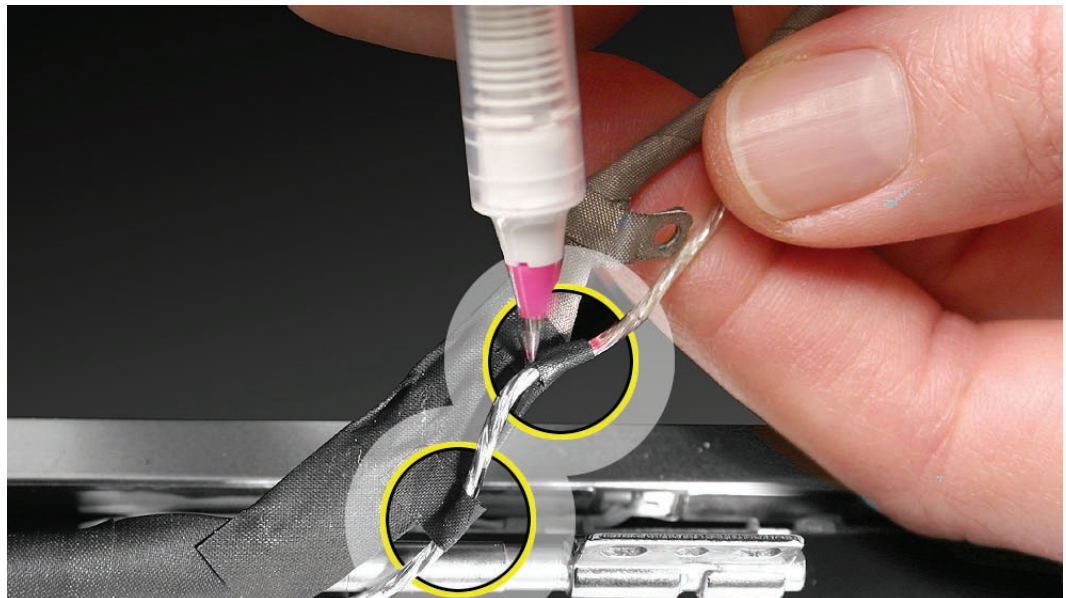



-
6. Install the replacement LVDS cable with USB line, and reassemble and test the computer.



Late 2006 Model Replacement Note: For the Late 2006 model, there are three possible panel manufacturers: AUO, Chi Mei, and Samsung. Refer to the following table when replacing the LVDS cable or LCD panel:

- If you are replacing just the LVDS cable but not the panel, be sure to check the LCD panel logo as shown in the table to order the appropriate LVDS cable (922-7889 or 922-7890).
- If you are replacing the LCD panel, be sure to also replace the LVDS cable and any conductive tape that comes bundled in the 661-4211 kit. (Do not order a separate LVDS cable.)

LCD Panel Logo	Display Part Number (a bundled kit that includes the LCD panel and LVDS cable)	Compatible LVDS Cable
AUO 	661-4211	922-7889
Chi Mei 	661-4211	922-7889
Samsung 	661-4211	922-7890



Microphone Cable

Tools

- Soft cloth
- ESD wrist strap and mat
- Magnetic Phillips #0 screwdriver
- Black stick (Apple part number 922-5065) or other nonconductive nylon or plastic flatblade tool
- Permanent marking, felt-tip pen

Preliminary Steps

Before you begin, remove

- Battery
- RAM door
- Top case with keyboard
- Optical drive
- C-channel
- Display bezel
- Display module
- Clutch cover
- Inverter board
- Spacers at bezel scoops
- Bezel scoops
- LCD panel assembly

Part Location

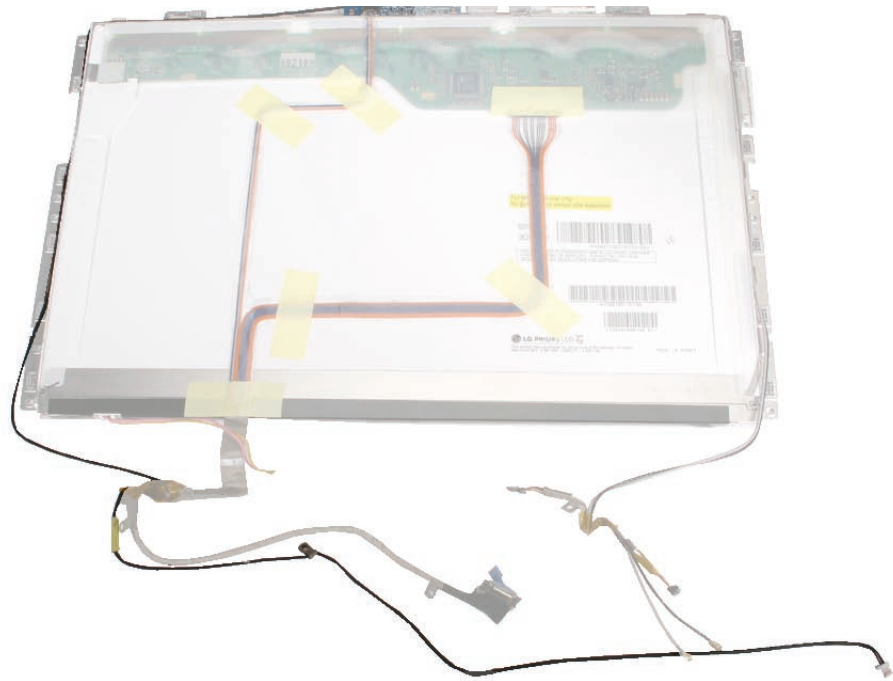

Procedure

1. Note the routing of the microphone cable as it runs along the right edge of the LCD panel.

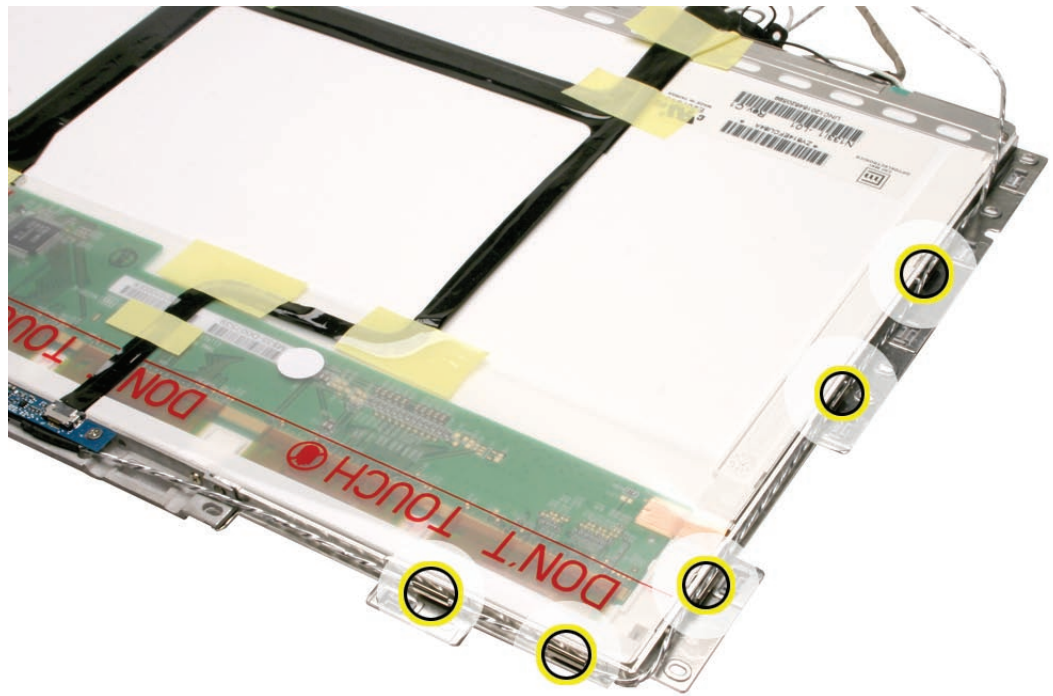

2. Pull up the cable from the routing tabs.

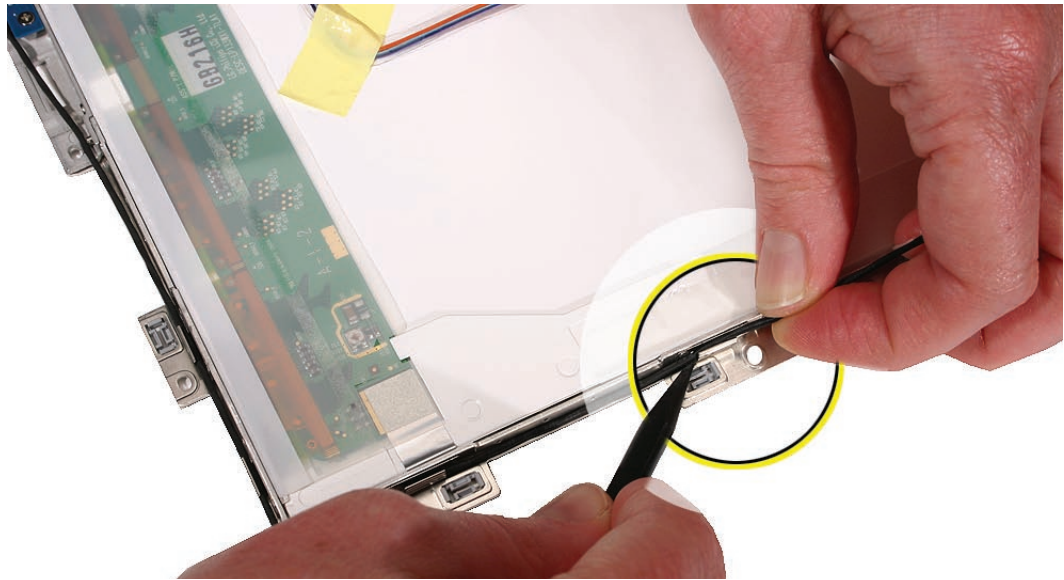

3. Peel up the single strip of tape that holds the microphone cable in place at the camera bracket.

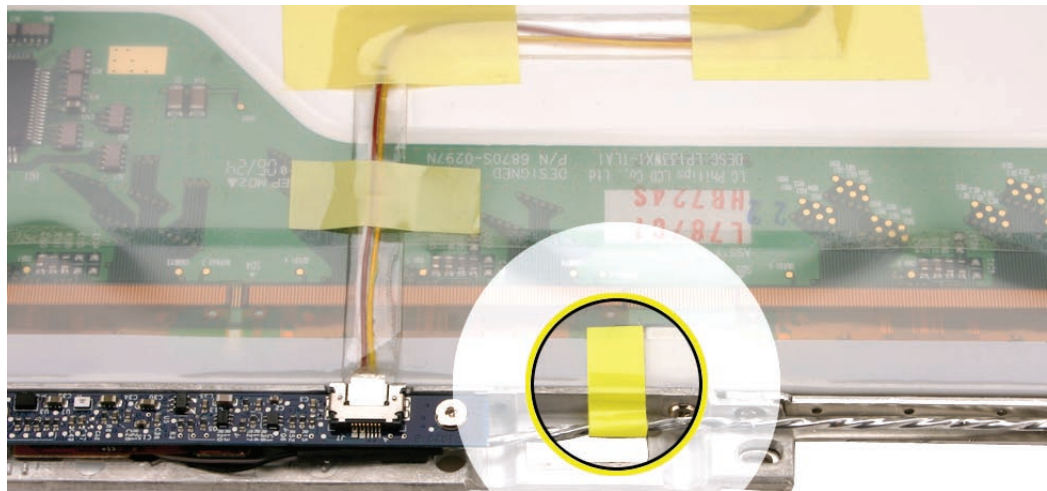

Replacement Note: Be sure to install a replacement strip of tape to hold the microphone cable in place and keep the cable away from areas where it could be pinched when the panel is reinstalled. Make sure the tape wraps around to the front of the camera bracket.



4. Remove the two 3-mm long screws from the camera board.

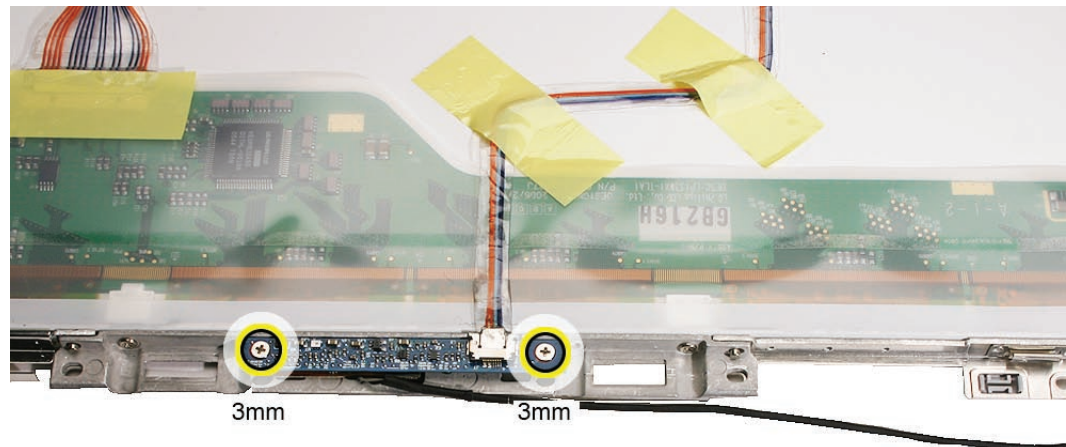

5. Without straining the camera board cable, carefully tilt up the camera board to access the microphone that is fitted into the opening in the camera bracket.

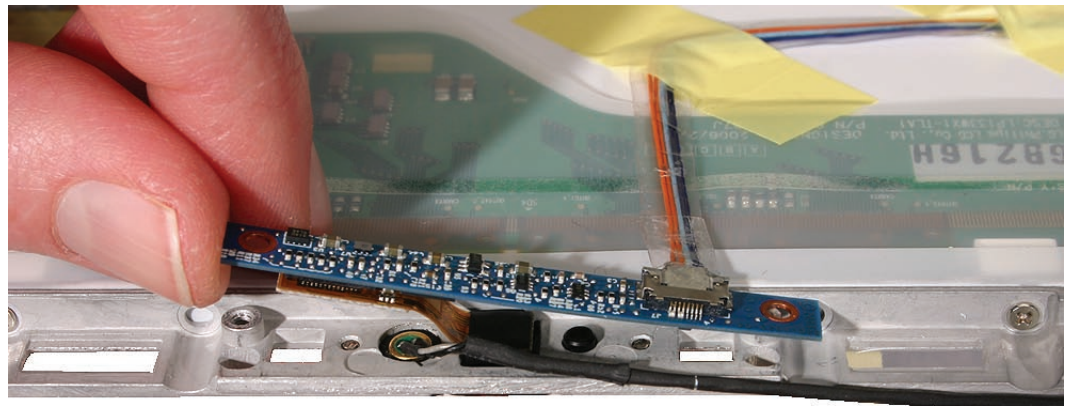

6. Use a black stick to pull up the microphone from the gasket.

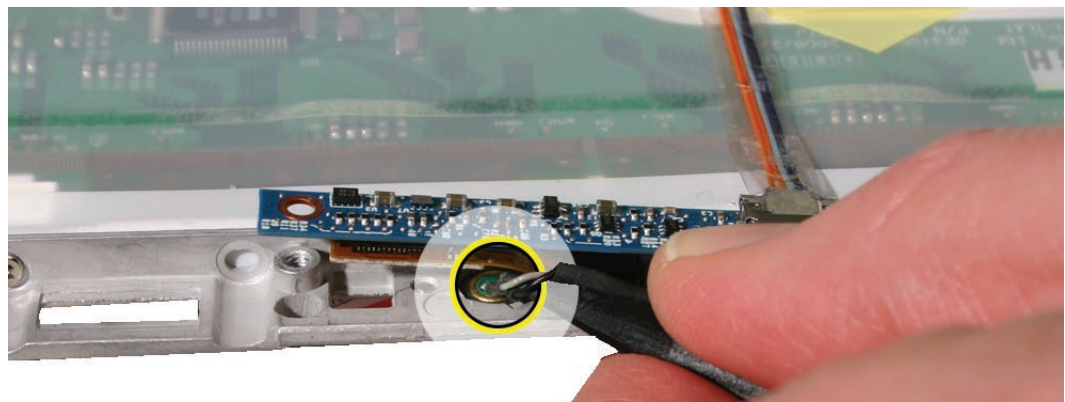

Replacement Note: Install the microphone in the gasket and use a black stick to press it down so it is level with the edge of the gasket.

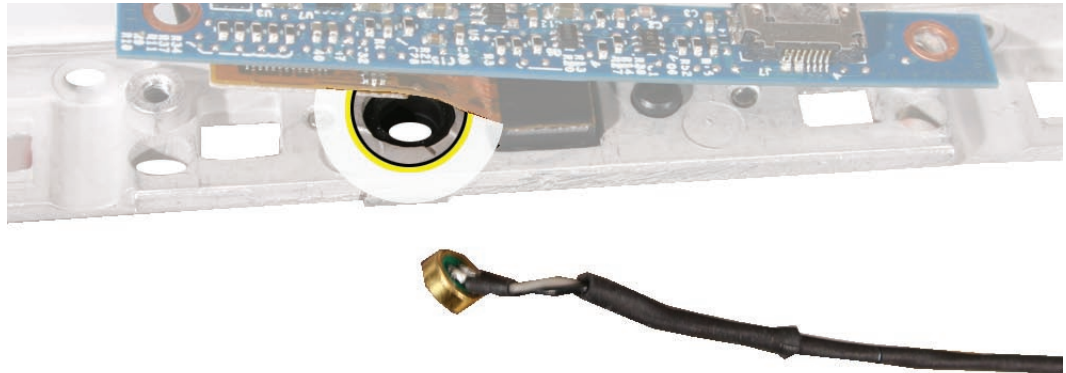

7. Unwrap the black tape that secures the microphone cable with the LVDS cable.

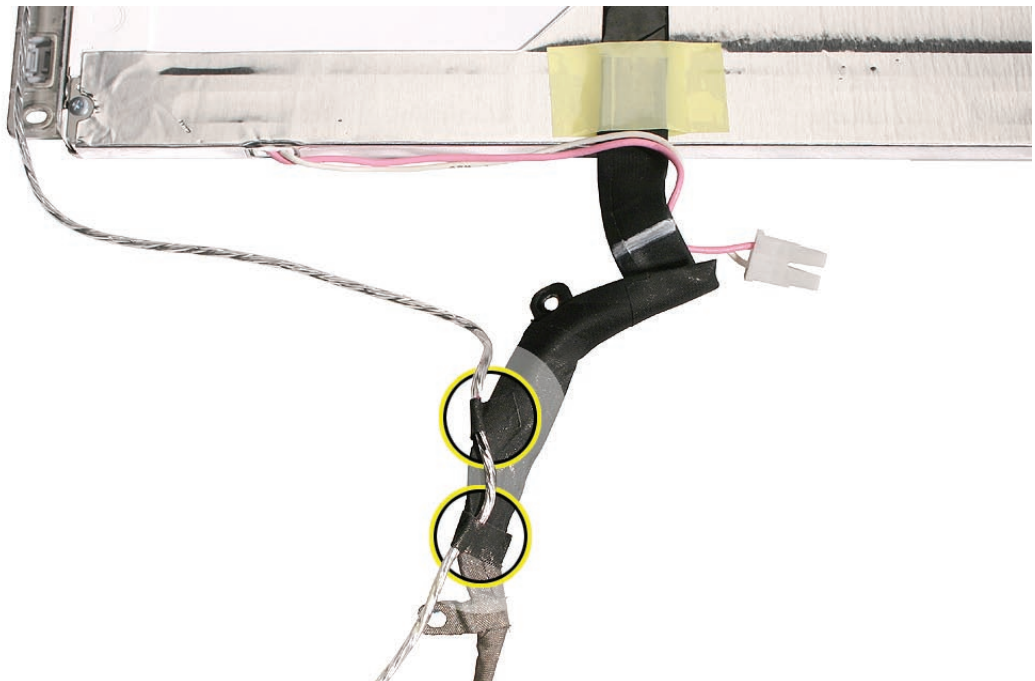

-
8. **Replacement Note:** Whenever the microphone cable is to be separated from the LVDS cable, use a permanent marking pen to mark the microphone cable. Marking the cable where the strips of conductive tape overlap the microphone cable provides a guide for reassembly.

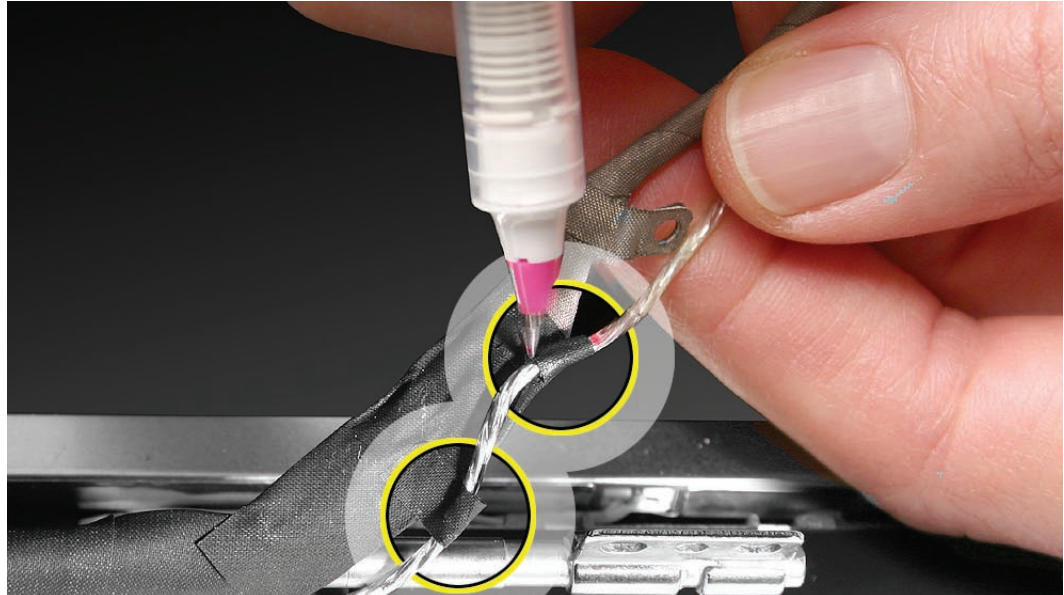

9. Install the replacement microphone cable, and reassemble and test the computer.

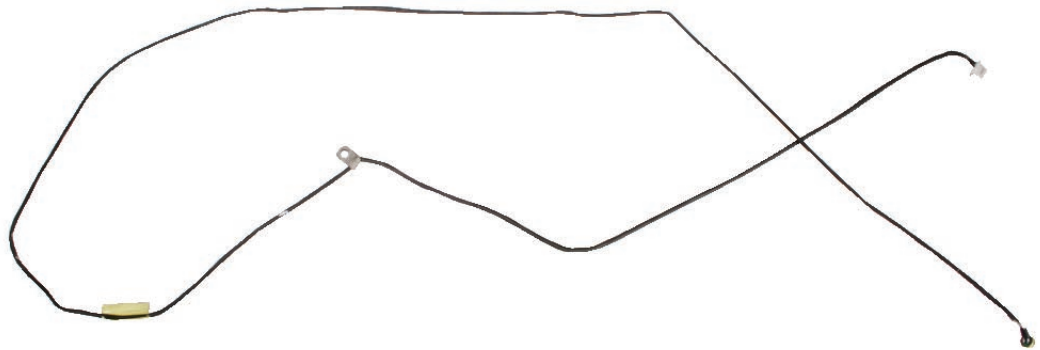

Important: Where the microphone cable exits the display rear housing, the microphone cable must be pulled taut within the cable bundle exiting the display. If it's too loose or too tight, it could get pinched during display reassembly.





Inverter Board

Tools

- Soft cloth
- ESD wrist strap and mat
- Black stick (Apple part number 922-5065) or other nonconductive nylon or plastic flatblade tool

Preliminary Steps

Before you begin, remove

- Battery
- RAM door
- Top case with keyboard
- Optical drive
- Display module
- Display bezel
- Clutch cover

Part Location



Procedure

Caution: During this procedure, do not press on the flat area of the board or on its components. Handle the board by the edges only.

1. Using a black stick or your fingers, disconnect the inverter cable from the left end of the board.

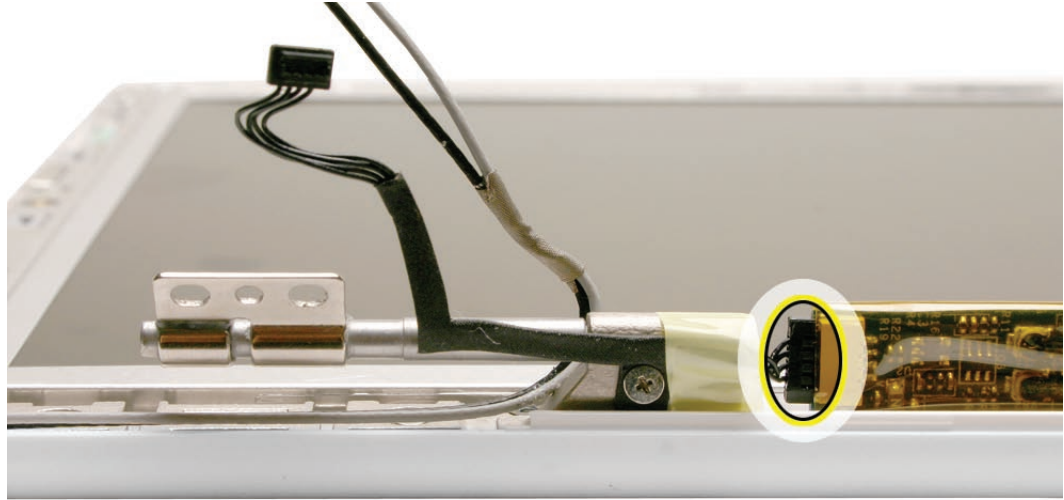

2. Disconnect the LCD panel cable from the right end of the board.

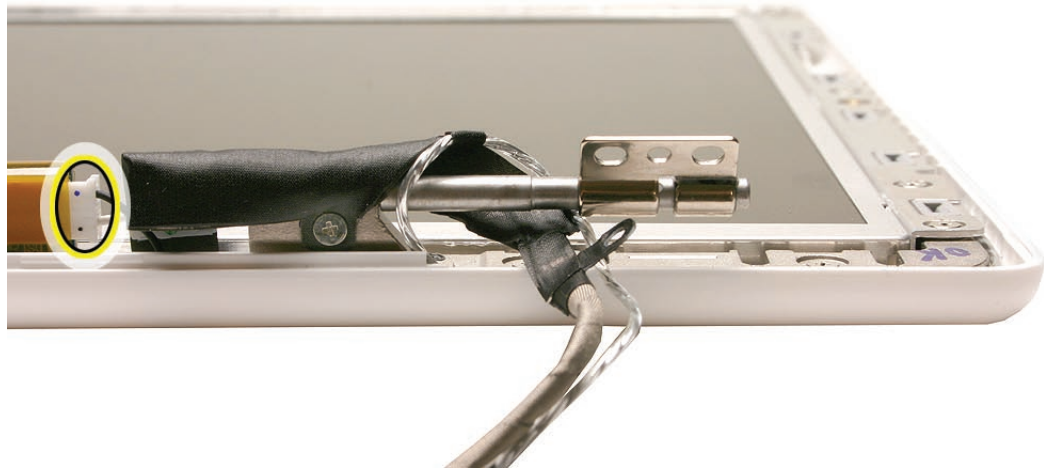

3. Holding the board by the ends, lift out the inverter board from the slot in the display rear housing.

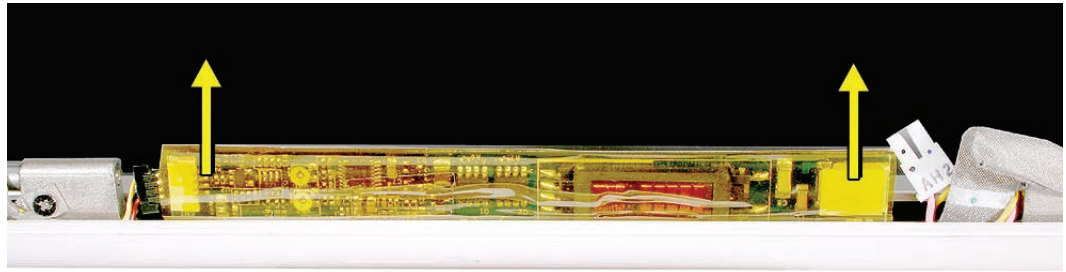

4. Install the replacement inverter board, and reassemble and test the computer.

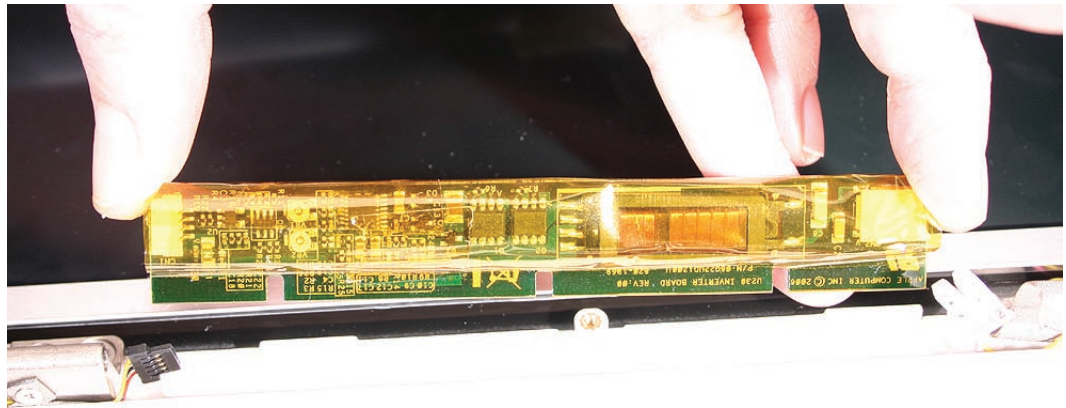



Inverter Cable

Tools

- Soft cloth
- ESD wrist strap and mat
- Black stick (Apple part number 922-5065) or other nonconductive nylon or plastic flatblade tool

Preliminary Steps

Before you begin, remove

- Battery
- RAM door
- Top case with keyboard
- Optical drive
- Display module
- Display bezel
- Clutch cover

Part Location

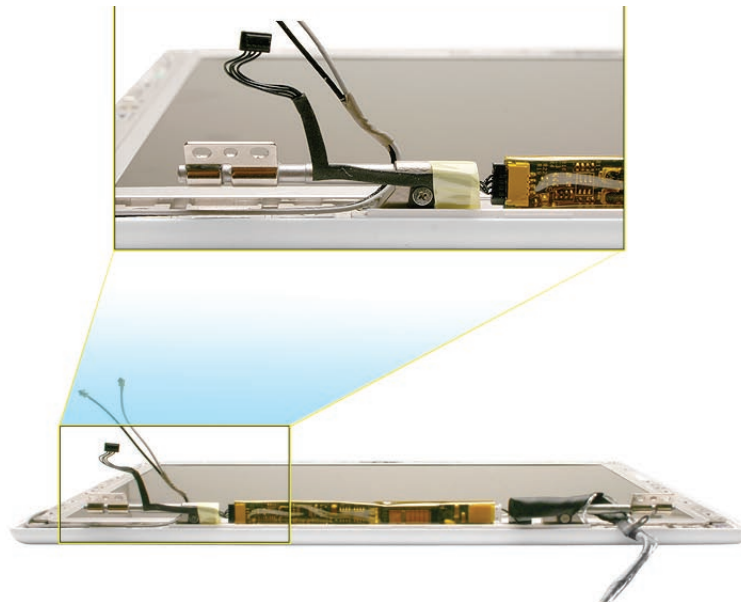

Procedure

1. With the display assembly resting on a clean, soft cloth, note the position of the inverter cable in relation to the left clutch barrel.
2. Remove the tape from the left clutch barrel.

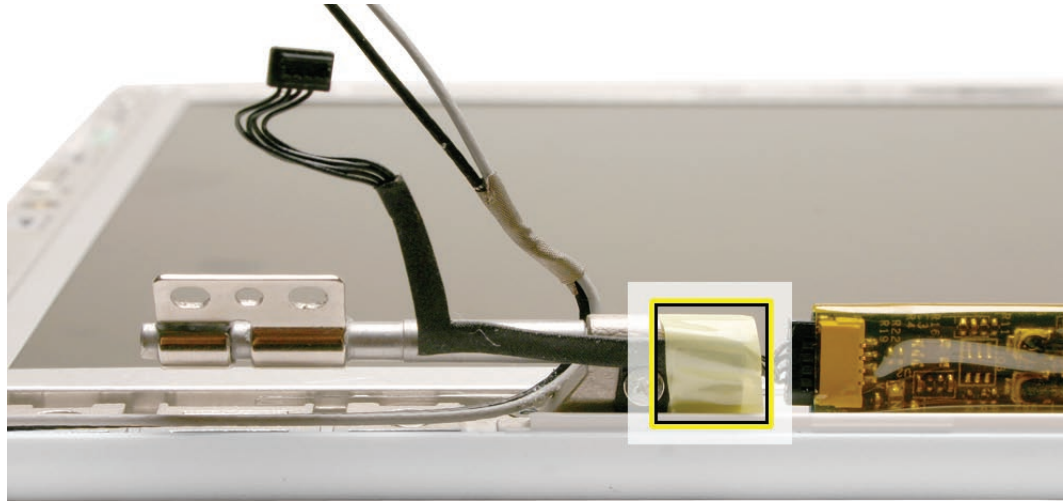

3. Remove the 3-mm long ground screw, and disconnect the inverter cable from the left end of the inverter board.

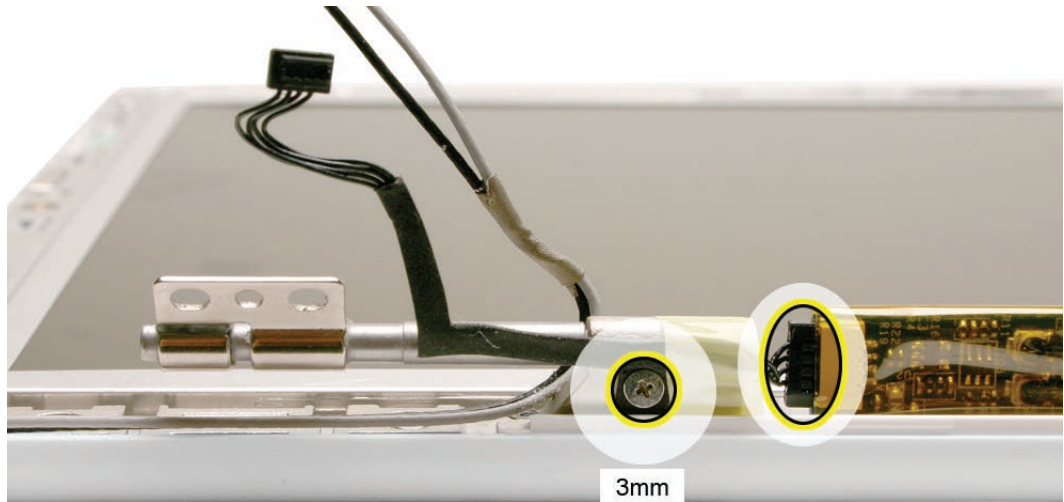

-
4. Remove the inverter cable from the display assembly.



5. Replace the inverter cable, and reassemble and test the computer
Replacement Note: Apply the tape where shown to secure the inverter cable to the left hinge.

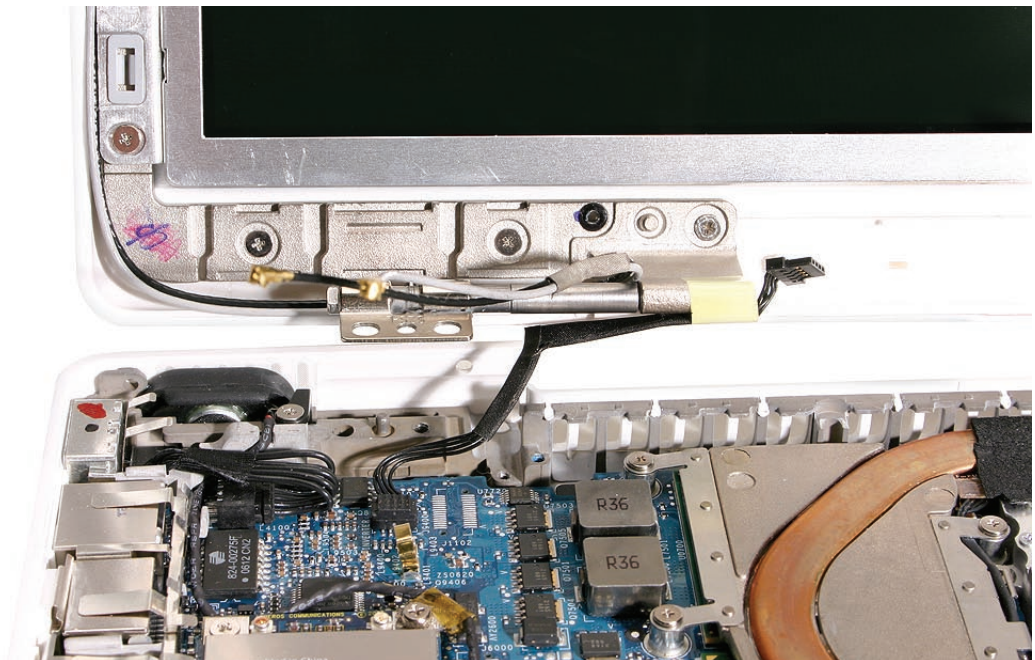



Display Hinges, Left and Right

Tools

- Soft cloth
- Magnetic Phillips #0 screwdriver
- Black stick (Apple part number 922-5065) or other nonconductive nylon or plastic flatblade tool

Preliminary Steps

Before you begin, remove

- Battery
- RAM door
- Top case with keyboard
- Optical drive
- Display module
- Display bezel
- Clutch cover
- Spacers at bezel scoops
- Bezel scoops
- Inverter board
- LCD panel assembly

Part Location

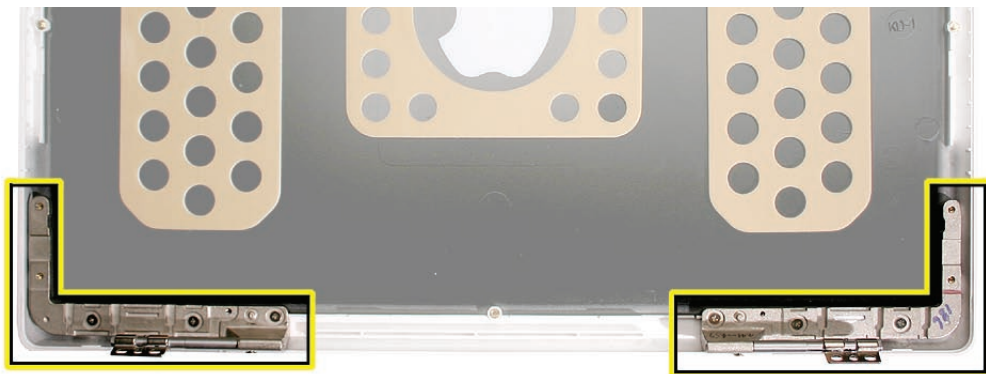

Procedure

1. With the display housing on a soft cloth, remove the three identical 4-mm long screws along the lower “arm” of each hinge.

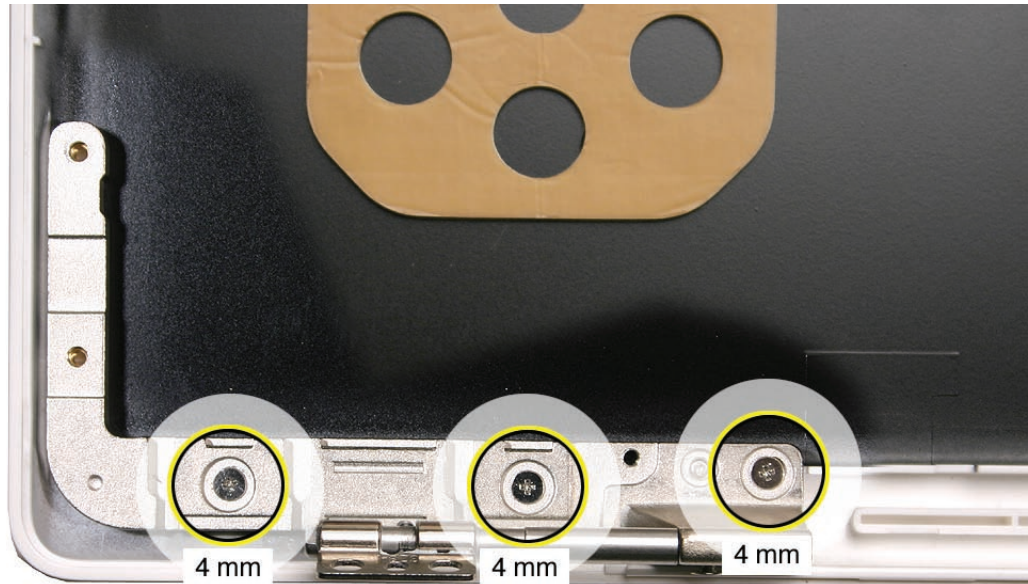

2. Use a black stick to carefully pry up each hinge from the double-sided tape holding it to the display rear housing.



Replacement Note: When installing new hinges, peel off the adhesive backing and align the hinges over the screw standoffs in the display rear housing.

3. Install the replacement display hinges, and reassemble and test the computer.

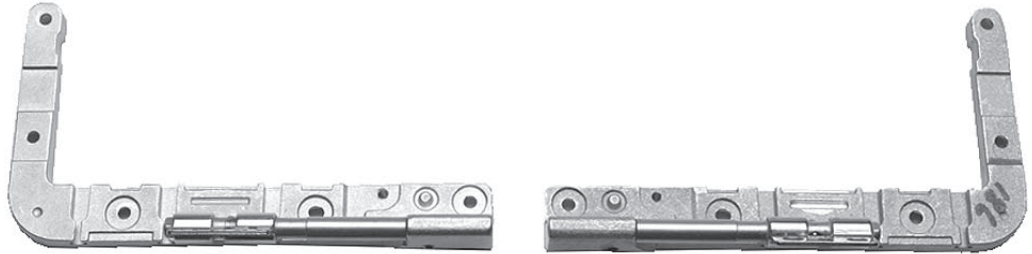



Bezel Brace, Left

The L-shaped bezel brace attaches to the left side of the LCD panel and includes integral tabs for the AirPort antenna cable routing.

Tools

With the preliminary steps completed, no tools are required for this procedure.

Preliminary Steps

Before you begin, remove

- Battery
- RAM door
- Top case with keyboard
- Optical drive
- Display module
- Display bezel
- Clutch cover
- Spacers at bezel scoops
- Bezel scoops
- Inverter board
- LCD panel assembly
- Antenna receptors and cables, top and left

Part Location



Procedure

1. With the wireless antenna receptors removed, the left bezel brace is loose from the LCD panel assembly.
2. Follow the replacement instructions in “Antenna Receptors and Cables” to attach the cables before installing the replacement left bezel brace. Then reassemble and test the computer.



Bezel Brace, Right

The L-shaped bezel brace attaches to the right side of the LCD panel and includes integral tabs for the microphone cable routing.

Tools

- Soft cloth
- ESD wrist strap and mat
- Magnetic Phillips #0 screwdriver
- Black stick (Apple probe tool, part number 922-5065) or other nonconductive nylon or plastic flatblade tool
- Access card (Apple part number 922-7172)

Preliminary Steps

Before you begin, remove

- Battery
- RAM door
- Top case with keyboard
- Optical drive
- Display module
- Display bezel
- Clutch cover
- Spacers at bezel scoops
- Bezel scoops
- Inverter board
- LCD panel assembly
- Antenna receptor and cable, right (Late 2006 model only)

Part Location

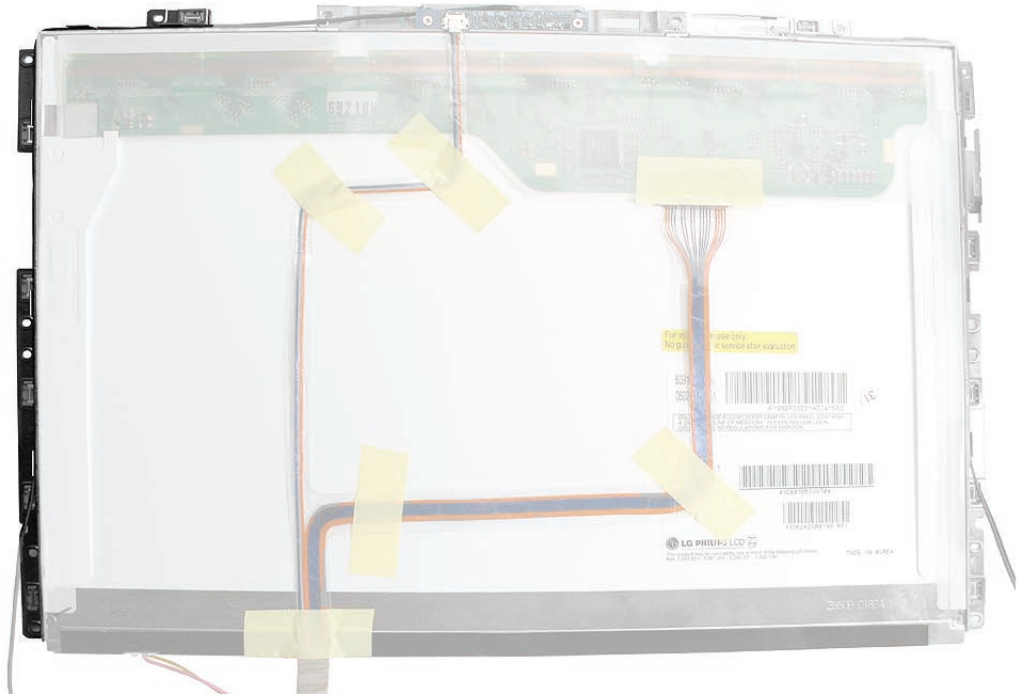

Procedure

Caution: Do not press on the LCD panel during this procedure.

1. Note how the microphone cable is routed through the tabs on the right bezel brace.

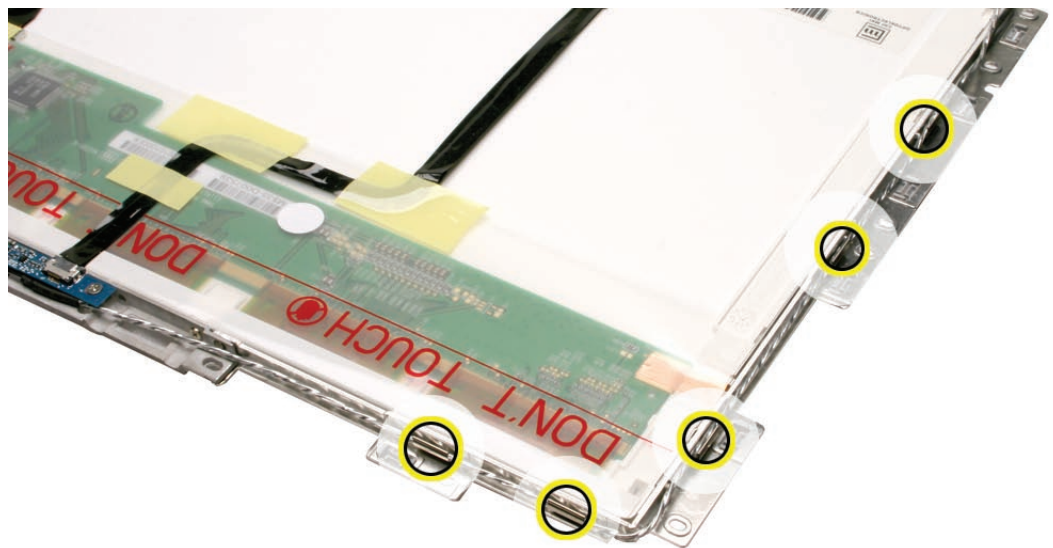

- Without straining the microphone cable, use a black stick to loosen it from the tabs.
- Remove the three identical 3-mm long screws (these can be identified by the small screw head) from the right side of the LCD panel.

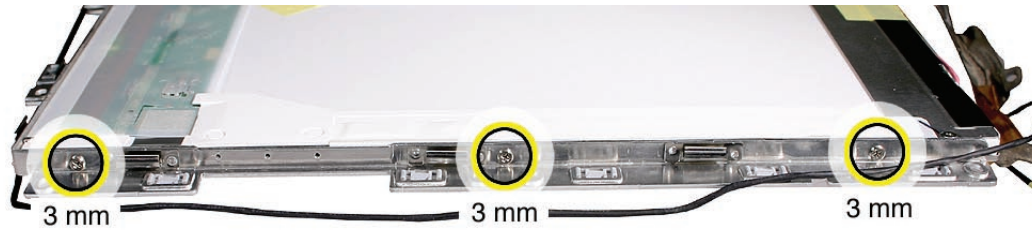

- Remove the 3-mm long camera bracket screw.

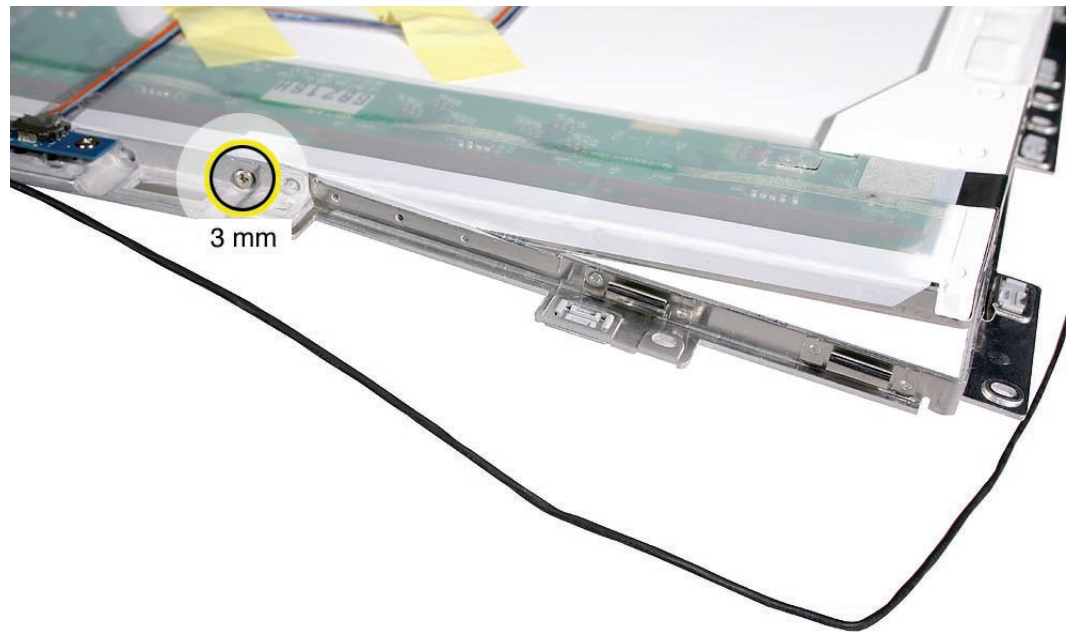

- Without straining the USB flex cable, tilt up the camera bracket and remove the right bezel brace from the LCD panel assembly.

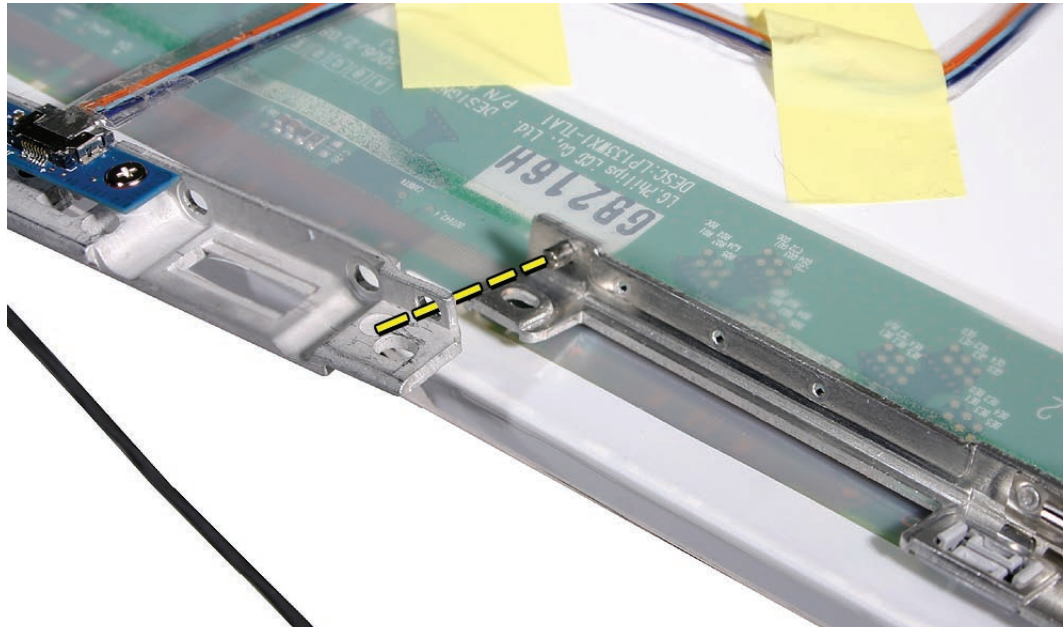

- Install the replacement right bezel brace, and reassemble and test the computer.





Sleep Magnet

Tools

- Soft cloth
- Black stick (Apple probe tool, part number 922-5065) or other nonconductive nylon or plastic flatblade tool
- Jeweler's flatblade screwdriver

Preliminary Steps

Before you begin, remove

- Battery
- RAM door
- Top case with keyboard
- Optical drive
- Display module
- Display bezel
- Clutch cover
- Spacers at bezel scoops
- Bezel scoops
- Inverter board
- LCD panel assembly

Part Location

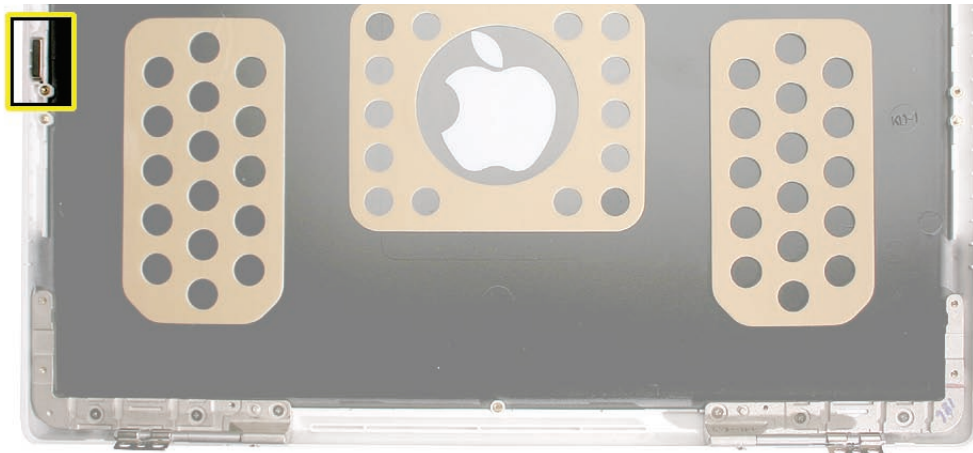

Procedure

1. With the display rear housing on a soft cloth, note the position of the sleep magnet recessed in the left side of the housing.
2. Using a black stick or a jeweler's flatblade screwdriver, insert the tip of the black stick or screwdriver in the tiny opening under the magnet, and pry up the sleep magnet from the left side of the display rear housing.



Replacement Note: Notice the beveled shape of the magnet. Position the magnet in the display rear housing so that the wider base of the magnet sits in the opening. Make sure the magnet is securely in place before reassembling the display module.

-
3. Install the replacement sleep magnet, and reassemble and test the computer.

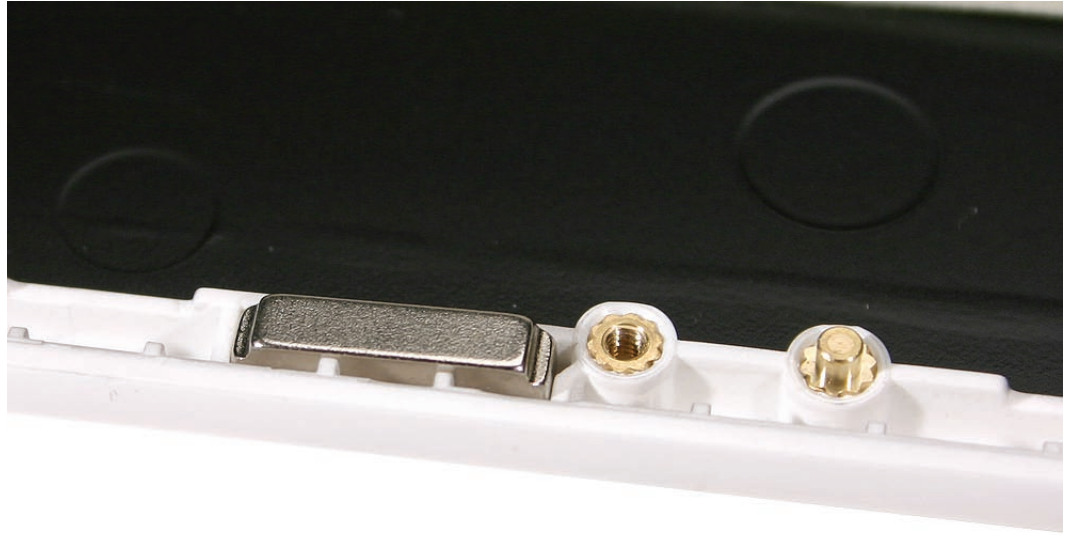



Display Magnet Pairs

Tools

- Soft cloth
- Black stick (Apple probe tool, part number 922-5065) or other nonconductive nylon or plastic flatblade tool
- Jeweler's flatblade screwdriver

Preliminary Steps

Before you begin, remove

- Battery
- RAM door
- Top case with keyboard
- Optical drive
- Display module
- Display bezel
- Clutch cover
- Spacers at bezel scoops
- Bezel scoops
- Inverter board
- LCD panel assembly

Part Location

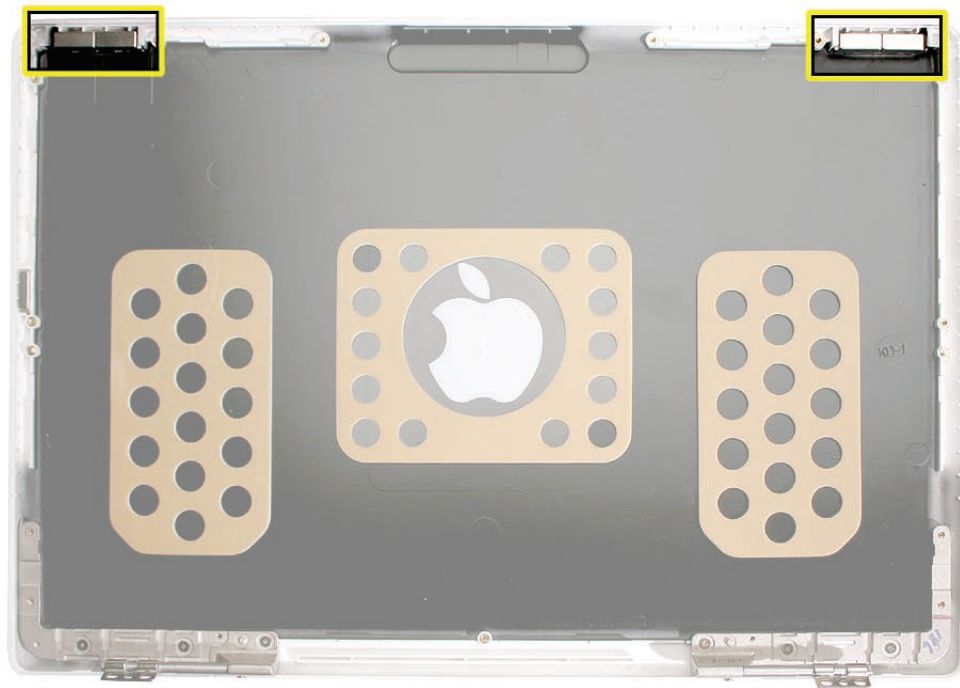

Procedure

1. With the display rear housing on a soft cloth, note the position of the magnet pairs recessed in the top corners of the display rear housing.
2. If the magnet pairs are tight in the slots, use a black stick or a jeweler's flatblade screwdriver to remove the magnet pairs from the display rear housing.

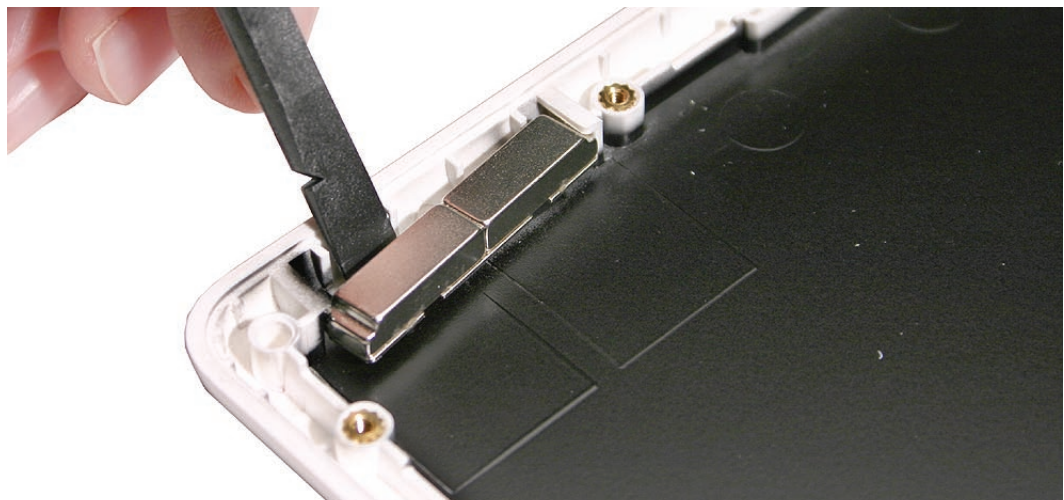

-
3. Install the replacement display magnet pairs, and reassemble and test the computer.

Replacement Note: Make sure a metal shunt is attached and correctly aligned to the base of each magnet pair. The magnet pairs are interchangeable between the left and right side of the display rear housing.



Slide the replacement magnet pairs into the top recessed areas of the display rear housing.

Replacement Note: In addition to the magnet pairs, check that the sleep magnet is also installed in the rear housing, left side.

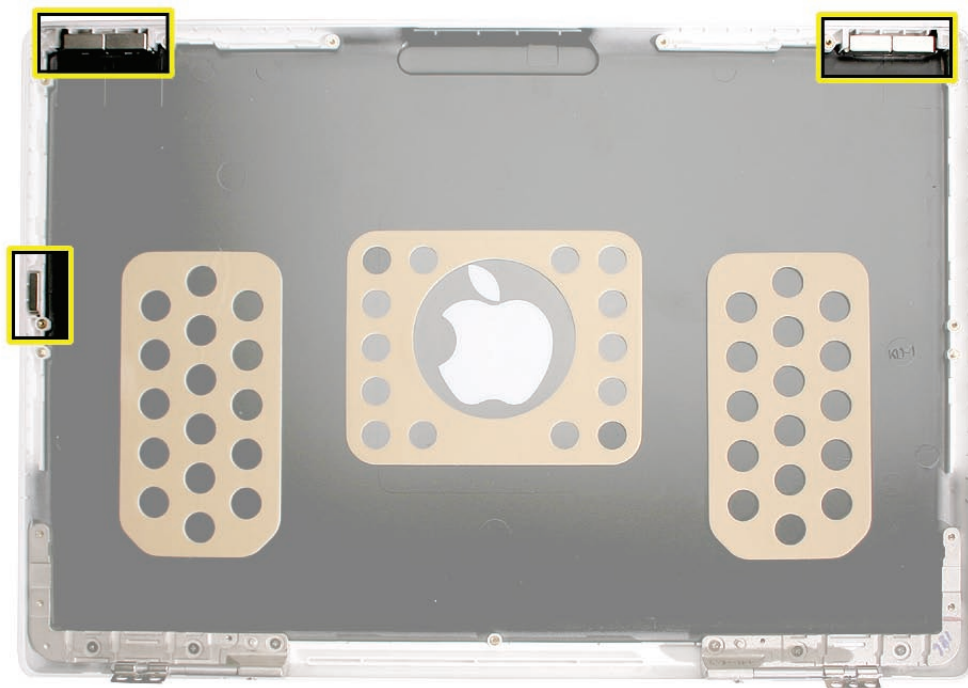

Replacement Note: When installing the LCD panel assembly, the magnets may be drawn to the metal frame and become loose. Make sure they are fitted back in the rear housing before tightening any screws on the LCD panel assembly.

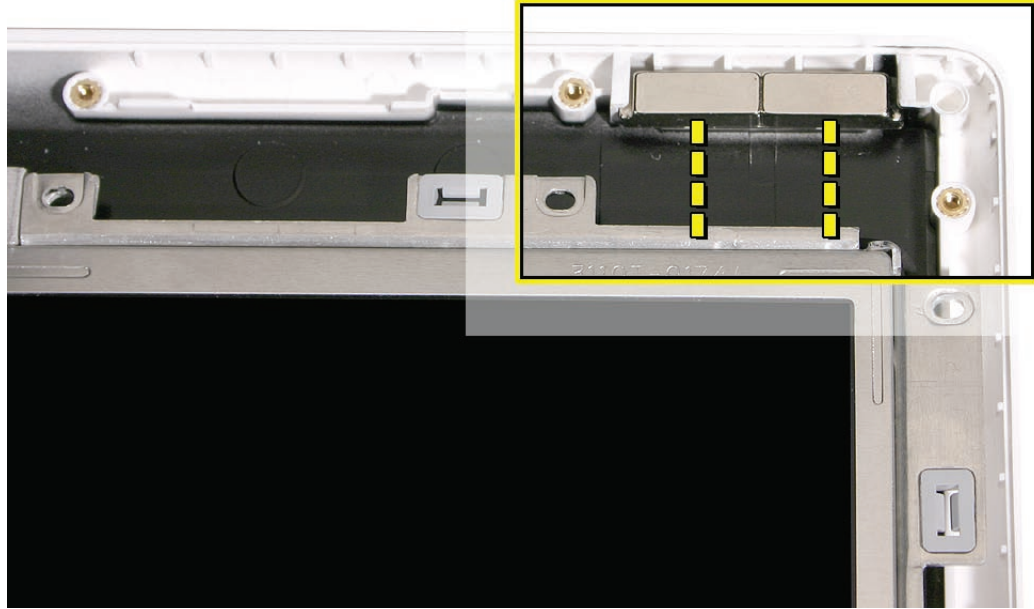



Display Rear Housing

Tools

- Soft cloth

Preliminary Steps

Before you begin, remove

- Battery
- RAM door
- Top case with keyboard
- Optical drive
- Display module
- Display bezel
- Clutch cover
- Spacers at bezel scoops
- Bezel scoops
- Inverter board
- LCD panel assembly
- Display magnet pairs, left and right
- Display hinges, left and right
- Sleep magnet
- Display magnet pairs, left and right

Part Location

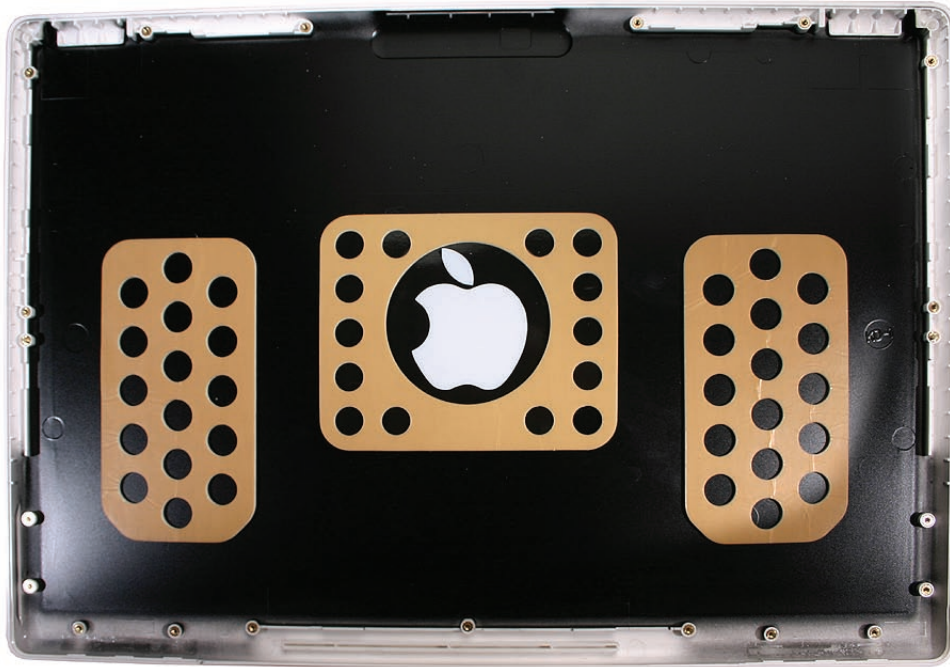

Procedure

1. When all of the parts listed in the preliminary steps are removed, the remaining part is the display rear housing.



Replacement Note: When reassembling the LCD panel assembly in the display rear housing, make sure the magnet pairs and sleep magnet are secured in place.

2. Reassemble and test the computer.

Replacement Note: The display rear housing comes with the pre-installed Apple logo, sponge pads, and corner brackets in the upper left and right corners.

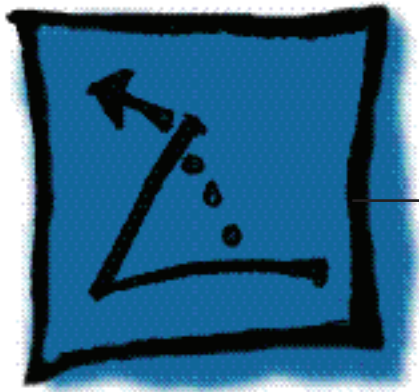

Additional Procedures

MacBook (13-inch)

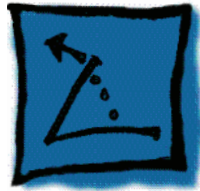

General Information

Notes on Replacing Keycaps

When a key on the keyboard need replacement, you can avoid the cost of replacing a whole top case by just replacing a keycap. The method for replacing keys depends on the type of keyboard and the manufacturer. This chapter provides guidance on identifying and replacing keys on the Darfon and Mitsumi top cases.

If your service site can store a few discarded top cases, the keys may be salvaged for use when replacing keys.



Replacing Darfon Keycaps

Tools

- ESD wrist strap and mat
- Black stick (Apple part number 922-5065) or other nonconductive nylon or plastic flatblade tool
- Fine-point tweezers
- Needlenose pliers

Preliminary Steps

Before you begin, remove the battery.

Part Location



Procedure

The keycaps are secured to the top case keyboard with a scissor mechanism. This mechanism operates the same for all keys although its design differs depending on the shape of the key. For instance, square keys (i.e., letters A–Z, numbers, punctuation) employ an identical scissor mechanism, whereas larger, rectangular keys (i.e., Shift, Delete, Return, Space bar) use slightly different scissor mechanisms and employ one or two metal stabilizer bars.

Removing and Replacing a Square Key

1. If a key needs to be removed (for example, if a key is sticking when pressed), always pry it up from the left side—either the upper or lower left corner.



2. Because adhesive is used under the top case, closely inspect the case for any adhesive that may have built up under the keycap. Lift away any built-up adhesive using a black stick or fine-point tweezers.

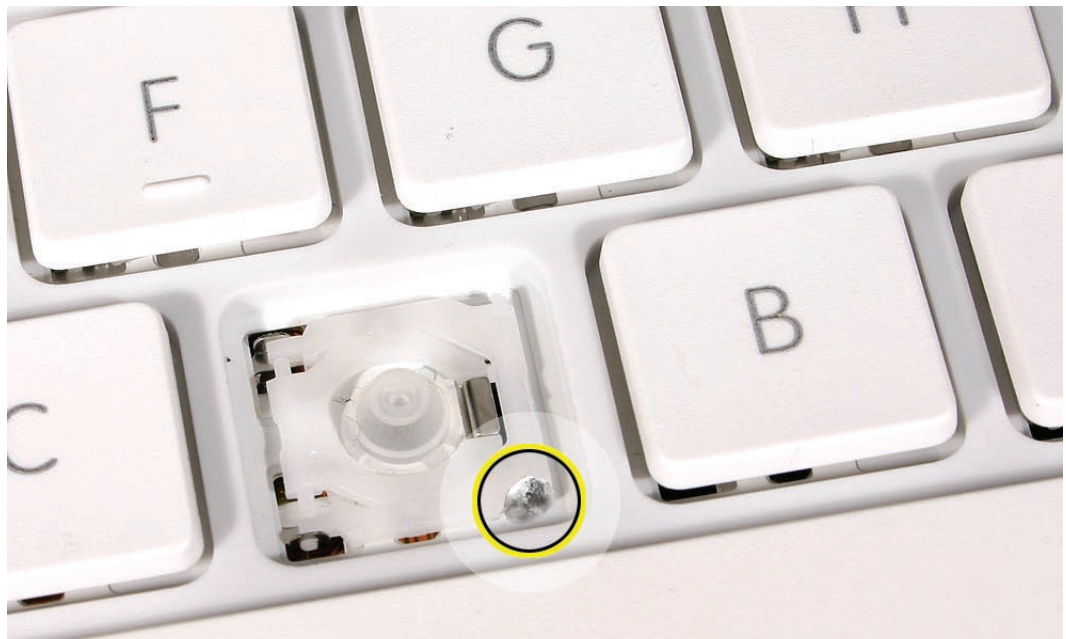

3. Test the operation of the scissor mechanism by using a black stick to carefully raise and lower the mechanism.



- If it is installed correctly, the scissor should move smoothly.
- If it is loose, remove it and compare the two parts of the scissor mechanism to the image below.
 - The inner piece should pivot smoothly within the outer piece.
 - When closed, its profile should be fully flat.
 - The slider bar and all four pins should be intact.

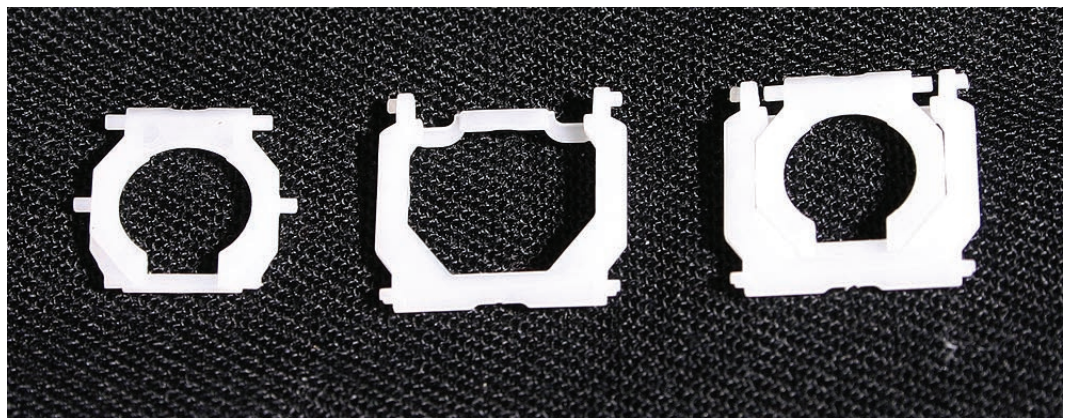

4. Check the underside of the keycap for two clips on one side and two hooks on the other side.

- If any of the hooks or clips are bent, broken, or missing, replace the keycap.
- If the hooks and clips are intact, re-use the keycap.

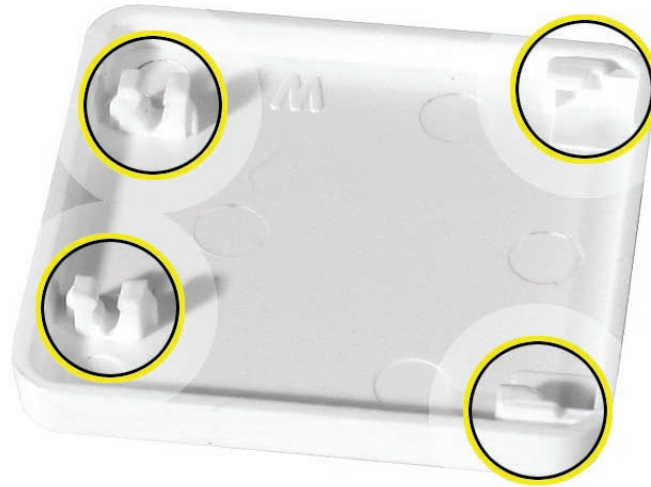

5. Check the rubber dome and raised metal areas inside the keycap opening on the top case.

- When the rubber dome is pressed and released, it should spring back upright. If the rubber dome is off center or damaged, replace the top case.
- If the metal hook that holds the slider bar of the scissor mechanism is bent, try to bend it back to a uniform 90-degree angle. If it is bent or broken beyond repair, replace the top case.
- If the two metal ears are bent, use needlenose pliers to straighten them. If either or both are broken beyond repair, replace the top case.

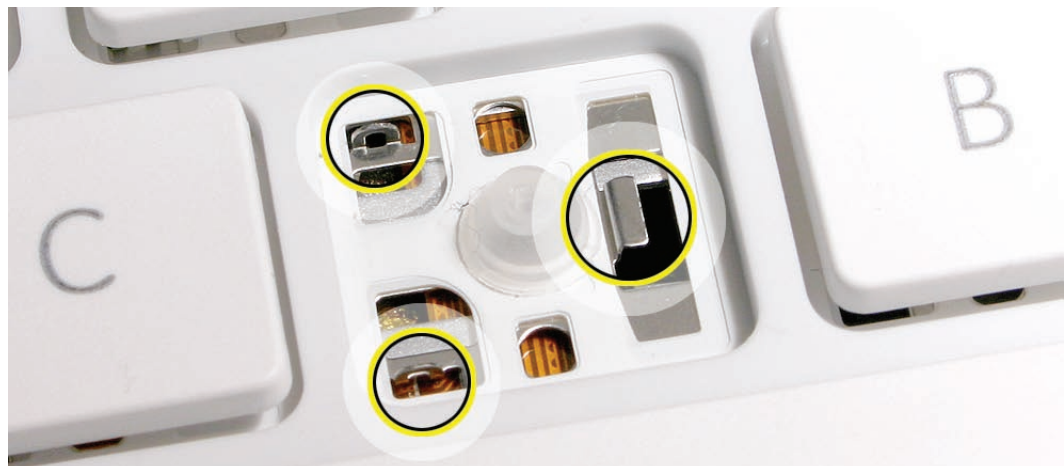

6. With the scissor mechanism open, install the slider bar under the metal hook of the top case.



7. Allow the scissor mechanism to fold flat and hold the slider bar in place while using a black stick to insert the scissor pins—one at a time—into the top case ears.

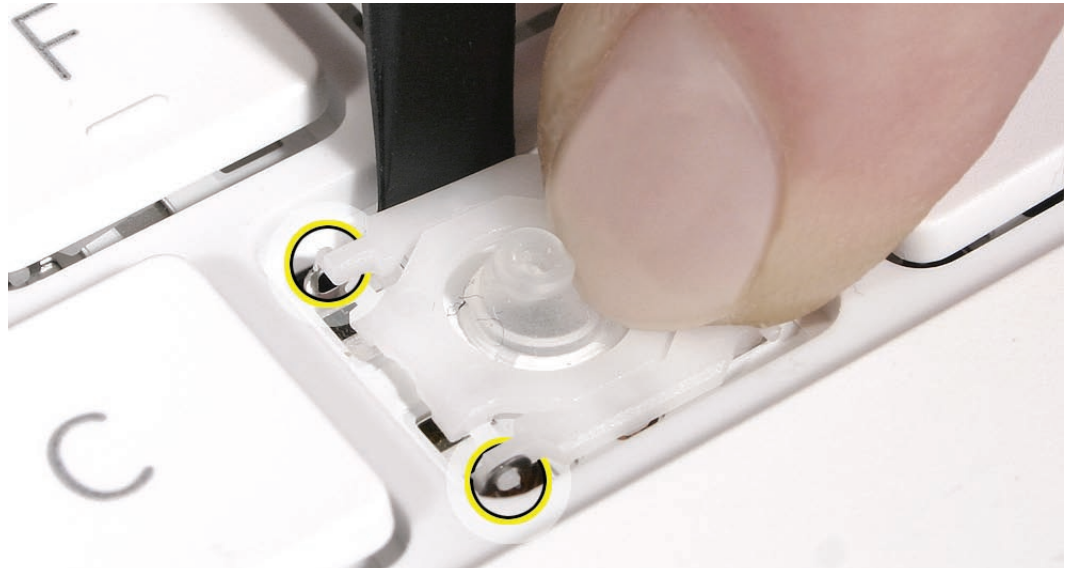

8. With the scissor pins inserted, use a black stick to raise and lower the scissor mechanism to make sure it moves freely.



9. Moving from left to right, slide the right end of the keycap into the keycap well so that the hooks inside the right side of the keycap latch onto the pins on the right side of the scissor mechanism.

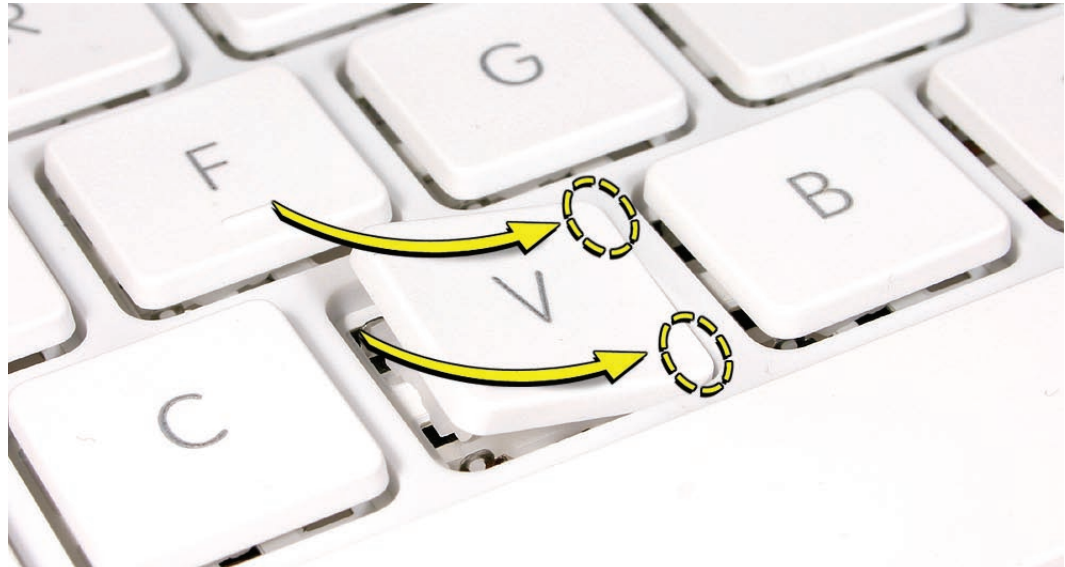

10. Press down on the left side of the key until the keycap snaps into place.

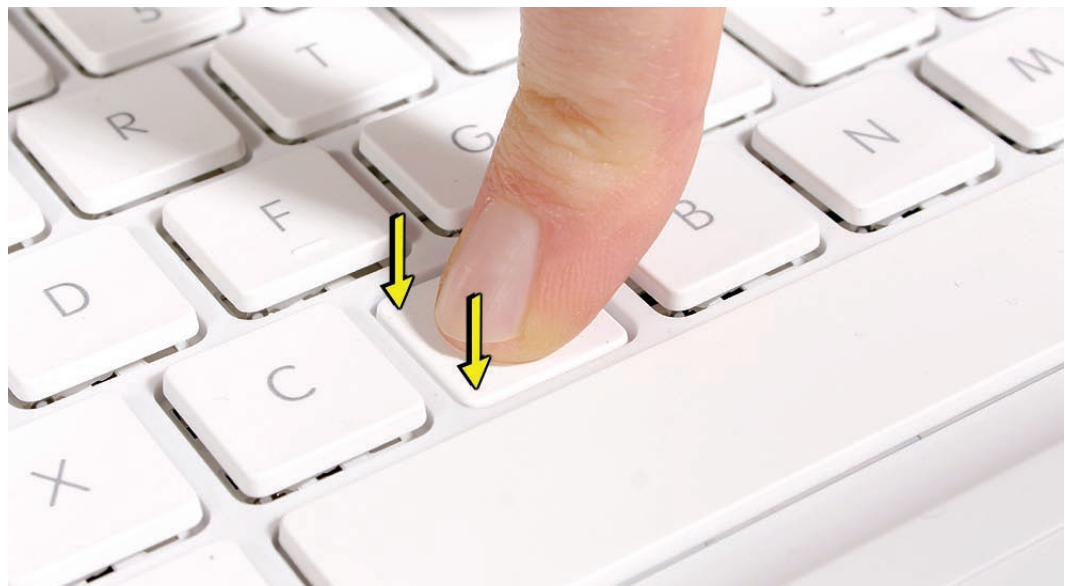

11. Check the key from all angles to make sure it is uniformly flat. Press and release the key repeatedly to verify that it springs back each time.

Reassembling the Scissor Mechanism

If the two pieces of a scissor mechanism come apart,

- Check that the pieces are not damaged. The image below shows the separate scissor pieces and the fully assembled scissor mechanism.
- Flex the outer piece to install the pins of the inner piece in the slots. The intact scissor mechanism should swivel smoothly and fold flat.

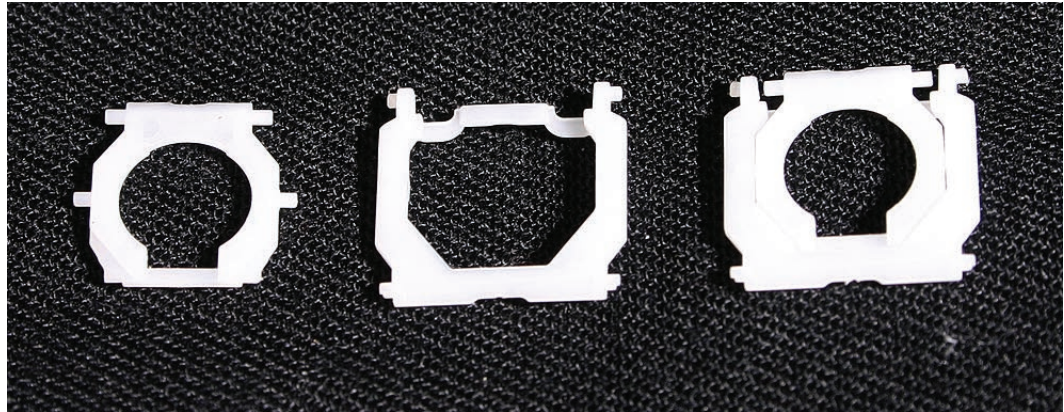

Removing and Replacing the Space Bar

1. If a rectangular-shaped key needs to be removed (for example, if a key is sticking when pressed), always pry it up from the left side—either the upper or lower left corner.



2. Because adhesive is used under the top case, closely inspect the case for any adhesive that may have built up under the keycap. Lift away any built-up adhesive using fine-point tweezers.

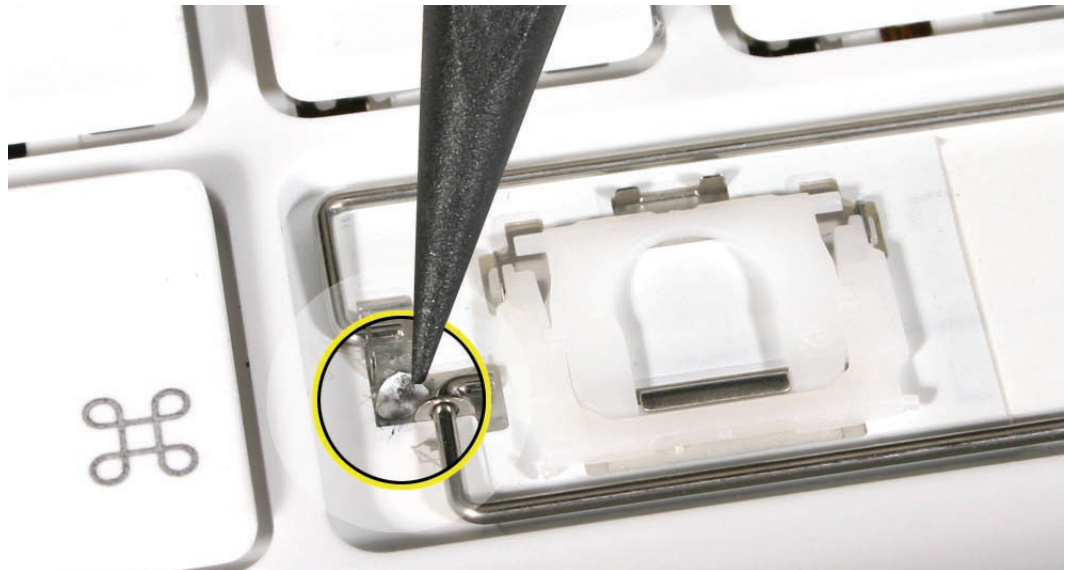

3. Test the operation of the scissor mechanism by using a black stick to carefully raise and lower the mechanism.



- If it is installed correctly, the scissor should move smoothly.
- If it is loose, remove it and compare the two parts of the scissor mechanism to the image below.
- The inner piece should pivot smoothly within the outer piece.

-
- When closed, its profile should be fully flat.
 - The slider bar and all four pins should be intact.



4. Inspect the rows of clips on the underside of the keycap.
 - If any of the clips are bent, broken, or missing, replace the keycap.
 - If the clips are intact, re-use the keycap.

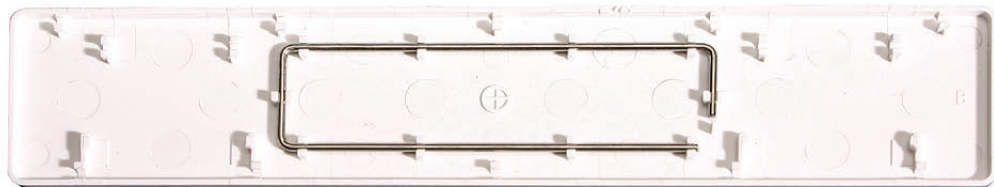

5. Check the rubber dome and raised metal areas inside the keycap opening on the top case.

- When the rubber dome is pressed and released, it should spring back upright. If the rubber dome is off center or damaged, replace the top case.

- If the metal hook that holds the slider bar of the scissor mechanism is bent, try to bend it back to a uniform 90-degree angle. If it is bent or broken beyond repair, replace the top case.

- If the two metal ears are bent, use needlenose pliers to straighten them. If either or both are broken beyond repair, replace the top case.

- If a metal stabilizer bar is bent, try to straighten it.



6. With the scissor mechanism open, install the slider bar under the metal hook of the top case.

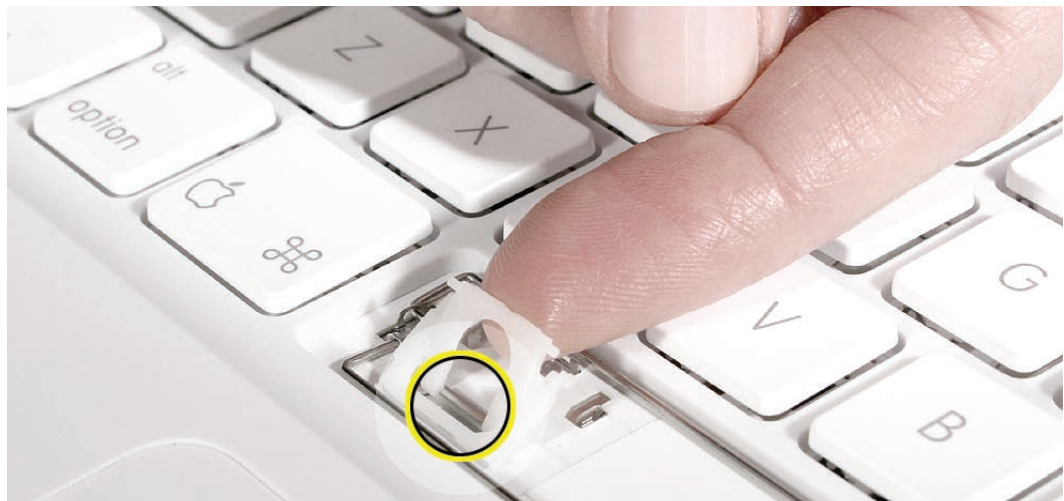

7. Allow the scissor mechanism to fold flat and hold the slider bar in place while using a black stick to insert the scissor pins—one at a time—into the top case ears.

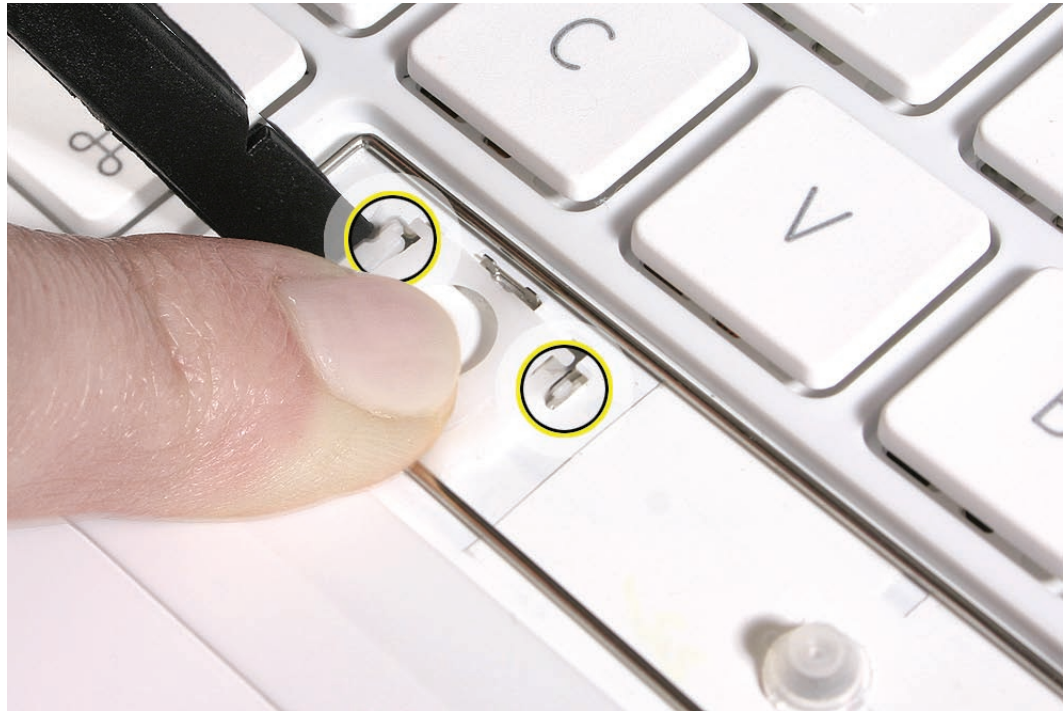

8. With the scissor pins inserted, use a black stick to raise and lower the scissor mechanism to make sure it moves freely.



9. Check the keycap well area on the top case. If the bottom stabilizer bar is pushed up, move it down as far as it will go.

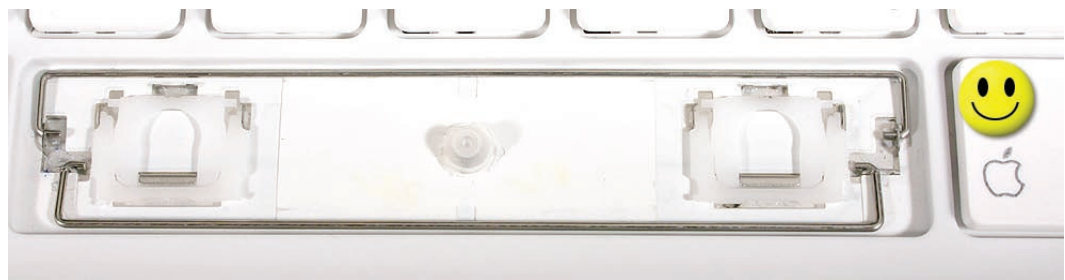

10. Determine which is the top of the Space bar keycap by checking the clips on the inner plane. The top of the keycap has the row of clips that extend closest to the sides of the keycap. These top clips most closely match the longest stabilizer bar at the top of the keycap well.

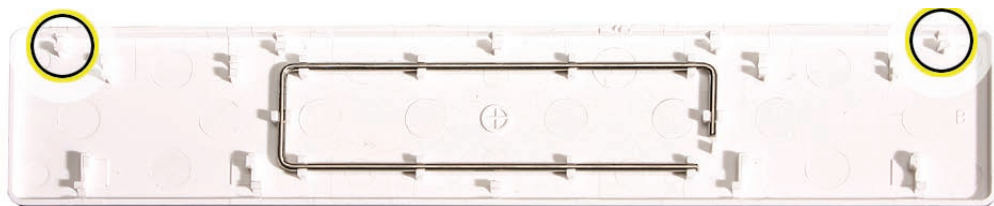

11. Align the bottom row of clips inside the bottom edge of the keycap with the bottom stabilizer bar.

12. Press and slide your finger along the **bottom** of the Space bar over the bottom stabilizer bar until you hear the clips click into place. (The keycap is tilted up at this stage.)



13. Press along the top of the Space bar to secure it to the top stabilizer bar. (Listen for the keycap clicking into place.)

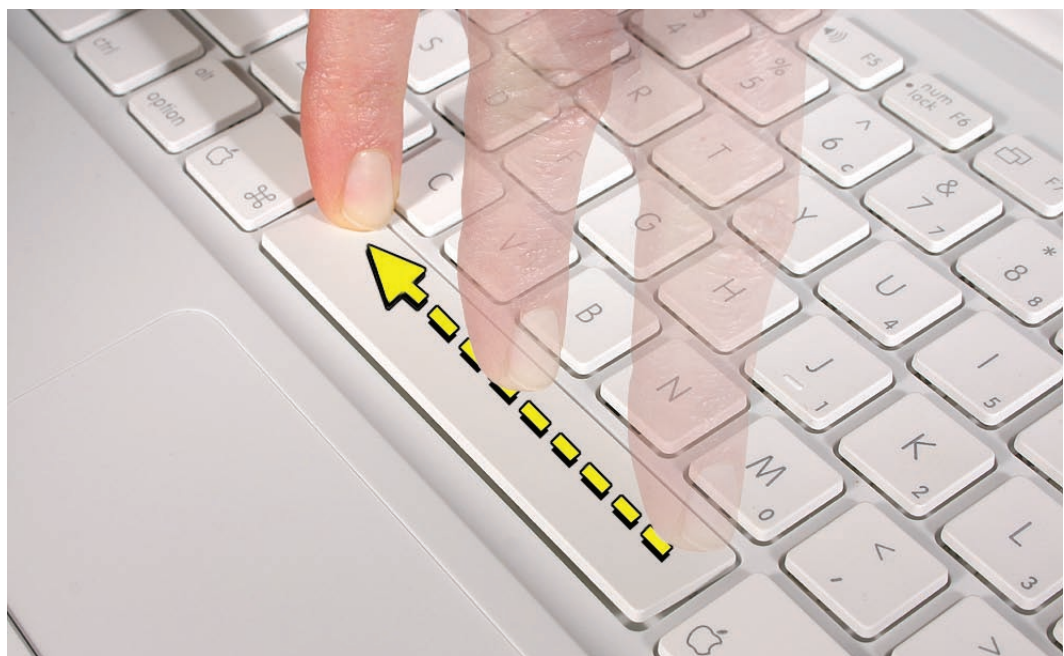

14. Press the length of the Space bar to ensure all clips are secure.

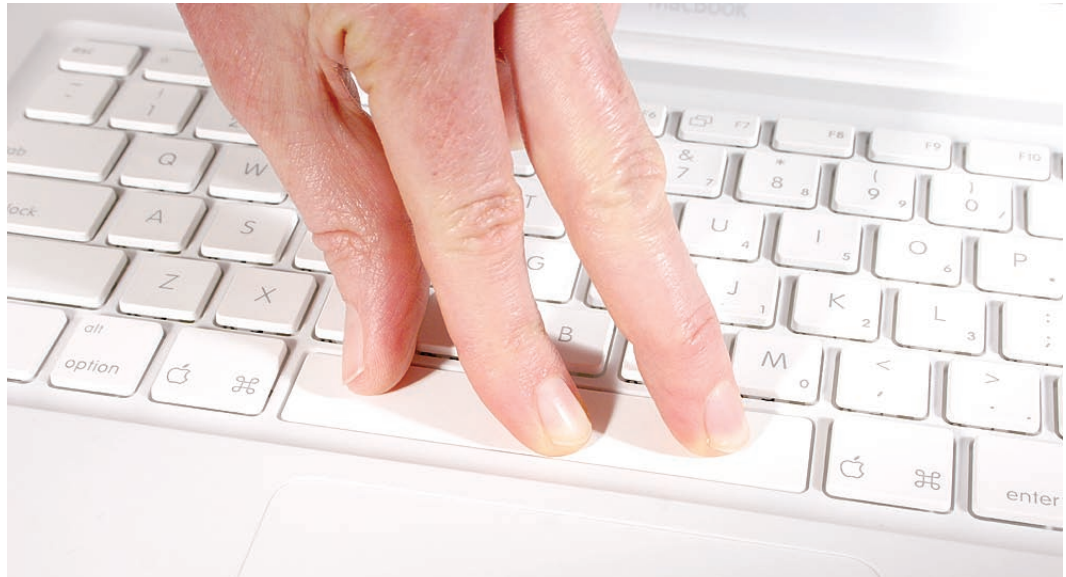

15. Check the key from all angles to make sure it is uniformly flat. Press and release one corner of the key. If the key is installed correctly, the opposite corner should respond at the same level (not tilted higher or lower).



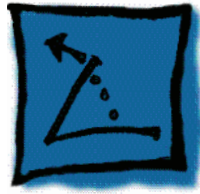

Replacing Mitsumi Keycaps

Tools

- ESD wrist strap and mat
- Black stick (Apple part number 922-5065) or other nonconductive nylon or plastic flatblade tool
- Fine-point tweezers
- Needlenose pliers

Preliminary Steps

Before you begin, remove the battery.

Part Location

The Mitsumi keyboard comes in three versions: ANSI, ISO, and JIS. Refer to the following keyboard layouts to help identify them.

ANSI Keyboard Layout:



ISO Keyboard Layout:



JIS Keyboard Layout:



Procedure

Like the Darfon keyboard, the Mitsumi keyboard is integrated in the top case and cannot be removed from the top case. The Mitsumi keyboard comes in three versions: ANSI, ISO, and JIS. The square keycaps for all three versions use the same dual-hinge mechanism inside the keycap well with one stabilizer bar inside the keycap.

For the Space bar replacement, the ANSI and ISO Space bar keycaps look the same: two single-hinge mechanisms and two stabilizer bars in the keycap well. The JIS Space bar keycap, by contrast, has two dual-hinge mechanisms and two stabilizer bars.

Once you are experienced replacing square keycaps and the Space bar, you can easily replace other size keys because of their shared traits. For example, the ANSI Return keycap has a dual-

hinge mechanism and one stabilizer bar; whereas the ISO and JIS Return keycap has no hinge mechanism and three stabilizer bars.

Important Tips:

Before installing a new keycap, make sure

- The clips on the underside of the keycap are not broken or bent.
- The hinge mechanism operates smoothly.
- The stabilizer bar is fully snapped into place
- The hinge mechanism is closed and slid farthest from the rubber dome before lowering the keycap over the keyboard well.

Removing and Replacing a Square Key

1. If a key needs to be removed (for example, if a key is sticking when pressed), pry it up from the top.

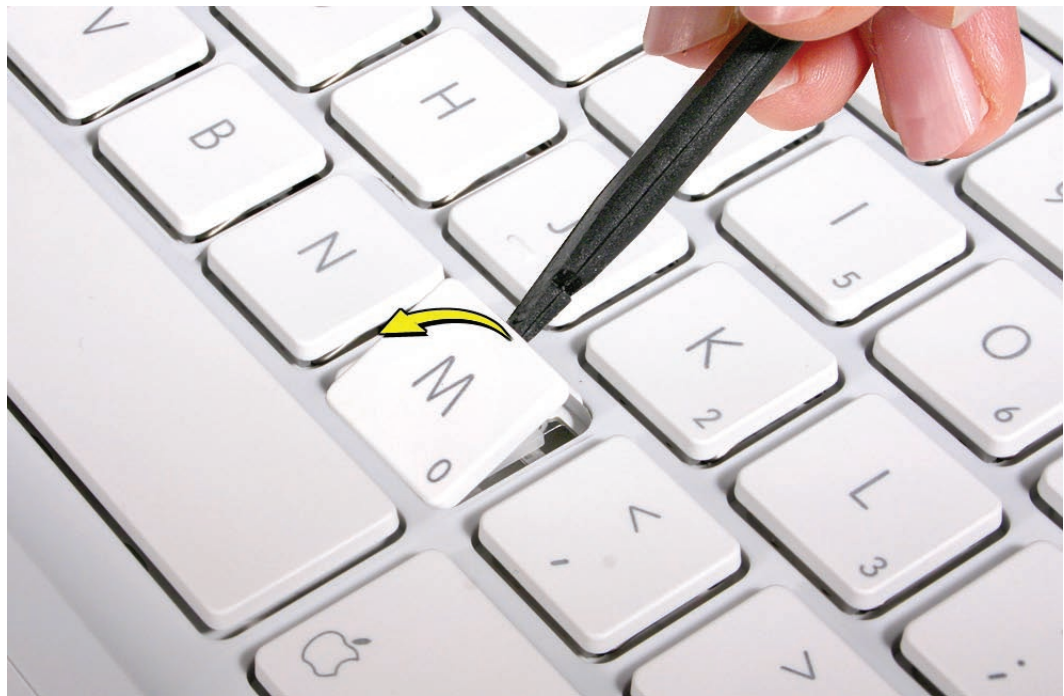

2. Because adhesive is used under the top case, closely inspect the case for any adhesive that may have built up under the keycap. Lift away any built-up adhesive using fine-point tweezers.

3. Note the stabilizer bar and clips on the underside of the keycap, and check that the dual-hinge mechanism lays flat.



4. Test the operation of the dual-hinge mechanism by using a black stick to carefully raise and lower the mechanism.

- If it is installed correctly, the hinged pieces should move smoothly.
- If it is damaged or loose, refer to the section “Reassembling the Hinge Mechanism.”



-
5. Check that the stabilizer bar can pivot easily within the hooked ends of the keycap.
 - If any of the hooks or clips are bent, broken, or missing, replace the keycap.
 - If the hooks and clips are intact, re-use the keycap.
 6. Check the rubber dome inside the keycap opening on the top case.
 - When the rubber dome is pressed and released, it should spring back upright.
 - If the rubber dome is off center or damaged, replace the top case.



7. With the stabilizer bar open, press the two ends of the slider bar into the slots in the keycap well so they snap into place.

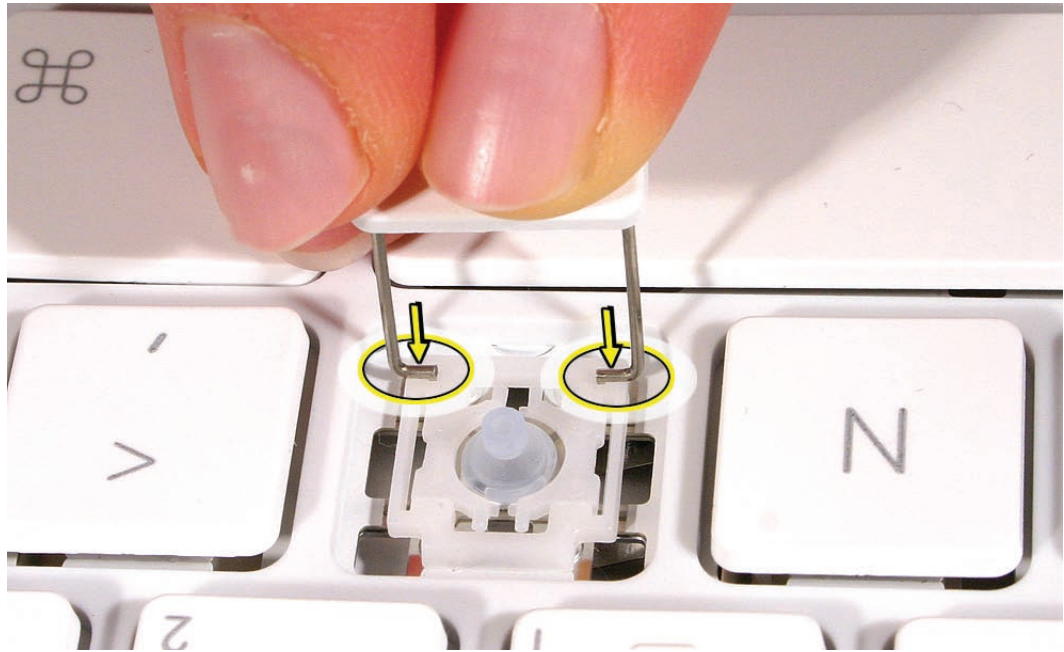

8. Allow the dual-hinge mechanism to fold flat, and use a black stick to make sure the hinged pieces are pushed farthest away from the rubber dome (this is a tiny movement).

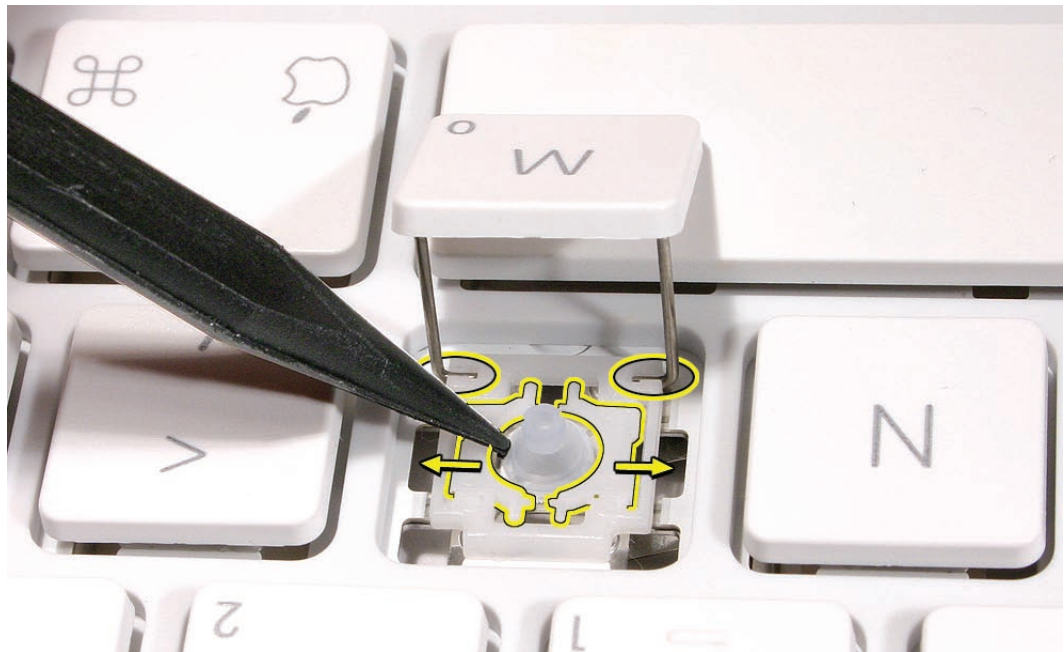

9. Carefully lower the keycap onto the top case, and press down on the center of the key until the keycap snaps into place.

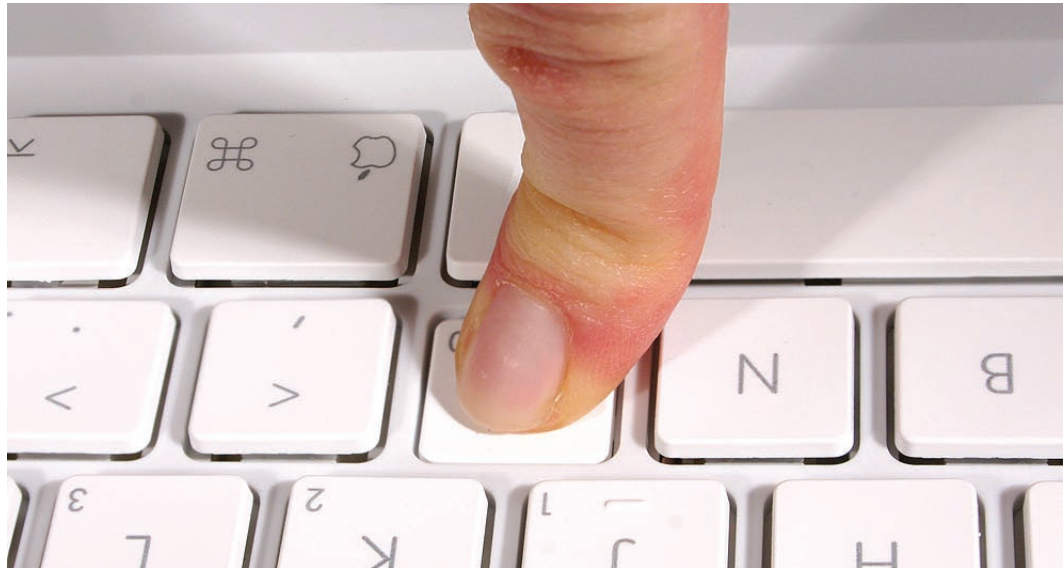

10. Check the key from all angles to make sure it is uniformly flat. Press and release the key repeatedly to verify that it springs back each time.

Reassembling the Hinge Mechanism

This procedure shows images from a JIS keyboard; however, the steps for replacing the hinge mechanism are the same for any versions of the Mitsumi keycaps.

1.If a hinge piece becomes loose from the top case, check that the hinge piece is not damaged.

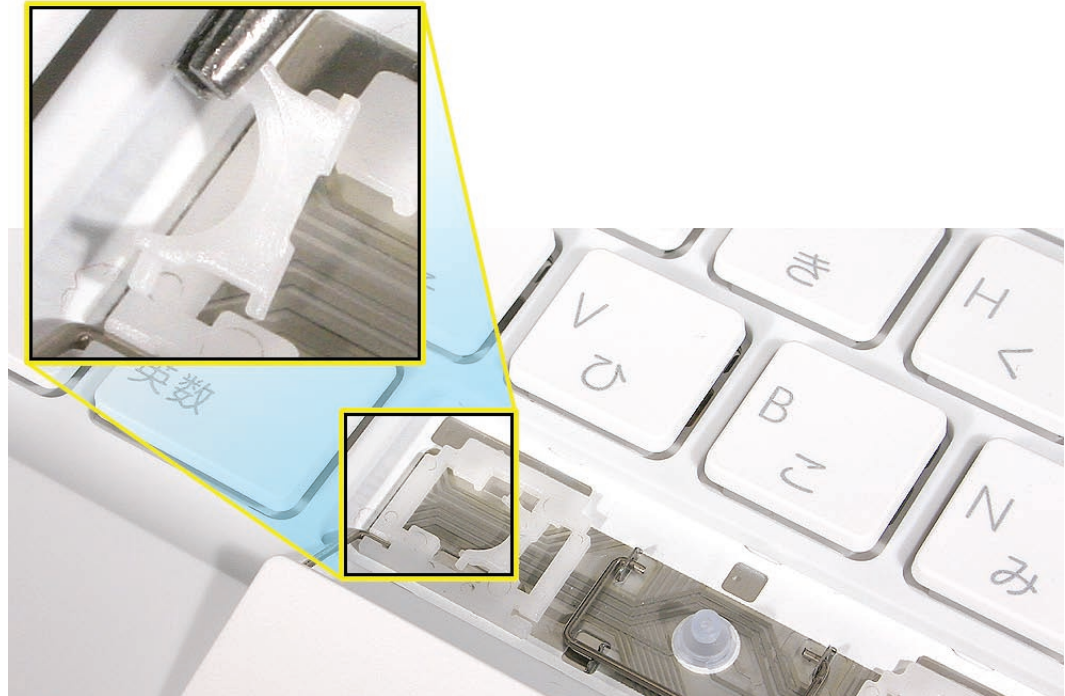

2. Check both sides of the hinge piece. Note that the top plane of the hinge piece has two barely visible recessed circles, and the end pins fit into the hooked slots on the anchored plane inside the keycap well.

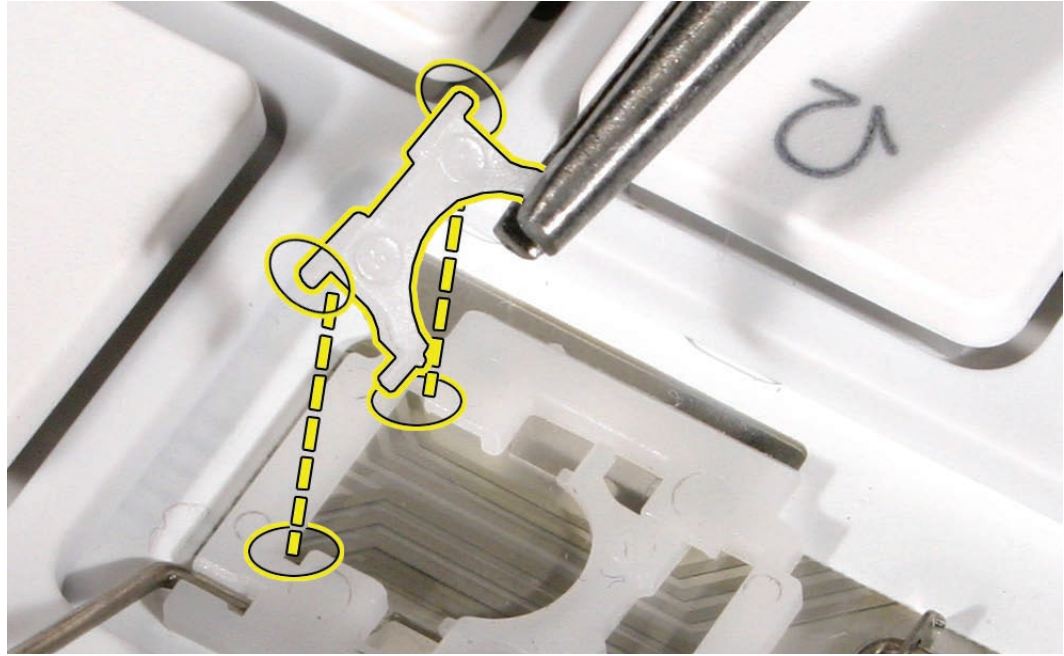

3. With the hinge piece held vertically, position it into the hooked area (1), and slide it forward (2) so it becomes anchored in place and can fold down fully flat.

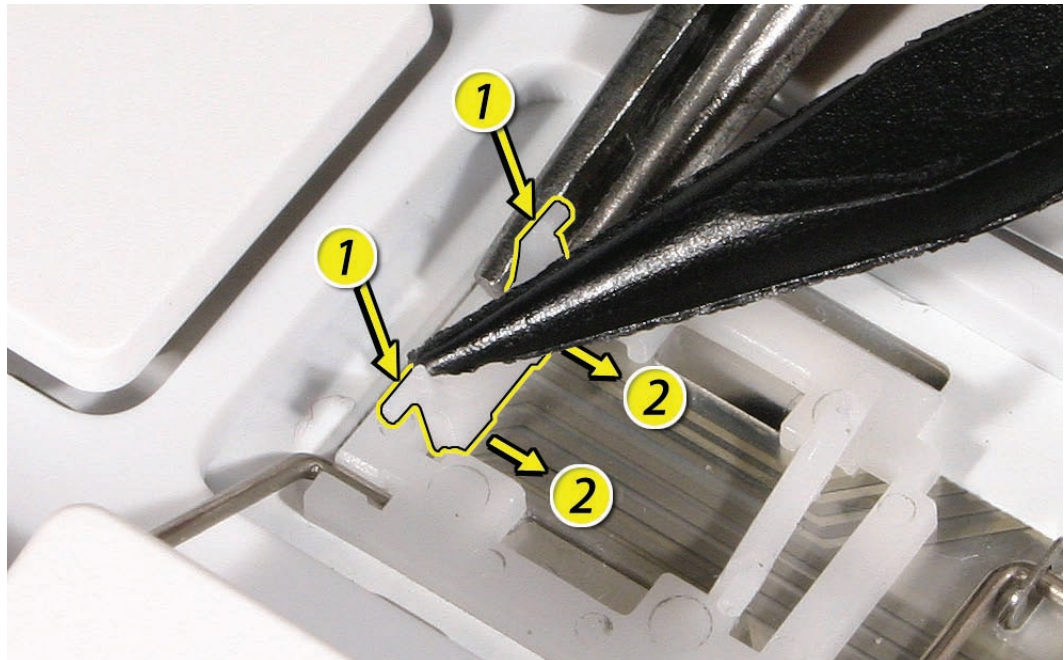

Replacement Note: If the hinge piece is upside-down, it will not lay fully flat.

Removing and Replacing an ANSI or ISO Space Bar

1. If a Space bar needs to be removed (for example, if it is sticking when pressed), pry it up from the top edge first.

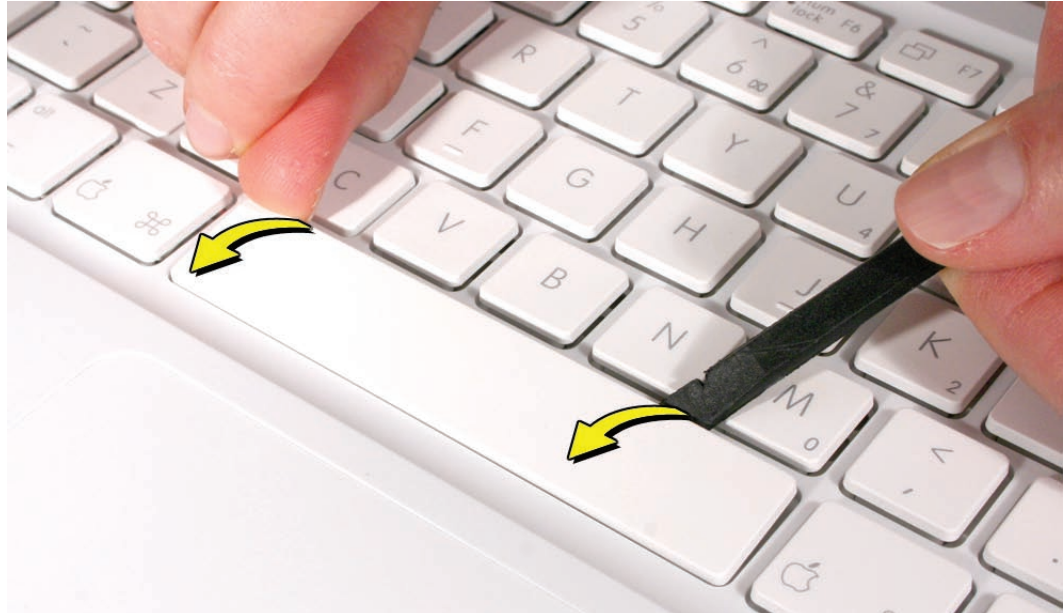

2. With the top edge loosened, pry up the Space bar from the lower edge. Use a black stick, if necessary, to tilt up the key.



3. Because adhesive is used under the top case, closely inspect the case for any adhesive that may have built up under the keycap. Lift away any built-up adhesive using fine-point tweezers.

4. Check that the longest stabilizer bar can pivot easily within the four hooks of the keycap.

- If any of the hooks or clips are bent, broken, or missing, replace the keycap.
- If the hooks and clips are intact, re-use the keycap.

5. Check the rubber dome inside the keycap well on the top case.

- When the rubber dome is pressed and released, it should spring back upright.
- If the rubber dome is off center or damaged, replace the top case.

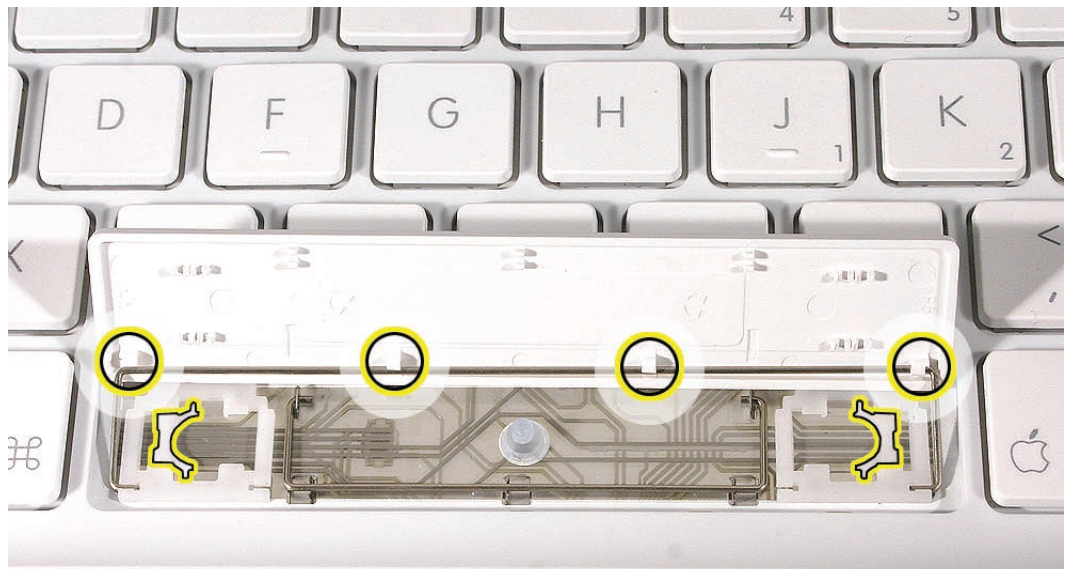

6. With the stabilizer bar open, make sure the two ends of the slider bar are secured into the slots in the keycap well.

7. Make sure the single-hinge mechanism on both ends of the keyboard well is fully flat and pressed as far as it will go away from the rubber dome. Then lower the keycap so that the three clips align with the smaller stabilizer bar.

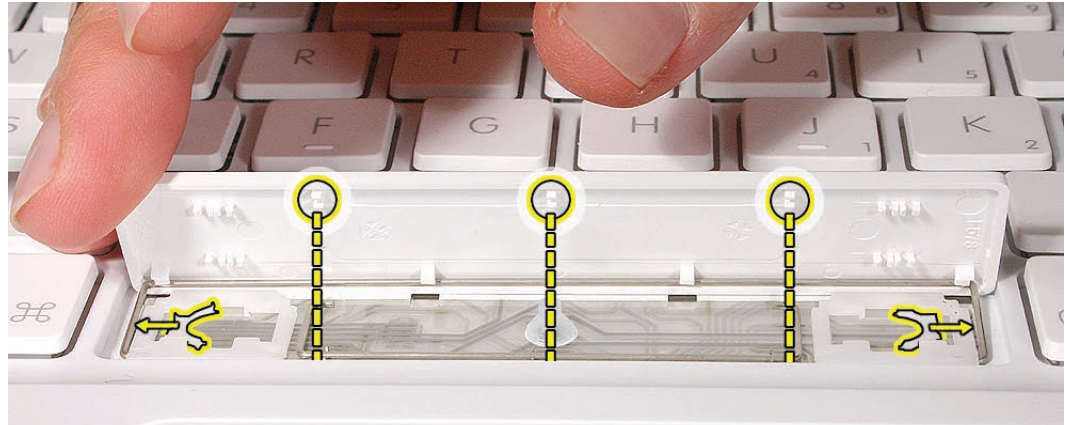

8. Lower the key down.

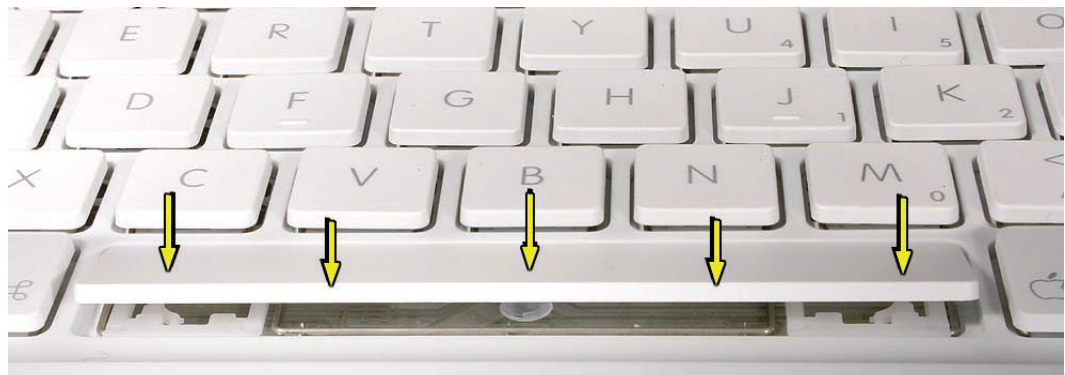

9. Press the major contact points, and then press over the entire key to hear it snap into place.

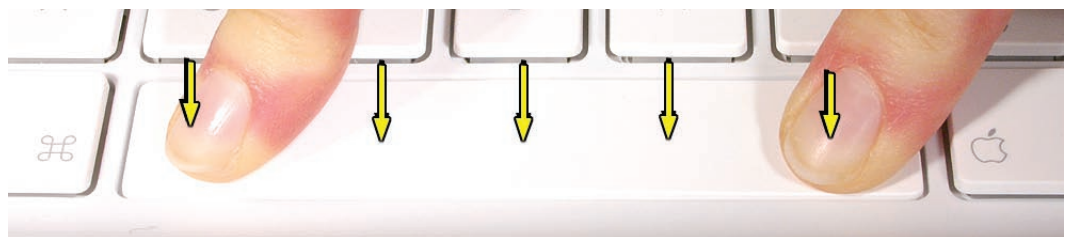

10. Check the Space bar key from all angles to make sure it is uniformly flat. Press and release one corner of the key. If it is installed correctly, the opposite corner should move at the same level.

Removing and Replacing a JIS Space Bar

1. If a Space bar needs to be removed (for example, if it is sticking when pressed), pry it up from the top edge first.



2. With the top edge loosened, pry up the Space bar from the lower edge. Use a black stick, if necessary, to tilt up the key.

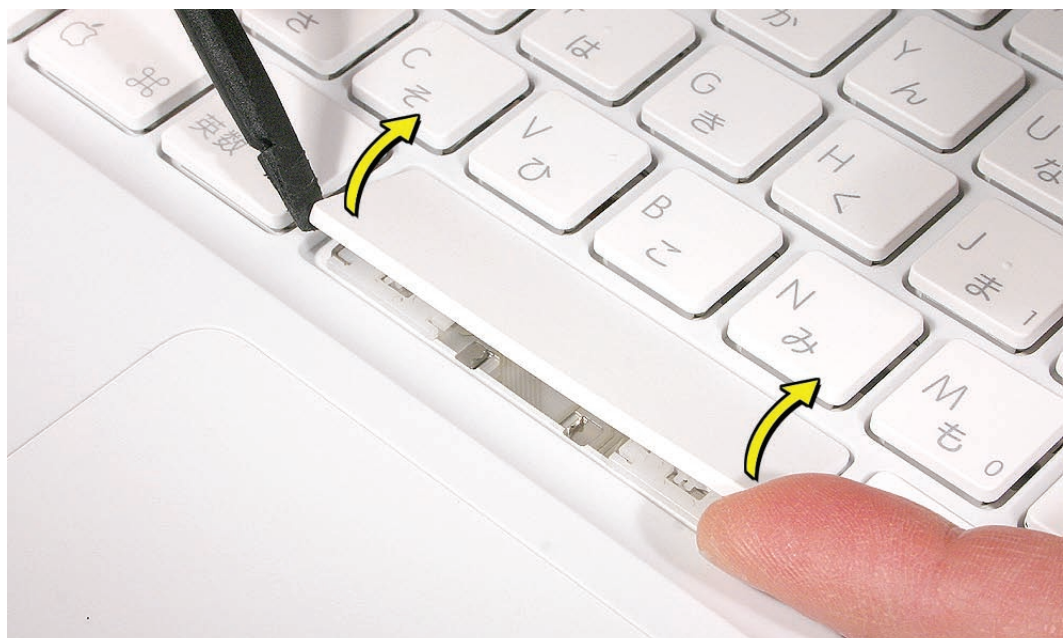

3. Because adhesive is used under the top case, closely inspect the case for any adhesive that may have built up under the keycap. Lift away any built-up adhesive using fine-point tweezers.

4. Check that the longest stabilizer bar can pivot easily within the three hooks of the keycap.

- If any of the hooks or clips are bent, broken, or missing, replace the keycap.
- If the hooks and clips are intact, re-use the keycap.

5. Check the rubber dome inside the keycap well on the top case.

- When the rubber dome is pressed and released, it should spring back upright.
- If the rubber dome is off center or damaged, replace the top case.

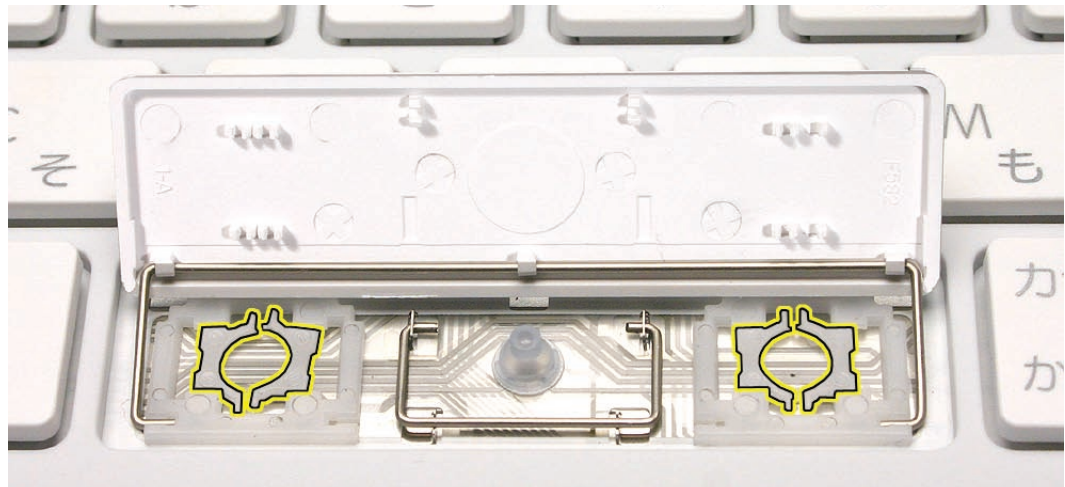

6. With the stabilizer bar open, make sure the two ends of the slider bar are secured into the slots in the keycap well.

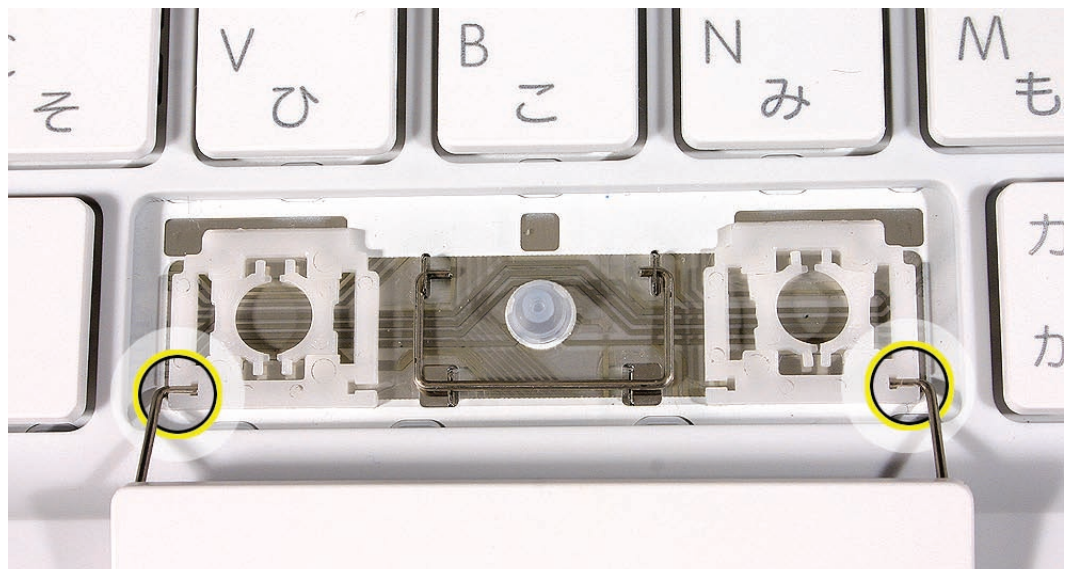

7. Make sure the dual-hinge mechanism on both ends of the keyboard well is fully flat and pressed as far apart they will go. Then lower the keycap so that the clips align with the smaller stabilizer bar and the center of the hinge mechanism.



8. Lower the key down.



9. Press the major contact points, and then press over the entire key to hear it snap into place.

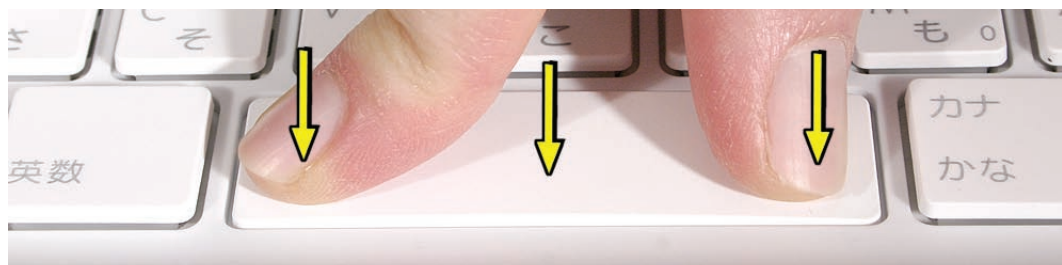

10. Check the Space bar key from all angles to make sure it is uniformly flat. Press and release one corner of the key. If it is installed correctly, the opposite corner should move at the same level.

Apple Service Source



Troubleshooting
MacBook (13-inch)



General Information

The kinds of problems you might see when troubleshooting this computer include:

- Unit Unusually Hot
- Disc Will Not Eject
- Microsoft Office Applications Will Not Open
- Windows XP Will Not Install Correctly
- Computer Will Not Start, LED Blinks
- Optical Drive Does Not Work
- Keycap Damaged
- Power Issues, Power Adapter Dead, No Power

In the next section we will discuss the individual troubleshooting steps as they apply to this product. As a reminder, the troubleshooting steps are:

1. Gather information
2. Verify the problem
3. Try quick fixes
4. Run diagnostics
5. Try systematic fault isolation
6. Research
7. Escalate
8. Repair or replace
9. Verify the repair
10. Inform the user
11. Complete administrative tasks

Note: If you are not familiar with the [Apple General Troubleshooting Flowchart](#), see the self-paced course [General Troubleshooting Theory](#).



Troubleshooting Steps

You perform the first few steps of troubleshooting regardless of whether there is a repairable problem or damage.



Gather Information

Gather the normal information about the problem. (If you are not familiar with the normal information to gather, or any of the other steps, see [General Troubleshooting Theory](#).)



Verify the Problem

Verify that the symptom exists as the customer reports it.



Try Quick Fixes

Special quick fixes that apply to this computer include:

- Familiarize yourself with normal operating temperature (see Knowledge Base document [30612](#))
- Use firm pressure to seat memory (see Knowledge Base document [303721](#))
- Reset the power manager (See Knowledge Base document [303319](#)).

For more details, see the Symptom Charts section.



Run Diagnostics

The following diagnostic tools are available for this product:

- Apple Hardware Test
- Apple Service Diagnostic

See Knowledge Base document [112125](#), “Service Diagnostic Matrix”, to download the appropriate disc image.



Try Systematic Fault Isolation

There are no special systematic fault isolation techniques for this product.



Research

If you have not located the trouble following the steps thus far, try researching the symptoms.

Research resources include:

- Symptom Charts section of this manual
- GSX
gsx.apple.com
Enter serial number and click Coverage Check
- Service Source
service.info.apple.com
Check Quick Links and/or Technical Resources
Check options under appropriate Product Service pop-up menu
- Product support page
service.info.apple.com
Choose MacBook Support Page from the appropriate Product Service pop-up menu
- Knowledge Base
search.info.apple.com
keyword kmb
- Self-paced service training
service.info.apple.com
Choose Service Training from the Product Service pop-up menu

Escalate

Follow the practices and policies of your business or agency.



Repair or Replace

Once you locate the trouble you will most likely need to repair the unit, or mail it in to an AppleCare Repair Center, depending on the service strategy in your region. Be sure to include the CompTIA code, the troubleshooting steps you performed, and the results in the Service Instructions section of GCRM and/or GSX.

If the symptoms point to a component on the logic board, use the [block diagram](#) at the end of this chapter to help determine whether you need to replace the entire logic board.

Also be aware of the following parts that customers may replace themselves (known as Do-It-Yourself parts):

- Hard drive
- AC adapter
- RAM
- Battery

Note: For the current list of Do-It-Yourself parts, see the product support website.



Verify the Repair

To verify the repair:

1. Try to recreate the original symptoms. You should not be able to. (If you can, return to the beginning of the troubleshooting flowchart.)
2. Perform the preventive maintenance tasks for this product.
For this computer this includes only cleaning the display and case.



Inform the User

Include in the case notes all that you have done. The customer may like a copy of any diagnostic reports.

Important: For any unit you send on to a repair center, include the CompTIA code, symptoms, steps to reproduce, and troubleshooting steps you have completed thus far in the Service Instructions section of GCRM and/or GSX. (Service Instructions are also known as FAI notes.)

Complete Administrative Tasks

There are no particular administrative tasks for this product, other than those required by the internal policies of your business or agency.



Symptom Charts

When to Use the Symptom Charts

Before turning to the symptom charts, you should have completed the following steps on the Apple General Troubleshooting Flowchart:

1. Gather information
2. Verify the problem
3. Try quick fixes

You consult the symptom charts as part of the Research troubleshooting step (and sometimes as part of the Try Quick Fixes step).

How to Use the Symptom Charts

The Symptom Charts included in this chapter will help you diagnose specific symptoms related to the product. Cures are listed on the charts in the order of most likely solution: try the cures in the order presented. Verify whether or not the product continues to exhibit the symptom. If the symptom persists, try the next cure.

Note: If a step instructs you to replace a module, reinstall the original module before you proceed to the next step.

AirPort Extreme Card not recognized

1. Use Software Update in Mac OS X system preferences or see the Apple Software Updates web page to make sure the latest version of AirPort software is installed.
2. Check Network pane in System Preferences to verify AirPort port is selected.
3. Reseat AirPort Extreme Card and make sure AirPort antenna cables are fully connected.
4. Remove and reinstall the AirPort software.
5. Replace with known-good AirPort Extreme Card.
6. Replace logic board.

Poor AirPort reception

Refer to Knowledge Base article [88258](#) "PowerBook G4: How to Optimize AirPort reception".

-
1. Reseat AirPort Extreme and Bluetooth antenna cables on cards.
 2. Check AirPort Extreme and Bluetooth antenna cables for damage.
 3. Replace with known-good AirPort Extreme Card or Bluetooth card.
 4. Replace AirPort Extreme or Bluetooth antenna cables.

Unit unusually hot

This computer runs hotter than previous models. However, the normal operating temperature is well within national and international safety standards. Nevertheless, customers may be concerned about the generated heat. To prevent an unneeded repair, you can compare a customer's computer to a running model, if available, at your repair site.

1. Verify that the customer uses the computer while it is placed on a flat, hard surface.
2. Verify that the computer is hotter than expected for normal operation. If possible, compare how hot the computer case feels with how hot the case of a running display model feels.
3. Is the computer running hotter than normal?
Yes: Proceed to the next step.
No: The unit is operating normally. Proceed to the Inform Customer step on the flowchart. When speaking with the customer, direct him or her to Knowledge Base article [30612](#).
4. Check the processor speed.
5. Is the processor speed running at the setting the customer set?
Yes: Continue with the next step.
No: The computer could be overheating. The operating system will automatically reduce the processor speed if the computer starts to get too hot. Continue with the next step.
6. Check for a failed fan.
7. Can you hear the fan running?
Yes: Continue with the next step.
No: This computer has only one fan. If the unit feels too hot and you do not hear a fan running or cannot feel the air venting over the top of the keyboard, the fan may have failed. Proceed to the Take Apart procedure for replacing the fan.
8. Check for misplaced thermal grease.
Each processor chip should have .01 to .12 cc (one-third of a single syringe) of grease on it. It should look completely covered. See the Heatsink section of the Take Apart chapter for complete details.
9. Is the thermal grease applied in the right places and in the right amount, according to the service manual?
Yes: You have eliminated all the immediately known potential causes of an unusually hot unit. Proceed to the Systematic Fault Isolation step of the troubleshooting flowchart.
No: Apply the thermal grease correctly, according to the instructions in the service manual then proceed to the Verify Repair step of the troubleshooting flowchart.

For more information on the operating temperature of Apple portable computers, see Knowledge Base article [30612](#), “Apple Notebooks: Operating Temperature.” You may also want to point out this article to the customer.

Fan fails

1. Check fan cable connection, and check cable for damage.
2. Check fan for loose parts stuck in fan blades.
3. Replace fan.
4. Replace logic board.

Disc will not eject

The optical drive on this computer has narrow tolerances for the recommended optical media. If the drive does not accept discs, the wrong kind of disc could be inserted. Advise customer to use discs no thicker than 1.5 mm. See Knowledge Base article [88275](#), “MacBook Pro, MacBook, PowerBook G4, iBook G4: Troubleshooting the slot load disc drive.”

1. Verify disc is not in use by quitting any applications that may be using the disc.
2. Press and hold Media Eject key at top right corner of keyboard. If that does not work, hold down Function (fn) key and Media Eject key.
3. Drag disc icon to trash or select it and press Command-E.
4. Choose Restart from Apple menu while holding down trackpad button.
5. Replace the optical drive.
Related Knowledge Base article: 106752: Macintosh: How to Eject a Disc When Other Options Do Not Work

Memory not recognized; beeping tones

You may need to use increased firm pressure when installing memory. If you or the customer do not fully seat the memory the computer will not start up, or System Profiler may not recognize the memory. See Knowledge Base article [303721](#) “MacBook (13-inch): How to install memory.”

Computer will not start; LED blinks or remains on

1. You may need to use increased firm pressure when reseating memory. Try ejecting the memory and reseating it.
2. Try known-good memory.

If you or the customer do not fully seat the memory, the computer will not start up. See Knowledge Base articles [303083](#), “Intel-based Mac Power On Self Test RAM error codes,” and [303721](#), “MacBook (13-inch): How to install memory.”

Battery won't charge

1. Remove any connected peripherals.
2. Try known-good power outlet.
3. Try known-good power adapter and power cord.
Note: Verify that power adapter connector glows amber or green. If the power adapter light is green, turn over the computer and press the battery button. The battery lights should glow green and stay on if the power adapter is operating correctly.
4. Try known-good battery.
5. Reset the power manager by pressing the key combination Control-Option-Shift-power.
Warning: Make sure you do not hold down the "fn" key when resetting the power manager.
Warning: Resetting the power manager means you will also need to reset the date and time (using the Date & Time control panel).
6. Try known-good DC-in board and cable assembly.
7. Replace battery transfer board.
8. Replace logic board.

Optical drive does not work

There are four clips at the optical drive bezel that can come loose during disassembly or reassembly. If any come loose, they could cause the optical drive to fail to function.

If, after trying other less invasive quick fixes, the optical drive still does not function, remove the top case and check that the four clips at the optical drive bezel (shown below) are in place. See [Top Case](#) in the Take Apart chapter.

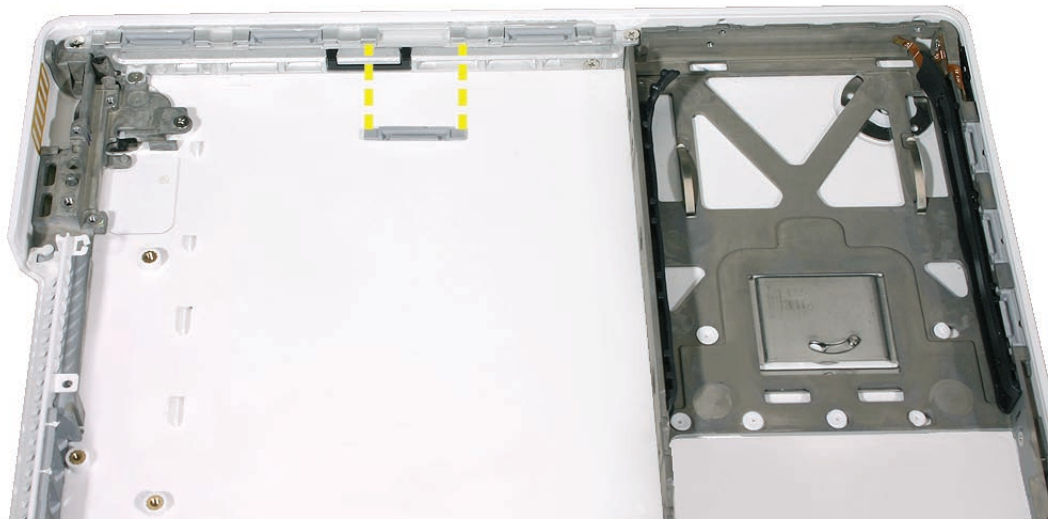

Optical drive does not accept CD or DVD disc (mechanical failure)

1. Verify disc is not warped.
2. Verify drive slot has no foreign object in channel.
3. Verify disc is properly seated in the carrier.
4. Replace optical drive.
See Knowledge Base article [88288](#) "Apple Portables: Tips for inserting discs into the disc drive."

Disc icon does not show up on desktop, or a dialog box appears to initialize disc

1. Verify the correct type of disc is being used.
2. Try cleaning the disc. It may not mount if dirty or scratched.
3. Verify media is positioned correctly: data side down.
4. Try a different disc.
5. Listen to verify that the disc spins.
6. Reseat optical drive cable.
7. Verify the logic board connection by trying a known-good optical drive and disc.
8. Replace optical drive cable.
9. Replace optical drive.

Combo drive does not write at maximum speed

Refer to Knowledge Base article [86186](#): "PowerBook G4, iBook: Combo Drive Does Not Write CD-R Media at Maximum Speed".

Keycap damaged or sticking

If a keycap is damaged, you may be able to replace just a keycap rather than the entire top case. Refer to the Additional Procedures chapter to identify the keyboard on the top case and verify whether or not to replace a keycap.

Power issues, power adapter dead, no power

1. Check for damaged pins or magnetic debris on MagSafe power adapter. If pins are okay, reseat power adapter connector and make sure it is fully inserted. Refer to Knowledge Base articles [303566](#) "MacBook Pro: Troubleshooting MagSafe power adapters with stuck pins" and [302461](#) "Troubleshooting iBook, PowerBook G4, and MacBook Pro power adapters".

-
2. Remove any connected peripherals.
 3. Try known-good power outlet.
 4. Remove battery, and remove AC power.
 5. Press Caps Lock key to see if light on key comes on. If it does, hold power button down for six seconds to shut down the computer and restart.
 6. Reset PRAM (Press the power button, then hold down the Option-Command-P-R keys until you hear the startup chime at least one additional time after the initial startup chime).
 7. Reset the power manager. See Knowledge Base article [303319](#), “Resetting MacBook Pro Power Management Unit (PMU):”
Warning: Make sure you do not hold down the “fn” key when resetting the power manager. Resetting the power manager means you will also need to reset the date and time (using the Date & Time pane of System Preferences).
 8. Test each RAM slot individually with known-good RAM. (The computer should still start with only one known-good DIMM.)
 9. Remove AirPort Extreme Card.
 10. If computer starts on battery power only, try replacing MagSafe board with a known-good MagSafe DC-in board.
 11. Verify cable connections and check cables for damage.
 12. Verify power button is connected properly to logic board, if power button is not functioning correctly or damaged, replace the top case.
 13. Replace logic board.

Computer shuts down intermittently

Apple has released SMC version 1.1 for the MacBook, which improves the computer’s internal monitoring system and addresses issues with unexpected shutdowns. This update is recommended for all MacBook systems, including those that received warranty repair. Effective immediately, when repairing MacBook computers with an intermittent shutdown failure, follow the procedure outlined below.

1. Make sure the operating system has been updated to Mac OS X 10.4.8 or later and that SMC version 1.1 (or later) has been installed. If so, go to the next step.
2. Remove all third-party internal and external devices from the computer and test again. If the issue still occurs, go to the next step.
3. Reseat the computer’s system memory and test again. If the issue still occurs, go to the next step.
4. Make sure you are testing from a known-good power adapter and a known-good battery that is fully charged.
5. If the intermittent shutdown symptom persists after completing the steps above AND the

black or white MacBook is within the serial number range xx617xxxxxx - xx635xxxxxx, Apple will replace the heatsink under warranty.

Important: Do not disclose serial number ranges to customers. Order the following part for all MacBook computers exhibiting this behavior:

076-1243 Heatsink Kit, with Sponge, 1.0 mm Conn

Note: The kit includes the heatsink, heatpipe sponge, and connector pressure-foam pad.

More details about the MacBook intermittent shutdown issue is available in Knowledge Base article [304308](#) "MacBook: Shuts down intermittently".

Trackpad works intermittently

The trackpad operation can be affected by hand lotion, humidity, dangling jewelry, and the use of more than one finger on the trackpad.

1. Check for environmental factors such as humidity, hand lotion, or jewelry.
2. Clean the trackpad with a clean, dry lint-free cloth.

For more information, see Knowledge Base articles: [17228](#): "Portables: Jumpy or Erratic Trackpad Operation"; [58389](#): "PowerBook and iBook: Trackpad Does Not Respond".

USB port is not recognizing known devices

1. Completely shut down, then press the power button to start the computer.
2. Use Software Update in Mac OS X system preferences to verify that the latest software is installed.
3. Use Apple System Profiler to verify that the computer is recognizing the bus.
4. Test USB port with an Apple keyboard or mouse.
5. Verify USB port provides power to USB device.
6. Verify that drivers are installed properly for third party, if needed.
7. Try other port if available.
8. Try a different cable.
9. Try known-good device.
10. Check that device's LED indicates that it is getting power.
11. Replace logic board.

Display Issue: When displaying a single color over the screen area, the LCD panel shows one or more pixels that are not properly lit

To determine whether or not the display has an acceptable number of pixel anomalies, follow the steps below:

1. Set the display image to one of the following colors: all-white display, all-red display, all-green display, or all-blue display. Knowledge Base article [112125](#): “Service Diagnostics Matrix,” has the LCD Tester Diagnostic Utility that will generate these patterns on the screen.
2. Using a jeweler’s loupe, pocket microscope, or other magnifying device, identify and count each pixel anomaly:
 - Bright subpixel anomaly = subpixel that is always on
 - Dark subpixel anomaly = subpixel that is always off
3. The number of acceptable pixel anomalies for this computer is:

Acceptable Number of Subpixel Anomalies

Bright	Up to 3
Dark	Up to 5
Combination	Up to 7

4. If the number of subpixel anomalies exceeds the acceptable number listed in the above chart, replace the LCD panel.

Replace the LCD Panel if...

Bright	4 or more
Dark	6 or more
Combination	8 or more

5. If the number of subpixel anomalies is acceptable, explain to the customer that the pixel anomalies are within specifications, and no repair is necessary.

Important: Do not release the specifications to customers. Instead, inform them that a certain number of subpixel anomalies are considered acceptable, and these factors apply to all manufacturers using LCD technology—not just Apple products.

When speaking with customers, please use the following explanation:

Active-matrix LCD technology uses rows and columns of addressable locations (pixels) that render text and images on screen. Each pixel location has three separate subpixels (red, green, and blue) that allow the image to be rendered in full color. Each subpixel has a corresponding transistor responsible for turning the subpixel on or off.

There are typically millions of these subpixels on an LCD display. For example, the LCD panel used in the Apple Cinema HD display is made up of 2.3 million pixels and 6.9 million red, green, and blue subpixels. Occasionally, a transistor does not work perfectly, which may result in the affected subpixel being turned on (bright) or turned off (dark). With the millions of subpixels on a display,

it is quite possible to have a low number of faulty transistors on an LCD. Therefore, a certain number of subpixel anomalies are considered acceptable. Rejecting all but perfect LCD panels would significantly increase the retail price for products using LCD displays. These factors apply to all manufacturers using LCD technology—not just Apple products.

No display, or dim display, but computer appears to operate correctly (if dim, display shows startup icon and/or desktop)

1. Remove any connected peripherals.
2. Try known-good power outlet, power adapter and power cord.
3. Press F2 (with the fn key pressed and not pressed) to increase the screen brightness setting.
4. Reboot the computer—hold down the Control and Command keys and press the Power button, or press and hold the Power button for 5 to 10 seconds to shut down the computer, then press the Power button to restart.
5. Reset the power manager by pressing the key combination Control-Option-Shift-power.
Warning: Make sure you do not hold down the “fn” key when resetting the power manager.
Warning: Resetting the power manager means you will also need to reset the date and time (using the Date & Time control panel).
6. Reset PRAM (Press the power button, then hold down the Option-Command-P-R keys until you hear the startup chime at least one additional time after the initial startup chime).
7. Connect an external display, and check for video on external display.
8. If video is fine on external display, troubleshoot LCD panel and verify cable connections to inverter and LCD.
9. If video symptom is same on external display, replace logic board.
10. Verify LCD panel cable and LVDS cable connections are seated properly and that the cables are not damaged.
11. Replace LCD panel.
12. Verify cable connections and check cables around the hinges for damage.
13. Replace logic board.

Distorted sound from speaker(s)

1. Verify sound is correct with external speakers/headphones. If sound is correct, replace top case.
2. Verify speaker cables are inserted correctly, and check cables for damage.
3. Check balance in System Preferences: Sound: Output.
4. Compare same sound with two different units to make sure that sound is actually distorted.
5. In System Preferences, open Sound, select Output, and set the slider bar to either the

left or right speaker. Play a sound to tell which speaker is not responding and may need replacement. Based on results, replace either the left or right speaker.

6. Replace logic board.

No sound from speaker(s)

1. Reset PRAM (Press the power button, then hold down the Option-Command-P-R keys until you hear the startup chime at least one additional time after the initial startup chime).
2. Verify that the speaker cables are connected properly to logic board, and check cables for damage.
3. Use the Software Update control panel to verify that the latest audio update has been installed.
4. Press the F3 key (with the fn key pressed and not pressed) to verify that mute mode is not enabled.
5. Press the F4 or F5 key (with the fn key pressed and not pressed) to check the volume setting.
6. Verify no external speakers or headphones are plugged in.
7. Shut down computer and restart.
8. In System Preferences, open Sound, select Output, and set the slider bar to either the left or right speaker. Play a sound to tell which speaker is not responding and may need replacement. Based on results, replace either the left or right speaker.
9. Replace logic board.

Related article: [58463](#): iBook: Sound Capabilities

Microsoft Office applications will not open

Under certain circumstances, if a user installs Final Cut Studio 5.1, Microsoft Office applications may no longer launch.

1. Verify that both Final Cut Studio 5.1 and Microsoft Office are installed, if you have not already done so.
2. Update pre-binding. See Knowledge Base article [303677](#), "Intel-based Mac: Microsoft Office doesn't launch," for instructions.

Windows XP will not install correctly

Boot Camp Beta lets you install Windows XP on an Intel-based Mac. However, Windows XP may not install correctly on this computer when an Apple Mighty Mouse is plugged in. Use the computer's built in trackpad until after Windows XP is installed and Windows recognizes the trackpad. See Knowledge Base article [303575](#), "Boot Camp Beta: MacBook Pro frequently asked questions (FAQ)".

Study the block diagram to understand which I/O ports have a direct connection to the outside world and which ports have an I/O interface controller between the system I/O mapper and the outside world.

For example, let us say you are troubleshooting an AirPort connectivity symptom. Input to the AirPort Extreme Card comes from the MLB. Power and addressing of the card are necessary for its operation. Microwave data output signal to the antenna is the desired output and this too is necessary for the card's operation. You have three components to check to discover fault with AirPort operation: MLB, AirPort Extreme Card, and antenna.

If installing a known-good AirPort Extreme Card restores operation, you need to focus on the original card. If the known-good card does not restore operation, you need to focus on the MLB or the original antenna.

When you focus on the MLB, from the block diagram, you can see that the MacBook (13-inch) AirPort Extreme Card is on the PCI Express bus. Investigate other devices on the PCI Express bus, such as the Ethernet controller. Determine if the Ethernet port is working. (System Profiler is a good tool to verify I/O.)

If the Ethernet port is working, the MLB is probably functioning; focus on the original AirPort antenna. As an additional test, if you can see both the known-good AirPort Extreme Card and original AirPort Extreme Card in System Profiler, suspect the antenna.

Service Source



Views

MacBook (13-inch)



External and Internal Views

Front: Keyboard and IR Window



Back: Air Vents and Display Clutch



Left Side: Ports



Right Side: Slot Drive



Battery Bay: Memory Card Levers and Hard Drive Pull Tab

Important: The following image shows the memory cards and hard drive installed in the battery bay with the L-shaped RAM door removed. Note the correct position of the memory card levers. Some images pictured in this manual used a pre-production model, so the direction and appearance of the levers differs from the accurate depiction shown.

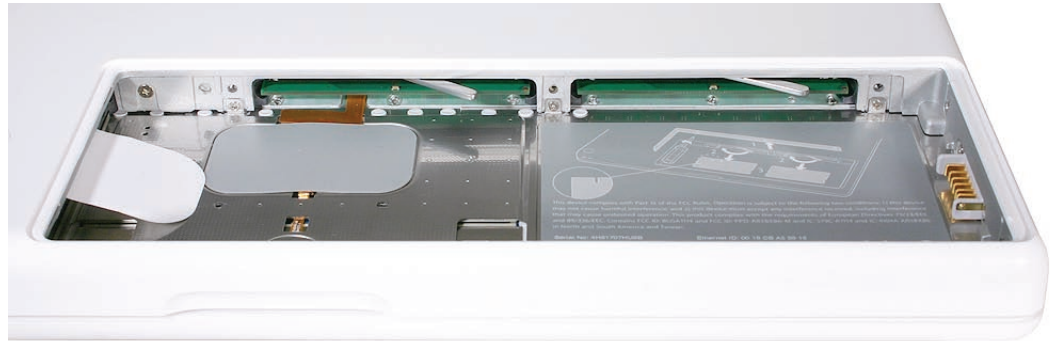

Top Case Removed: Main Modules and Cable Routing

Refer to the following images in this section for an accurate depiction of the main modules and cable routing with the top case off.

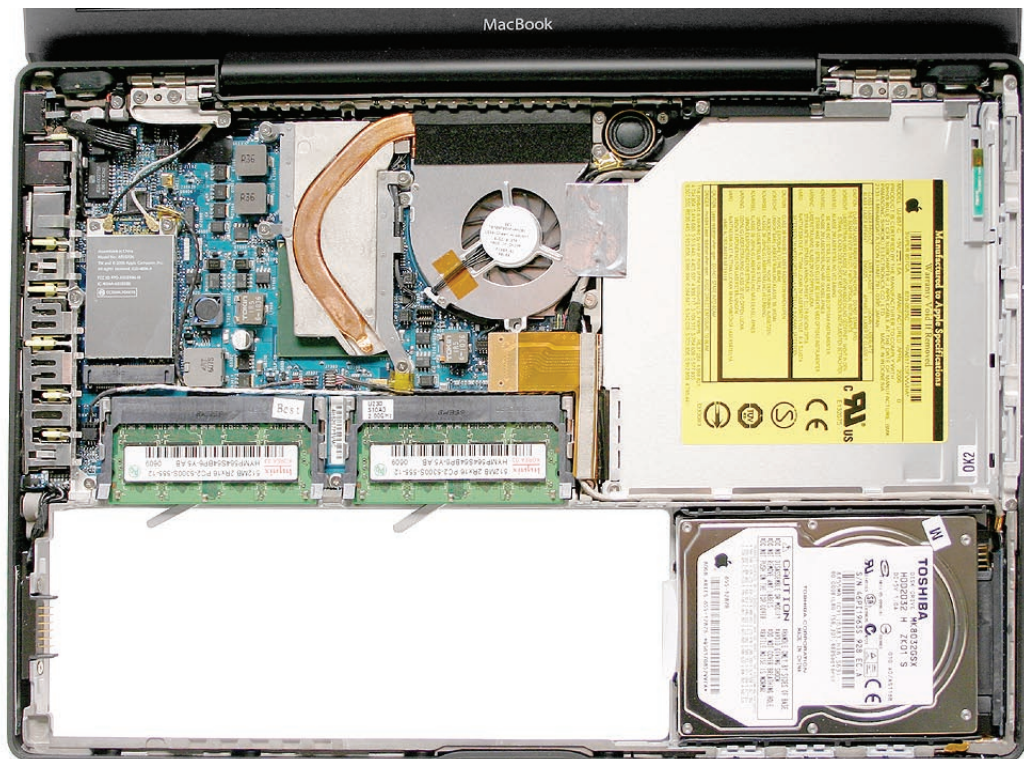

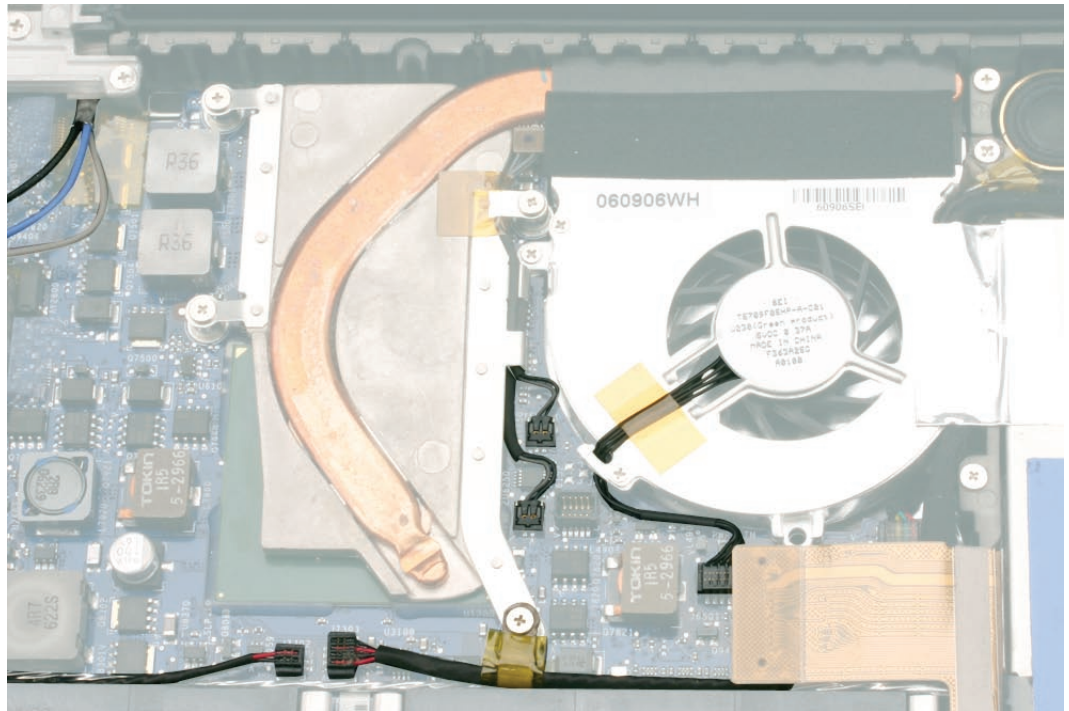
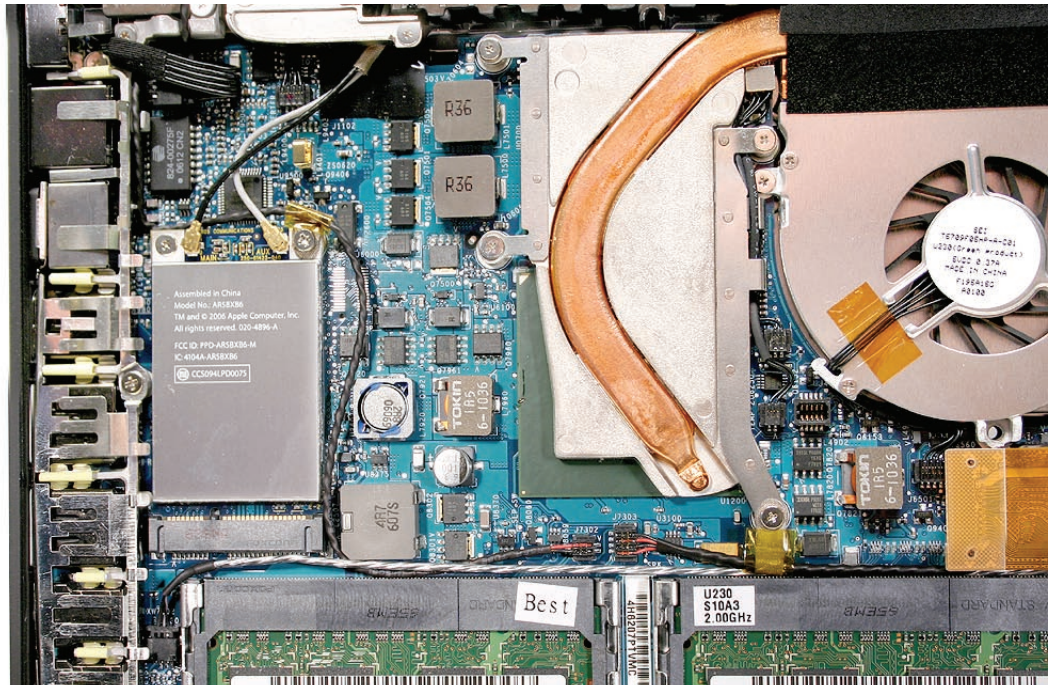

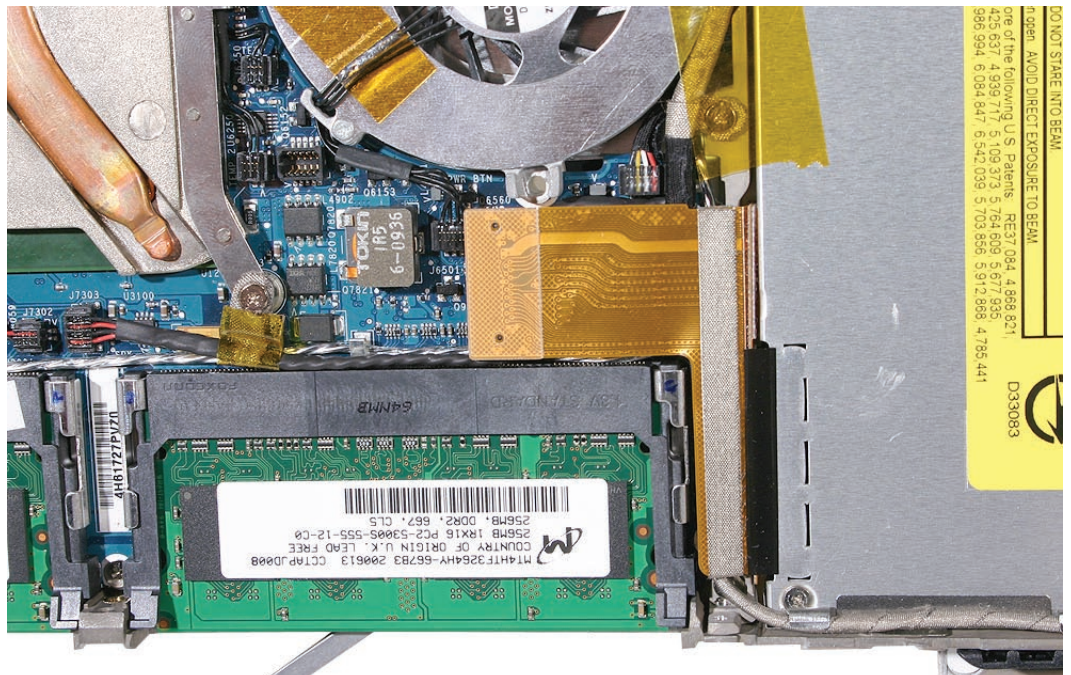
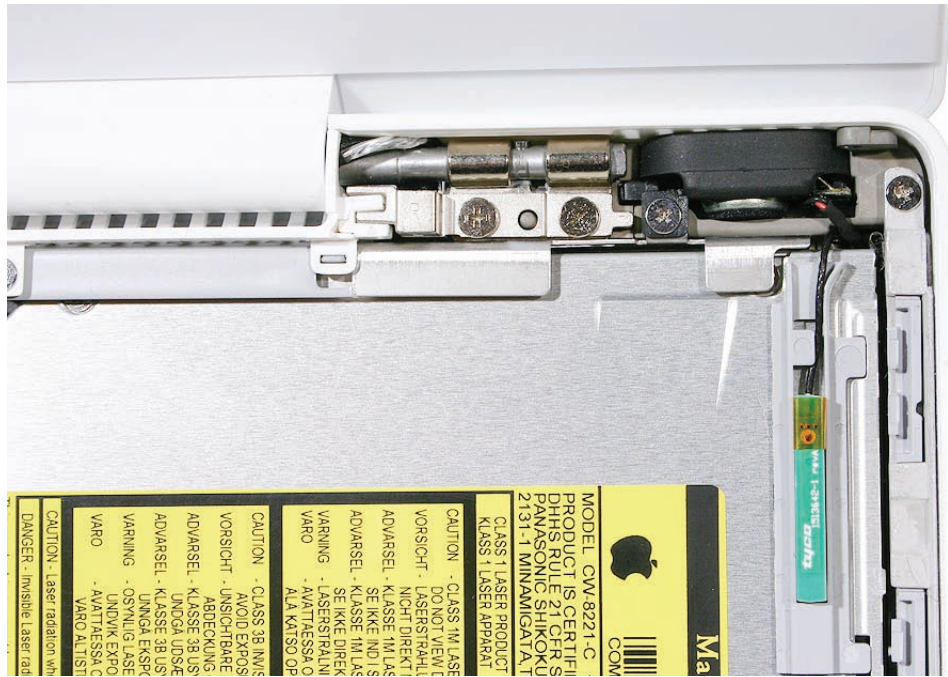

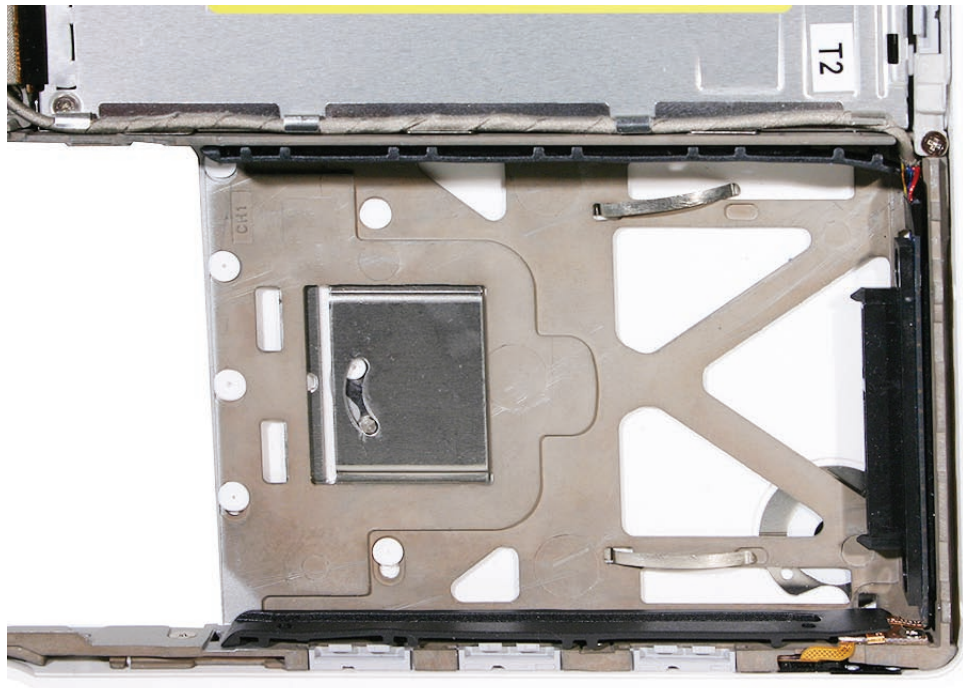
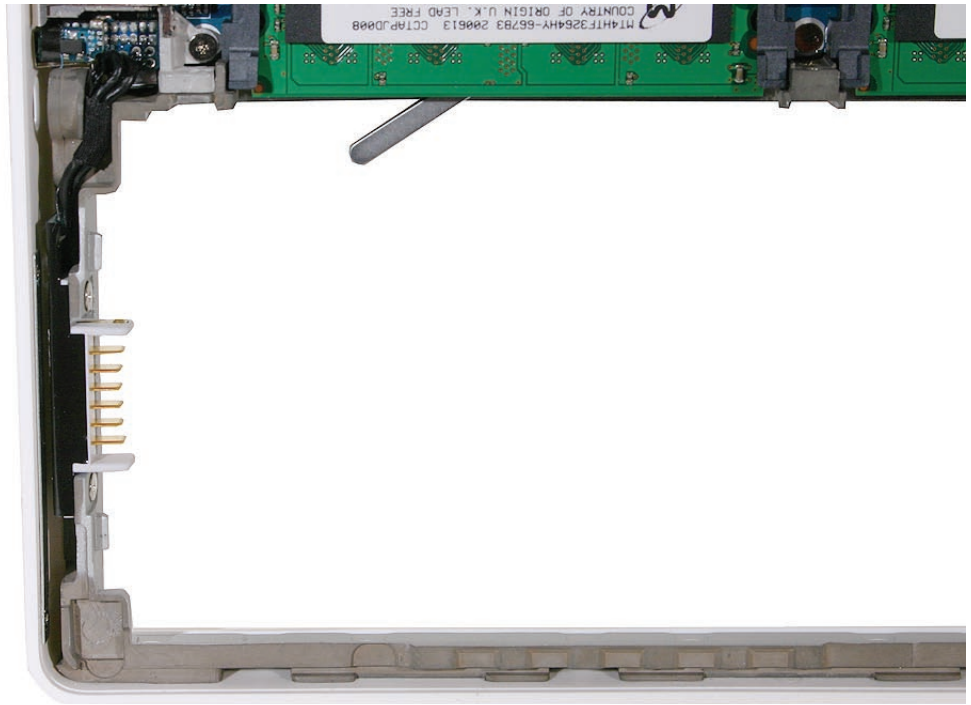

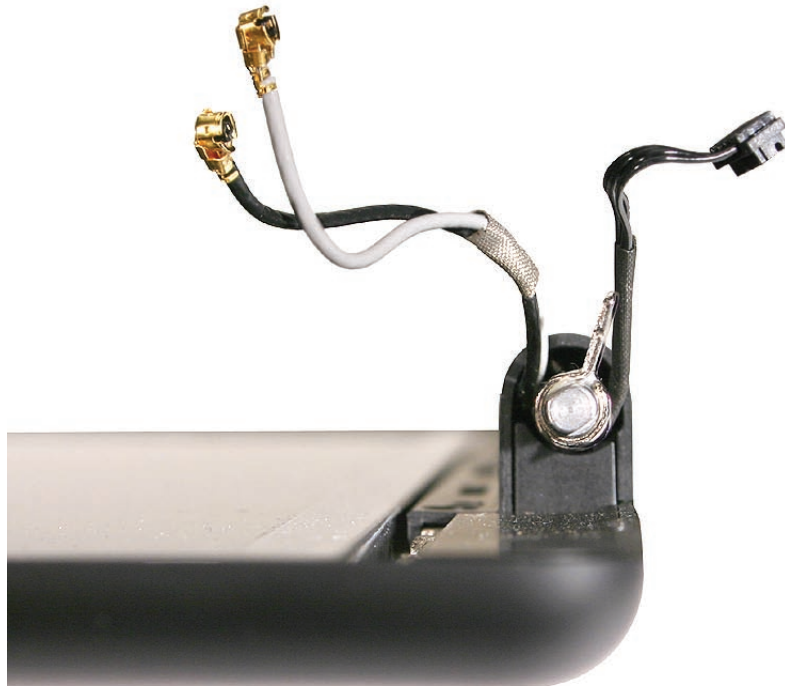

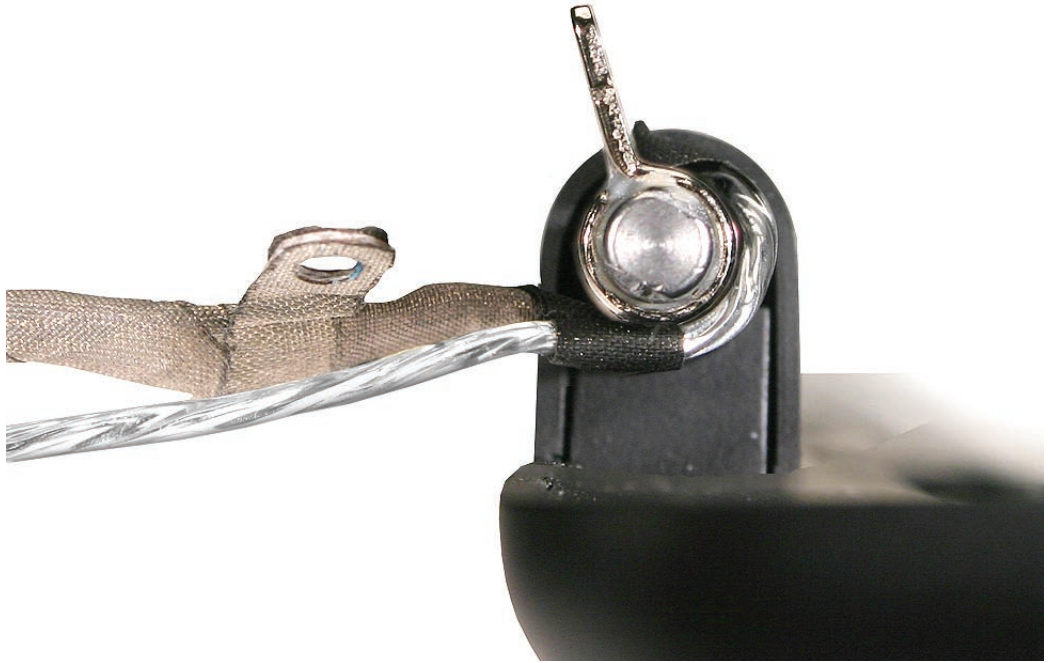



Screw Matrix

Top Case Screw Locations

Note: Screw lengths are approximate and cover the full length of the screw, including the screw head. Screw size, location, and part number details are subject to change. To offer a needed correction, click the Contact Us link on Service Source Online.

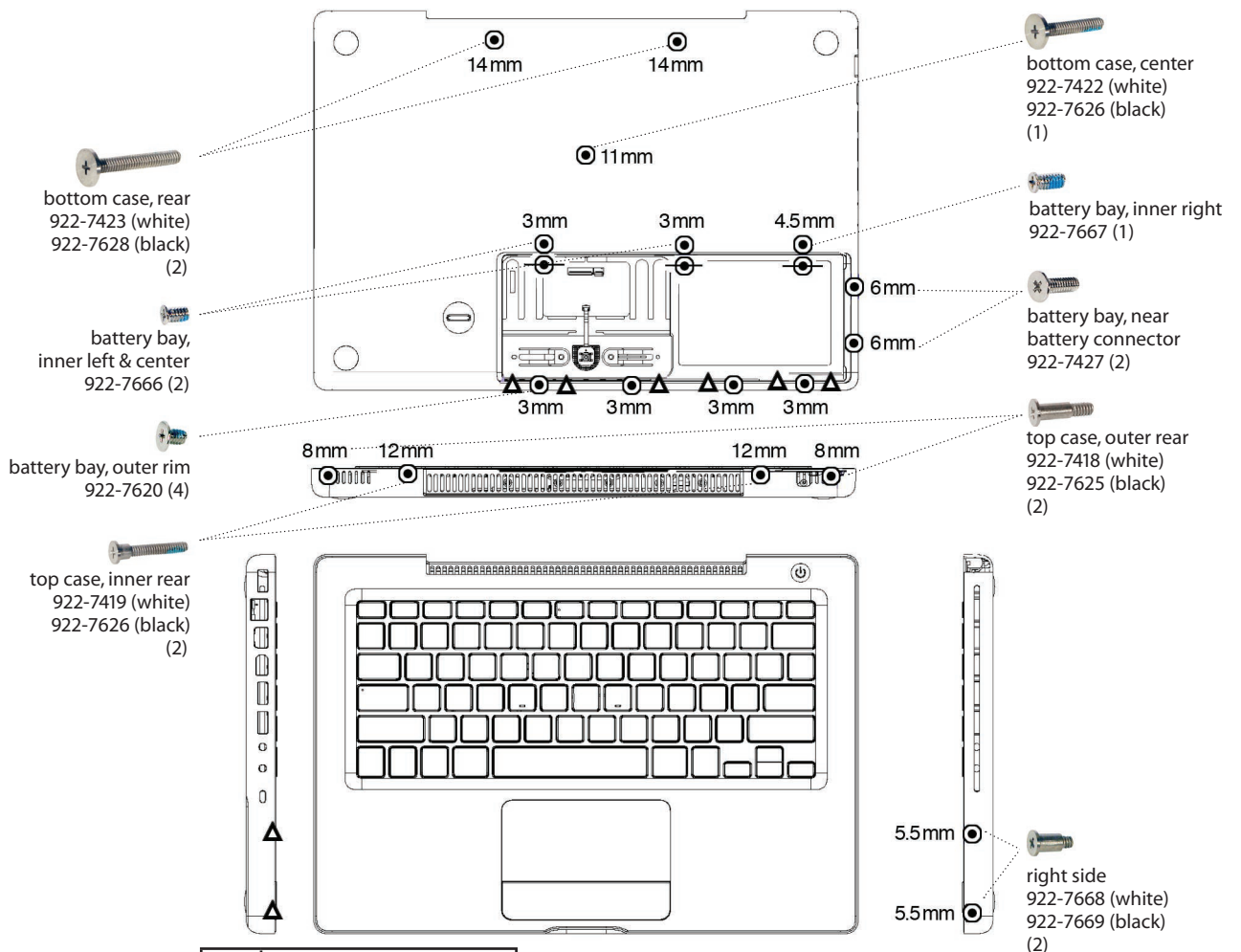

⦿	Remove screw
⊖	Captive screw
▲	Do not remove screw

Display Module Screw Locations

Note: Screw lengths are approximate and cover the full length of the screw, including the screw head. Screw size, location, and part number details are subject to change. To offer a needed correction, click the Contact Us link on Service Source Online.

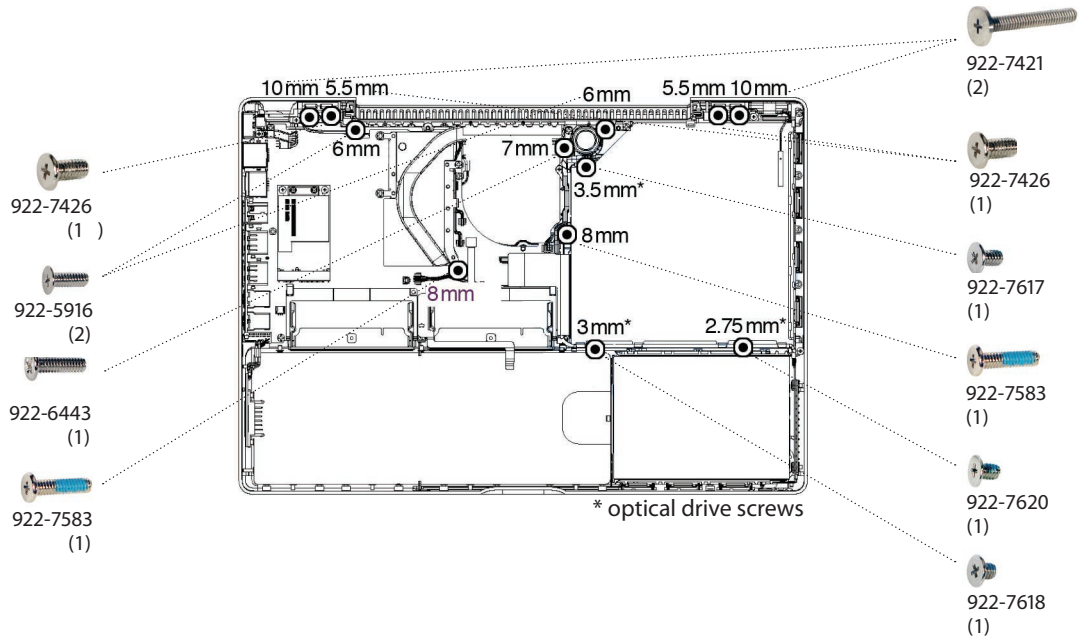

Optical Drive Bracket Screw Locations

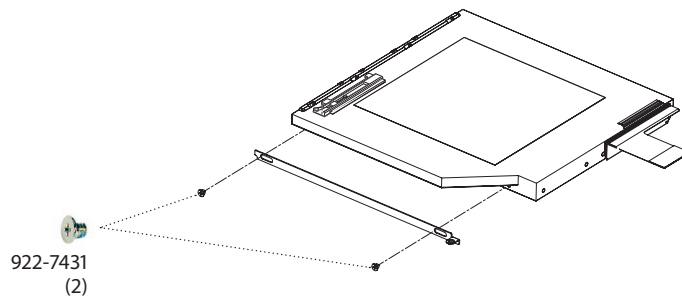

Logic Board Screw Locations



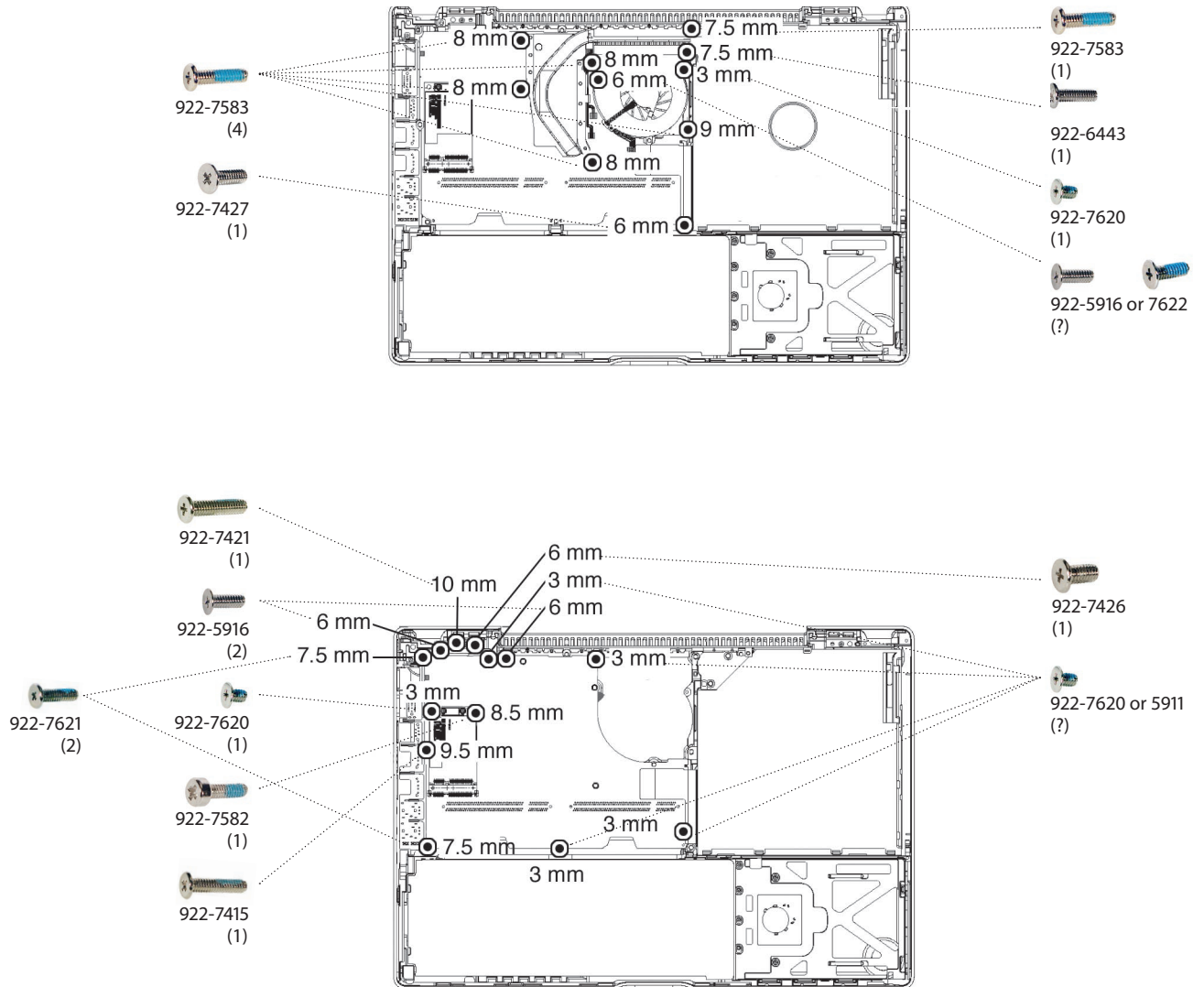



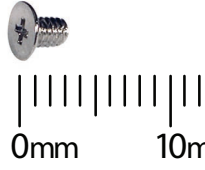
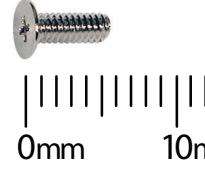
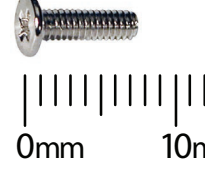
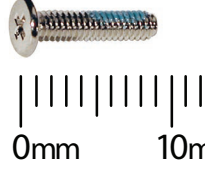
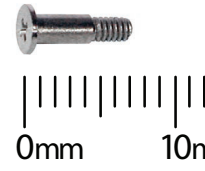
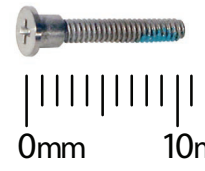
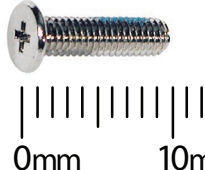
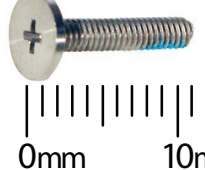
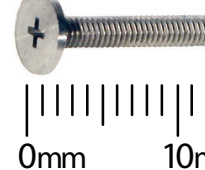
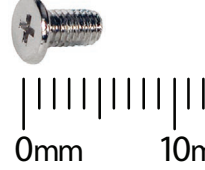
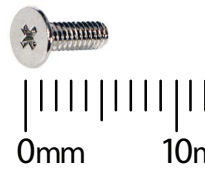
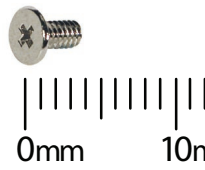



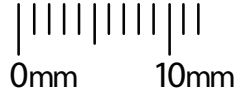

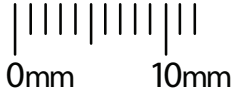

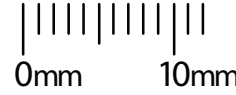

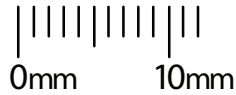



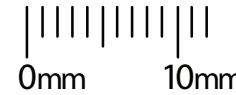

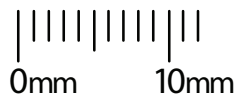
Note: Screw lengths are approximate and cover the full length of the screw, including the screw head. Screw size, location, and part number details are subject to change. To offer a needed correction, click the Contact Us link on Service Source Online.

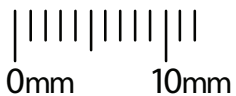

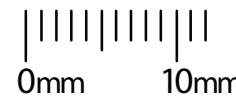
Screw Reference Chart, Part 1 of 2

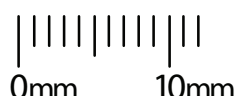
<p>922-5911 Phillips #0</p>  <p>interchangeable w/ 922-7620? (except no nylock coating)</p>	<p>922-5916 Phillips #0</p>  <p>fan (upper left corner), MLB, left clutch block</p>	<p>922-6443 Phillips #0</p>  <p>Bluetooth-to-logic board cable, subwoofer, midframe</p>
<p>922-7415 Phillips #0</p>  <p>I/O frame</p>	<p>922-7418 Phillips #0</p>  <p>top case (back, near corner)</p>	<p>922-7419 Phillips #0</p>  <p>top case (back, near hinge)</p>
<p>922-7421 Phillips #0</p>  <p>MLB, left & right clutch blocks</p>	<p>922-7422 Phillips #0</p>  <p>top case (bottom case, rear)</p>	<p>922-7423 Phillips #0</p>  <p>top case (bottom case, ctr)</p>
<p>922-7426 Phillips #0</p>  <p>MLB, left & right clutch blocks</p>	<p>922-7427 Phillips #0</p>  <p>battery bay, midframe</p>	<p>922-7429 Phillips #0</p>  <p>display assembly</p>

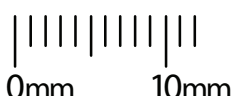
Screw Reference Chart, Part 2 of 2

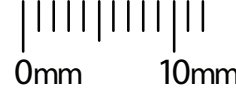
<p>922-7430 Torx T8</p>   <p>0mm 10mm</p> <p>hard drive assembly</p>	<p>922-7431 Phillips #0</p>   <p>0mm 10mm</p> <p>optical drive assembly</p>	<p>922-7582 Phillips #0</p>   <p>0mm 10mm</p> <p>Airport card, upper rt corner</p>
<p>922-7583 Phillips #0</p>   <p>0mm 10mm</p> <p>heatsink, midframe</p>	<p>922-7590 Phillips #0</p>   <p>0mm 10mm</p> <p>LCD assembly</p>	<p>922-7617 Phillips #0</p>   <p>0mm 10mm</p> <p>optical drive, upper left corner</p>
<p>922-7618 Phillips #0</p>   <p>0mm 10mm</p> <p>optical drive, right side</p>	<p>922-7620 Phillips #0</p>   <p>0mm 10mm</p> <p>battery bay, BT, speakers, etc.</p>	<p>922-7621 Phillips #0</p>   <p>0mm 10mm</p> <p>I/O frame, top/bottom ends</p>
<p>922-7666 Phillips #0</p>   <p>0mm 10mm</p> <p>battery bay, inner edge, left and center</p>	<p>922-7667 Phillips #0</p>   <p>0mm 10mm</p> <p>battery bay, inner edge right</p>	<p>922-7668 (white) Phillips #0 922-7669 (black)</p>   <p>0mm 10mm</p> <p>top case, right side</p>



Exploded Views

MacBook (13-inch)—Display Exploded View

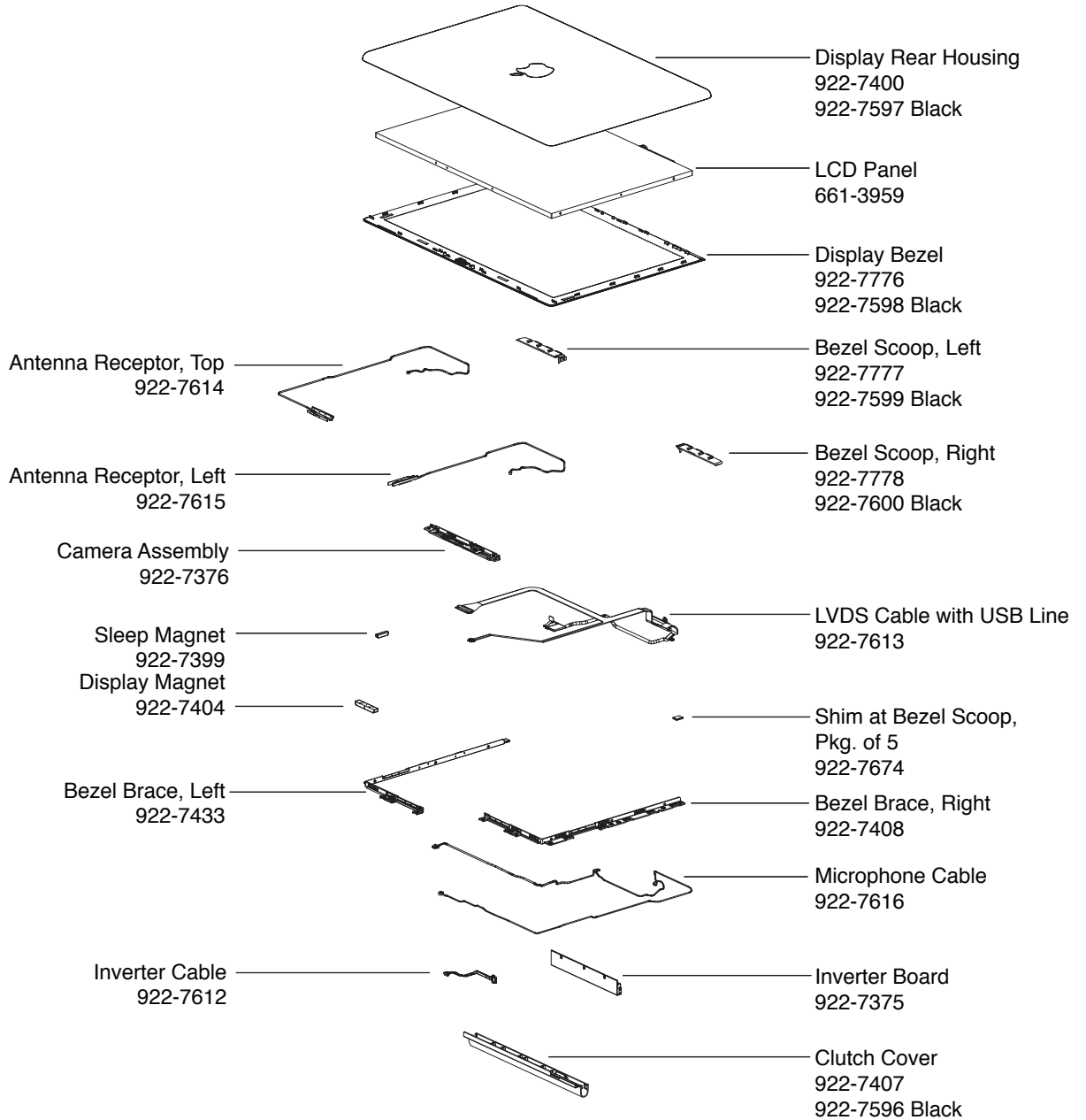

MacBook (13-inch)—Main Exploded View

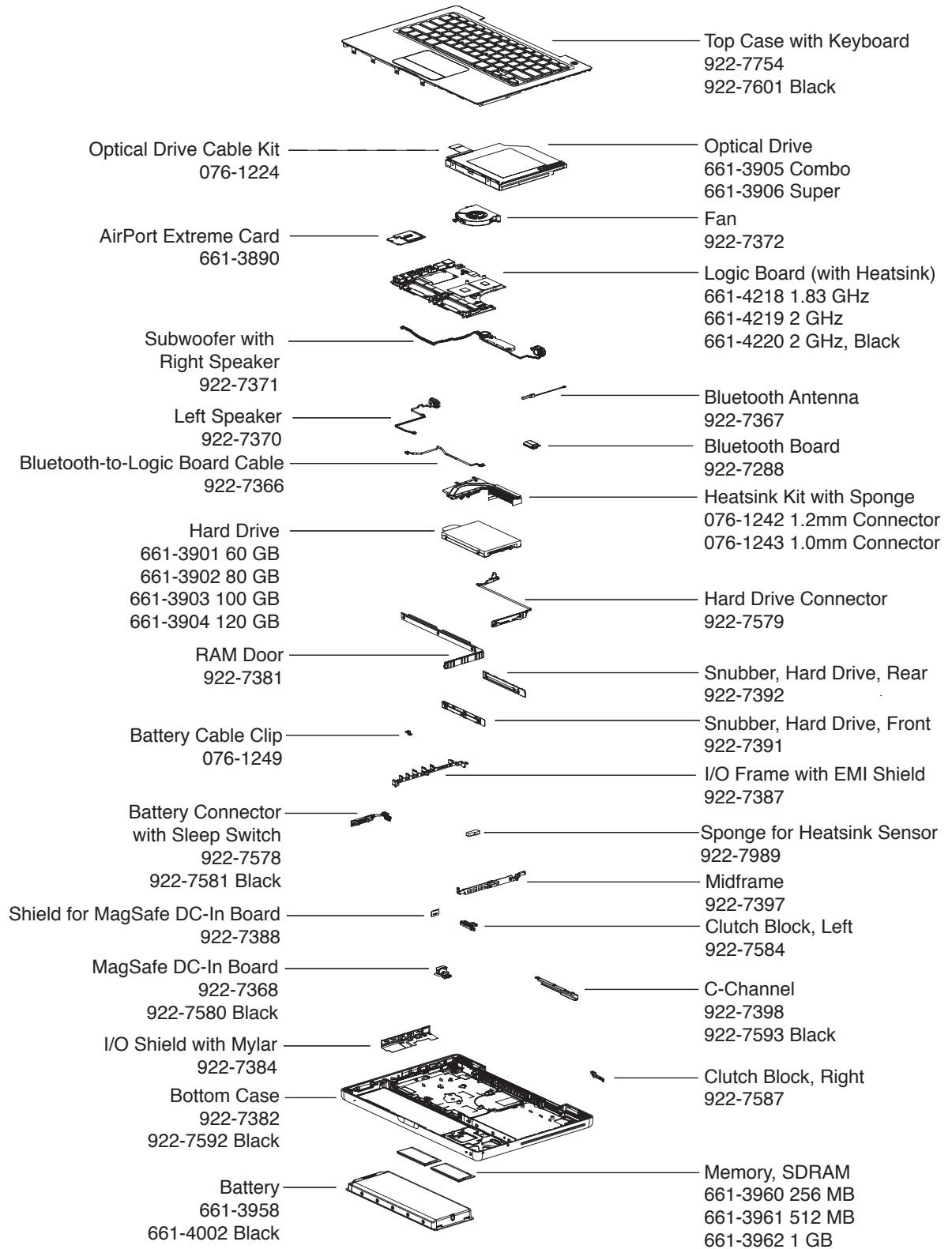

MacBook (13-inch Late 2006)—Display Exploded View

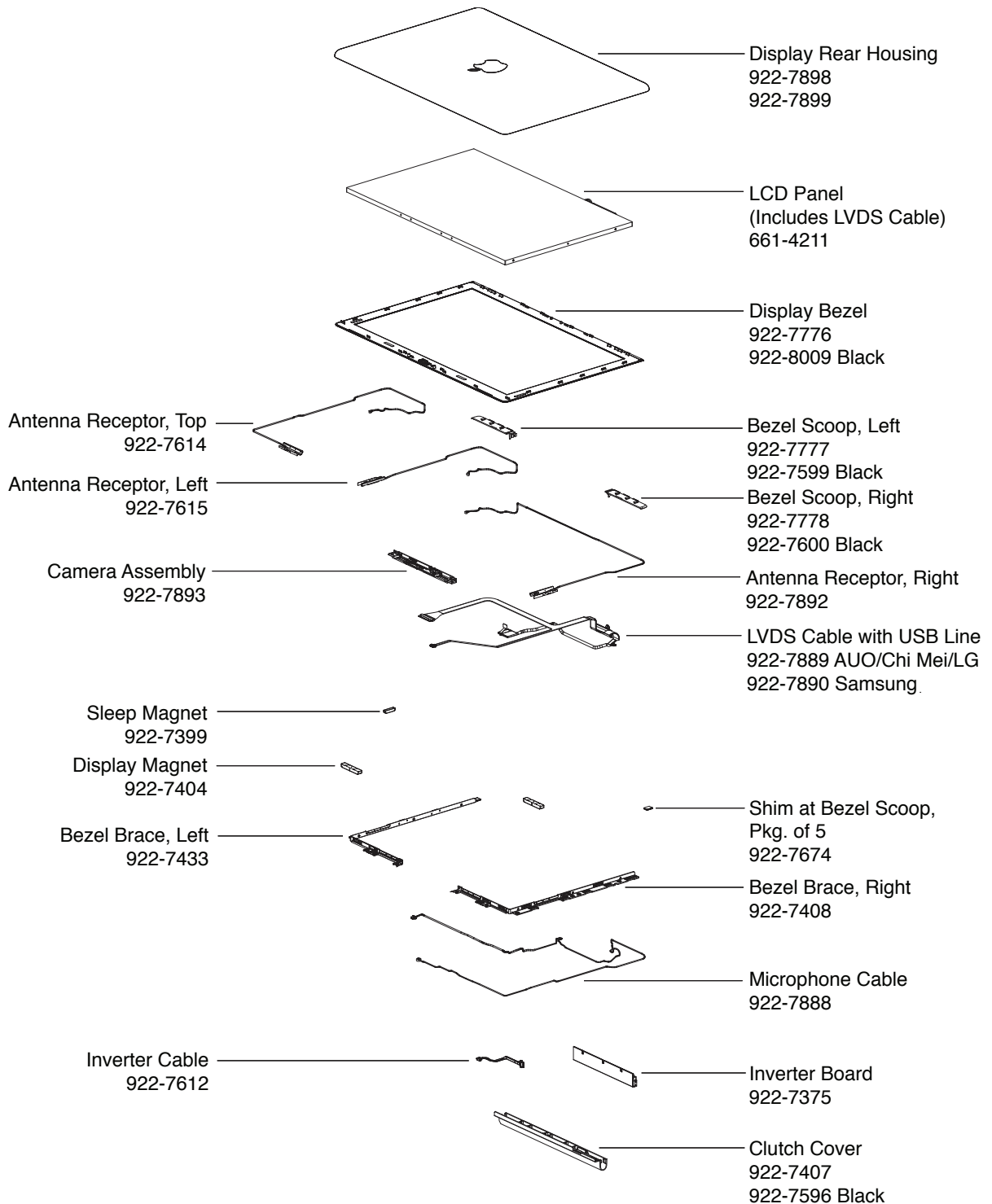

MacBook (13-inch Late 2006)—Main Exploded View

